

Gabriel®

THE ORIGINAL

20/26 CATALOG

LAST MILE DELIVERY / MEDIUM DUTY
SHOCKS & STRUTS



Gabriel.com

SCAN TO WATCH!
Explore Gabriel's lineup of premium
last mile delivery shocks & struts!



Table of Contents

Last Mile Delivery

Last Mile Delivery Shocks & Struts - Application Listing.....	3
Last Mile Delivery Shocks & Struts - Numerical Listing.....	65

Medium Duty

Medium Duty Shocks - Application Listing.....	83
Medium Duty Shocks - Numerical Listing	193

Competitive & OEM Interchange.....	212
------------------------------------	-----

End Mount Specifications.....	275
Specifications by End Mount	282
Specifications by Part Number.....	296



Last Mile Delivery

Shocks & Struts

(Alphabetical Listing)

(Numerical Listing)

Amortiguadores y Struts

**para entrega de
última final**

(Lista alfabética)

(Listado numérico)

Amortisseurs et Jambes de Force

**pour la livraison du dernier
kilomètre**

(Liste alphabétique)

(Ordre numérique)

Gabriel[®]

THE ORIGINAL



SCAN TO WATCH!

For more information
on Last Mile Delivery



Gabriel.com/LastMile

APPLICATION GUIDE

Year	Fitment Notes	OEM#								
			Fleetline\ Gas SLX	Classic\ Ultra\ ProGuard\ Guardian	Max Control\ LTV Severe Duty\ Load Carrier\ HiJackers	Steering Dampers\ Steering Stabilizer\ Cab Shock	Fleetline\ Gas SLX	Classic\ Ultra\ ProGuard\ Guardian	Max Control\ LTV Severe Duty\ Load Carrier\ HiJackers	Steering Dampers\ Steering Stabilizer\ Cab Shock

CHEVROLET 4500HD

22-25	Models with 7,000 to 8,000 lb Front Axle;	3989717C1	00	83135				
-------	---	-----------	----	-------	------	------	------	--	--	--	--

5500HD

22-25	Models with 7,000 to 8,000 lb Front Axle;	3989717C1	00	83135				
-------	---	-----------	----	-------	------	------	------	--	--	--	--

6500HD

22-25	Models with 7,000 to 8,000 lb Front Axle;	3989717C1	00	83135				
-------	---	-----------	----	-------	------	------	------	--	--	--	--

C20 PANEL

67	All		00	34036 [®]				
----	-----	--	----	------	------	--------------------	------	--	--	--	--

C30 PANEL

63-66	All		00	34036 [®]				
-------	-----	--	----	------	------	--------------------	------	--	--	--	--

C60 KODIAK

90-96	Conventional Cab w/ Front Shock with O.E.M. Number	88982682 15588554 15887728 15174898 19152843 22064230 15123676	-	83136					
	Conventional Cab w/15000, 19000, 21000 lb Multileaf Springs	15174902 88982686 22064232	-	-	85071
	Conventional Cab w/19000, 21000, 23000 lb Taperleaf Springs (EXC Low Profile Vehicle)	22064233	-	-	83136
	Truck Cabs with Link Cabmate Model GMC104TK	1201-0054 1202-0054	00	83021



C3500HD

91-02	I Beam Front Axle			00			43180 [®]	
	Exc. I Beam Front Axle			00	61543	43163 [®] 58488

C4500 KODIAK

03-09	C Chassis - Conventional Cab	88982682 15588554 15887728 19152843 22064230 15123676	-	83136					
	C Chassis - Conventional Cab w/19000, 21000, 23000 lb Taperleaf Springs (EXC Low Profile Vehicle)	22064233	-	-	83136
	C Chassis - Conventional Cab With 15000, 19000, 21000 lb Multileaf Springs	15174902 88982686 22064232	-	-	85071
	Truck Cabs with Link Cabmate Model GMC104TK	1201-0054 1202-0054	00	83021
90-02	C Chassis - Conventional Cab	88982682 15588554 15887728 19152843 22064230 15123676	-	83136					
	C Chassis - Conventional Cab w/19000, 21000, 23000 lb Taperleaf Springs (EXC Low Profile Vehicle)	22064233	-	-	83136
	C Chassis - Conventional Cab With 15000, 19000, 21000 lb Multileaf Springs	15174902 88982686 22064232	-	-	85071

APPLICATION GUIDE

Year	Fitment Notes	OEM#								
			Fleetline/ Gas SLX	Classic/ Ultra/ ProGuard/ Guardian	Max Control/ LTV Severe Duty/ Load Carrier/ HiJackers	Steering Dampers/ Steering Stabilizer/ Cab Shock	Fleetline/ Gas SLX	Classic/ Ultra/ ProGuard/ Guardian	Max Control/ LTV Severe Duty/ Load Carrier/ HiJackers	Steering Dampers/ Steering Stabilizer/ Cab Shock

CHEVROLET

CHEVROLET

C4500 KODIAK (cont)

83-99	C Chassis - Conventional Cab with 9100 to 17500 lb Rear Axle	22064432
-------	--	----------	-------	-------	-------	-------	-------	-------	-------	-------	-------	-------	-------



C5500 KODIAK

03-09	C Chassis - Conventional Cab	88982682 15588554 15887728 19152843 22064230 15123676	 T	83136	
	C Chassis - Conventional Cab w/19000, 21000, 23000 lb Taperleaf Springs (EXC Low Profile Vehicle)	22064233		 T	83136	
	C Chassis - Conventional Cab With 15000, 19000, 21000 lb Multileaf Springs	15174902 88982686 22064232		 T	85071
	Truck Cabs with Link Cabmate Model GMC104TK	1201-0054 1202-0054	O O	83021	
92-02	C Chassis - Conventional Cab	88982682 15588554 15887728 19152843 22064230 15123676	 T	83136	
	C Chassis - Conventional Cab w/19000, 21000, 23000 lb Taperleaf Springs (EXC Low Profile Vehicle)	22064233		 T	83136	
	C Chassis - Conventional Cab With 15000, 19000, 21000 lb Multileaf Springs	15174902 88982686 22064232		 T	85071	
92-99	C Chassis - Conventional Cab with 9100 to 17500 lb Rear Axle	22064432		O O	83221	
90-91	C Chassis - Conventional Cab	88982682 15588554 15887728 19152843 22064230 15123676	 T	83136	
	C Chassis - Conventional Cab w/19000, 21000, 23000 lb Taperleaf Springs (EXC Low Profile Vehicle)	22064233		 T	83136	
	C Chassis - Conventional Cab With 15000, 19000, 21000 lb Multileaf Springs	15174902 88982686 22064232		 T	85071	
	C Chassis - Conventional Cab with 9100 to 17500 lb Rear Axle	22064432		O O	83221	
	Truck Cabs with Link Cabmate Model GMC104TK	1201-0054 1202-0054	O O	83021		
83-89	C Chassis - Conventional Cab with 9100 to 17500 lb Rear Axle	22064432		O O	83221	

C7500 KODIAK

00-01	Conventional Cab w/ Front Shock with O.E.M. Number	88982682 15588554 15887728 15174898 19152843 22064230 15123676	 T	83136
	Conventional Cab w/15000, 19000, 21000 lb Multileaf Springs	15174902 88982686 22064232		 T	85071
	Conventional Cab w/19000, 21000, 23000 lb Taperleaf Springs (EXC Low Profile Vehicle)	22064233		 T	83136
	Models with Hendrickson Air Suspension (Stamping number 47902-13)	12474915 15963161		O O	83122 89406

APPLICATION GUIDE

Year	Fitment Notes	OEM#								
			Fleetline\ Gas SLX	Classic\ Ultra\ ProGuard\ Guardian	Max Control\ LTV Severe Duty\ Load Carrier\ HiJackers	Steering Dampers\ Steering Stabilizer\ Cab Shock	Fleetline\ Gas SLX	Classic\ Ultra\ ProGuard\ Guardian	Max Control\ LTV Severe Duty\ Load Carrier\ HiJackers	Steering Dampers\ Steering Stabilizer\ Cab Shock

CHEVROLET

CHEVROLET

C7500 KODIAK (cont)

00-01	Models with Hendrickson Air Suspension with O.E.M. Number	60670-005 060665-003 12474917 15740554 59057-001 47902-29			83137
	Truck Cabs with Link Cabmate Model GMC104TK	1201-0054 1202-0054		83021	

EXPRESS 4500

09-22	All			61685 G63895	61687 G63897	58638 77638
-------	-----	--	--	------	-----------------	------	------	--	------	-----------------	----------------	------

FLEETLINE

49-52	All			82026 G63610	61592 81340 82066	43140 ⁸ 49205 ⁷
-------	-----	--	--	------	-----------------	------	------	--	------	-------------------------	--	------

FLEETLINE TRUCK

49-52	All			82026 G63610	61592 81340 82066	43140 ⁸ 49205 ⁷
-------	-----	--	--	------	-----------------	------	------	--	------	-------------------------	--	------

K20 PANEL

67	All			G63306
----	-----	--	--	------	------	------	------	--	------	--------	------	------

LCF 3500

24-25	All	98381010 98232671		83515
		98380746			83159
16-23	All	98381010 98232671		83515
		98380746			83159

LCF 3500HD

18	All	98381010 98232671		83515
		98380746			83159
16-17	All	98381010 98232671		83515
		98380746			83159

LCF 4500

17-25	All	983439850 98380746			83159
	With OEM Number	98381010 98232671 893810110		83515

LCF 4500HD

17-25	All	983439850 98380746			83159
	With OEM Number	98381010 98232671 893810110		83515

LCF 4500XD

17-25	With OEM Number	98381010 893810110		83515
-------	-----------------	-----------------------	--	-------	------	------	------	--	------	------	------	------

LCF 5500XD

25	All	98380746			83159
	With OEM Number	98232671		83515
	With OEM Number 983439850	983439850			83159

APPLICATION GUIDE

Year	Fitment Notes	OEM#								
			Fleetline/ Gas SLX	Classic/ Ultra/ ProGuard/ Guardian	Max Control/ LTV Severe Duty/ Load Carrier/ HiJackers	Steering Dampers/ Steering Stabilizer/ Cab Shock	Fleetline/ Gas SLX	Classic/ Ultra/ ProGuard/ Guardian	Max Control/ LTV Severe Duty/ Load Carrier/ HiJackers	Steering Dampers/ Steering Stabilizer/ Cab Shock

CHEVROLET

CHEVROLET

LCF 5500XD (cont)

17-24	All	983439850 98380746	O	O	83159
	With OEM Number	98381010 98232671 893810110	I O	83515	O
	With OEM Number 983439850	983439850	O	O	83159

P60

92-96	Motorhome Chassis	22064233	I T	I T	83136
-------	-------------------	----------	--------	------	------	------	------	--------	-------	------	------	------

P6000

92-96	Motorhome Chassis	22064233	I T	I T	83136
-------	-------------------	----------	--------	------	------	------	------	--------	-------	------	------	------

PICKUP 3/4 TON, C20

75-86	All		O O	61525 81039 G63355	O O
	Crew Cab Pickup		O O	34036 ⁶	O O	G63366	58930
	Standard Cab Pickup		O O	34036 ⁶	O O	61524 81164 G63349	43111 ⁸ 49155 ⁷
63-86	Single System Steering Stabilizer All models with factory frame bracket. Kit 143168 required to install to linkage.		O O	6802SE ⁸⁴								
73-74	Crew Cab Pickup		O O	61525 81039 G63355	34036 ⁶	O O
	Standard Cab Pickup		O O	O O	61524 81164	43111 ⁸ 49155 ⁷
67-72	All		O O	61525 81039 G63355	34036 ⁶	O O	G63306
	Coil(RearSpringType)		O O	O O	82003	49107 ⁷
	Leaf(RearSpringType)		O O	O O	49162 ⁷
63-66	All		O O	61525 81039 G63355	34036 ⁶	O O	G63306	49162 ⁷
60-62	All		O O	82035	O O	82086

PICKUP 3/4 TON, C25 / C2500

88-00	All		I O	61544 81668 G63489	34073 ⁶ 58489 77489	O O	61543 81667 G63488	43163 ⁸ 49218 ⁷ 58488 77488
92-99	Exc. OE Unit		O O	6853SE ⁸⁶								

PICKUP 3/4 TON, K20

81-86	Exc. Lift Kit		O O	G63347	O O	61524 81164 G63349	43111 ⁸
	Quad Suspension Long Shock; Exc. Lift Kit		O O	61522 ⁶ 81496 ⁶	O O
	Quad Suspension Short Shock; Exc. Lift Kit		O O	61516 ⁶	O O
	Standard Suspension; Exc. Lift Kit		O O	81113 ⁶	O O	49155 ⁷
73-86	All		O O	14017	O O
	Single System Steering Stabilizer		O O	6804SE ⁸⁰								

6 It is recommended that when replacing shocks on vehicles with "quad shocks" all 4 shocks should be matched by series.;

8 Pair Packs.;



84 Replacement damper for vehicles with the Gabriel Aftermarket mounting kit;

7 Pair Packs, Air hose kit included.;

80 Mounting bracket not required, install on O.E. Shock Mounts. See Ref. C for optional Steering Stabilizer Boots.;

86 Exc. OE Unit;

APPLICATION GUIDE

Year	Fitment Notes	OEM#								
			Fleetline\ Gas SLX	Classic\ Ultra\ ProGuard\ Guardian	Max Control\ LTV Severe Duty\ Load Carrier\ HiJackers	Steering Dampers\ Steering Stabilizer\ Cab Shock	Fleetline\ Gas SLX	Classic\ Ultra\ ProGuard\ Guardian	Max Control\ LTV Severe Duty\ Load Carrier\ HiJackers	Steering Dampers\ Steering Stabilizer\ Cab Shock

CHEVROLET

CHEVROLET

PICKUP 3/4 TON, K20 (cont)

67-86	Dual System Steering Stabilizer All models with factory frame bracket. Kit 143168 required to install to linkage.		OO	6802SE ⁸⁴								
75-80	Exc. Lift Kit		OO	61516 ⁶ 81113 ⁶ G63347	OO	61524 81164 G63349	43111 ⁸ 49155 ⁷
73-74	Exc. Lift Kit		OO	61516 ⁶ 81113 ⁶ G63347	OO	61524 81164	43111 ⁸ 49155 ⁷
69-72	Exc. Lift Kit		OO	61516 ⁶ 81113 ⁶ G63347	OO
67-72	All		OO	OO	G63306
61-72	Single System Steering Stabilizer		OO	6803SE ⁸⁴								

PICKUP 3/4 TON, K25 / K2500

99-00	Exc. OE Unit		OO	6853SE ⁸⁶								
88-00	All		OO	61542 81726 G63609	58609 77609	OO	61543 81667 G63488	43163 ⁸ 49218 ⁷ 58488 77488

PICKUP 3/4 TON, R20

87-88	All		OO	61525 81039 G63355	OO
	Single System Steering Stabilizer All models with factory frame bracket. Kit 143168 required to install to linkage.		OO	6802SE ⁸⁴								
	Crew Cab Pickup		OO	34036 ⁸	OO	G63366	58930
87	Standard Cab Pickup		OO	OO	61524 81164 G63349	43111 ⁸ 49155 ⁷

PICKUP 3/4 TON, R2500

89	All		OO	61525 81039 G63355	34036 ⁸	OO	G63366	58930
	Single System Steering Stabilizer All models with factory frame bracket. Kit 143168 required to install to linkage.		OO	6802SE ⁸⁴								

PICKUP 3/4 TON, SILVERADO 2500

11-18	All		OO	OO	G64121
05-08	All		OO	61663 81925 G63817	58817 77817	OO	61642 81921 G63675	58412 77412
99-04	All		OO	OO	61642 81921 G63675	58412 77412
	4WD		OO	61663 81925 G63817	58817 77817	OO
	RWD, Exc. Electronic Adjustable Suspension		OO	61641 81920 G63783	77783	OO

PICKUP 3/4 TON, SILVERADO 2500 HD

11-24	All		OO	G64148	OO	G64121	43181 ⁸ 77976
-------	-----	--	----	------	--------	------	------	----	------	--------	-----------------------------	------

6 It is recommended that when replacing shocks on vehicles with "quad shocks" all 4 shocks should be matched by series.;



8 Pair Packs.;

86 Exc. OE Unit;

7 Pair Packs, Air hose kit included.;

84 Replacement damper for vehicles with the Gabriel Aftermarket mounting kit;

APPLICATION GUIDE

Year	Fitment Notes	OEM#								
			Fleetline/ Gas SLX	Classic/ Ultra/ ProGuard/ Guardian	Max Control/ LTV Severe Duty/ Load Carrier/ HiJackers	Steering Dampers/ Steering Stabilizer/ Cab Shock	Fleetline/ Gas SLX	Classic/ Ultra/ ProGuard/ Guardian	Max Control/ LTV Severe Duty/ Load Carrier/ HiJackers	Steering Dampers/ Steering Stabilizer/ Cab Shock

CHEVROLET

CHEVROLET

PICKUP 3/4 TON, SILVERADO 2500 HD (cont)

05-10	9200# GVW		I O	61663 G63817	58817 77817	I O
01-10	All		I O	I O	61642 81921 G63675	58412 77412
01-09	9200# GVW w/ OE Unit - 15059138 15155638		I O	6853SE ⁸²							
	9200# GVW w/o OE Unit - 15059138 15155638		I O	6803SE ⁸⁴							
01-04	9200# GVW		I O	61663	58817 77817	I O
	4WD, 9200# GVW		I O	G63817	I O
	RWD		I O	81920	I O

PICKUP 3/4 TON, V20

87	All		I O	14017	I O	49155 ⁷
	Dual System Steering Stabilizer All models with factory frame bracket. Kit 143168 required to install to linkage.		I O	6802SE ⁸⁴							
	Exc. Quad Suspension and Lift Kit		I O	61516 G63347	I O	61524 81164 G63349	43111 ⁸
	Quad Suspension Long Shock; Exc. Lift Kit		I O	61522 ⁵ 81496 ⁵	I O
	Single System Steering Stabilizer		I O	6804SE ⁸⁰							

PICKUP 1 TON, C30

75-86	All		I O	61525 81039 G63355	34036 ⁸	I O	G63366	58930
73-86	with Cooler		I O	6802SE ⁸⁴							
63-74	All		I O	61525 81039 G63355	34036 ⁸	I O
67-72	Exc. 11,000# Rear Axle		I O	I O	G63306	49162 ⁷
61-72	Single System Steering Stabilizer All models with factory frame bracket. Kit 143168 required to install to linkage.		I O	6802SE ⁸⁴							
61-62	All		I O	82035	I O

PICKUP 1 TON, C35/3500

98-00	Crew Cab; Exc. HD Straight Front Axle		I O	61544 G63489	58489	I O	G63488
92-00	Exc. HD Straight Front Axle		I O	81668	I O
	Exc. HD Straight Front Axle		I O	61544 G63489	58489 77489	I O	G63488
	Extended & Standard Cab; Exc. HD Straight Front Axle		I O	I O	81667
91-00	All		I O	I O	49218 ⁷ 77488
88-00	Extended & Standard Cab; Exc. Straight Front Axle		I O	34073 ⁸	I O
92-97	Crew Cab; Exc. HD Straight Front Axle		I O	61544 G63489	58489 77489	I O	G63488
88-91	Cab & Chassis Exc. HD Solid Front Axle		I O	I O	58930

6 It is recommended that when replacing shocks on vehicles with "quad shocks" all 4 shocks should be matched by series.;
8 Pair Packs.;



7 Pair Packs, Air hose kit included.;

80 Mounting bracket not required, install on O.E. Shock Mounts. See Ref. C for optional Steering Stabilizer Boots.;

82 Use kit if listed, See Ref. C for optional Steering Stabilizer Boots.;

84 Replacement damper for vehicles with the Gabriel Aftermarket mounting kit;

APPLICATION GUIDE

Year	Fitment Notes	OEM#								
			Fleetline\ Gas SLX	Classic\ Ultra\ ProGuard\ Guardian	Max Control\ LTV Severe Duty\ Load Carrier\ HiJackers	Steering Dampers\ Steering Stabilizer\ Cab Shock	Fleetline\ Gas SLX	Classic\ Ultra\ ProGuard\ Guardian	Max Control\ LTV Severe Duty\ Load Carrier\ HiJackers	Steering Dampers\ Steering Stabilizer\ Cab Shock

CHEVROLET

CHEVROLET

PICKUP 1 TON, C35/3500 (cont)

88-91	Cab & Chassis; Exc. HD Solid Front Axle		OO	61525 81039 G63355	34036 ⁸	OO	G63366
91	Extended & Standard Cab; Exc. HD Straight Front Axle		O	61544 81668 G63489	58489 77489	OO	81667 G63488
88-90	Extended & Standard Cab; Exc. HD Straight Front Axle		O	61544 81668 G63489	58489 77489	OO	61543 81667 G63488	43163 ⁸ 49218 ⁷ 58488 77488

PICKUP 1 TON, K30

77-86	All		OO	G63411	14017	OO	61642 81921 G63675	58412 77412
	Dual System Steering Stabilizer All models with factory frame bracket. Kit 143168 required to install to linkage.		OO	6802SE ⁸⁴								
	Single System Steering Stabilizer		OO	6804SE ⁸⁰								
73-74	All		OO	14017	OO

PICKUP 1 TON, K35 / K3500

95-00	Exc. OE Unit		OO	6853SE ⁸⁶								
88-00	All		OO	61542 81726 G63609	58609 77609	OO	61543 81667 G63488	43163 ⁸ 49218 ⁷ 58488 77488

PICKUP 1 TON, R30

87-88	All		OO	61525 81039 G63355	34036 ⁸	OO	G63366	58930
	with Cooler		OO	6802SE ⁸⁴								

PICKUP 1 TON, R3500

90-91	All		OO	81039 G63411	14017	OO	61642 81921 G63675	58412 77412
89-91	with Cooler		OO	6802SE ⁸⁴								
89	All		OO	81039	14017	OO
	Exc. Standard Cab		OO	G63411	OO	61642 81921 G63675	58412 77412
	Standard Cab Pickup		OO	61525 G63355	34036 ⁸	OO	G63366	58930

PICKUP 1 TON, SILVERADO 3500

15-18	All		OO	OO	G64121
11-13	All		OO	OO	G64121
01-09	All		O	61663 81925 G63817	58817 77817	OO	61642 81921 G63675	58412 77412

PICKUP 1 TON, SILVERADO 3500 HD

11-24	All		OO	G64148	OO	G64121	43181 ⁸ 77976
08-10	All		O	61663 G63817	58817 77817	OO	61642 81921 G63675	58412 77412

7 Pair Packs, Air hose kit included.;

80 Mounting bracket not required, install on O.E. Shock Mounts. See Ref. C for optional Steering Stabilizer Boots;;

86 Exc. OE Unit;

8 Pair Packs.;

84 Replacement damper for vehicles with the Gabriel Aftermarket mounting kit;

APPLICATION GUIDE

Year	Fitment Notes	OEM#								
			Fleetline/ Gas SLX	Classic/ Ultra/ ProGuard/ Guardian	Max Control/ LTV Severe Duty/ Load Carrier/ HiJackers	Steering Dampers/ Steering Stabilizer/ Cab Shock	Fleetline/ Gas SLX	Classic/ Ultra/ ProGuard/ Guardian	Max Control/ LTV Severe Duty/ Load Carrier/ HiJackers	Steering Dampers/ Steering Stabilizer/ Cab Shock

CHEVROLET

CHEVROLET

PICKUP 1 TON, SILVERADO 3500 HD (cont)

07	All		I O	61663 G63817	58817 77817		I O	61642 G63675	58412
	Classic		I O		I O	77412

PICKUP 1 TON, V30

87-88	All		I O	G63411	14017		I O	61642 81921 G63675	58412 77412
-------	-----	--	--------	------	--------	------	-------	--	--------	------	--------------------------	----------------	------

PICKUP 1 TON, V3000 / V3500

89-91	All		I O	G63411	14017		I O	61642 81921 G63675	58412 77412
-------	-----	--	--------	------	--------	------	-------	--	--------	------	--------------------------	----------------	------

SILVERADO 2500 HD CLASSIC

07	All		I O	61663 G63817	77817		I O	61642 G63675	58412 77412
	9200# GVW		I O	58817		I O

SILVERADO 3500 CLASSIC

07	All		I O		I O	81921	58412
	Heavy Duty		I O	58817		I O

SILVERADO 4500 HD

23-24	Models with 11K, 13.5K or 15.5K VARI-RATE Rear Suspension	4208946C1			I O	83398
	Models with Taperleaf Front	4089293C1	I O	83397		I O
22-24	Models with 4X4 Rear	4109458C2			I O	83243
19-24	Models with IROS Rear	4214011C2			I O	85670
19-22	Diesel Low Cab Forward models with 14,000 to 15,000 lb Rear	8983807460 8-98380-746-0			I O	83159
	Diesel Low Cab Forward models with 14,500 lb GVWR	8983810100	I O	83515		I O
	Diesel Low Cab Forward models with 15,000 to 16,000 lb Rear	8983807470			I O	83159
	Diesel Low Cab Forward models with 16,000 lb to 19,500 lb GVWR	8983810120	I O	83515		I O
	Models with 11K, 13.5K or 15.5K VARI-RATE Rear Suspension	4208946C1 4206863C1			I O	83398
	Models with 7,000 to 8,000 lb Front Axle	3989717C1	I O	83135		I O
	Models with Taperleaf Front	4109582C1 4089293C1 4109583C1 4207304C1	I O	83397		I O
19-21	Models with 4 x 4 Rear	4109458C2			I O	83243



SILVERADO 4500HD

25	Models with 11K, 13.5K, 15.5K Vari-Rate	4208946C1			I O	83398
	Models with 4X4 Rear	4109458C2			I O	83243
	Models with IROS Rear	4214011C2			I O	85670
	Models with Taperleaf Front	4089293C1	I O	83397		I O

SILVERADO 5500 HD

23-24	Models with 4X4 Rear	4109458C2			I O	83243
19-24	Models with IROS Rear	4214011C2			I O	85670
24	Models with 11K, 13.5K or 15.5K VARI-RATE Rear Suspension	4208946C1			I O	83398

APPLICATION GUIDE

Year	Fitment Notes	OEM#								
			Fleetline\ Gas SLX	Classic\ Ultra\ ProGuard\ Guardian	Max Control\ LTV Severe Duty\ Load Carrier\ HiJackers	Steering Dampers\ Steering Stabilizer\ Cab Shock	Fleetline\ Gas SLX	Classic\ Ultra\ ProGuard\ Guardian	Max Control\ LTV Severe Duty\ Load Carrier\ HiJackers	Steering Dampers\ Steering Stabilizer\ Cab Shock

CHEVROLET

CHEVROLET

SILVERADO 5500 HD (cont)

24	Models with Taperleaf Front	4089293C1		83397
19-23	Models with 11K, 13.5K or 15.5K VARI-RATE Rear Suspension	4208946C1 4206863C1			83398
	Models with Taperleaf Front	4109582C1 4089293C1 4109583C1 4207304C1		83397
19-22	Diesel Low Cab Forward models with 14,000 to 15,000 lb Rear	8983807460 8-98380-746-0			83159
	Diesel Low Cab Forward models with 14,500 lb GVWR	8983810100		83515
	Diesel Low Cab Forward models with 15,000 to 16,000 lb Rear	8983807470			83159
	Diesel Low Cab Forward models with 16,000 lb to 19,500 lb GVWR	8983810120		83515
	Models with 4 x 4 Rear	4109458C2			83243
	Models with 7,000 to 8,000 lb Front Axle	3989717C1		83135

SILVERADO 5500HD

25	Models with 11K, 13.5K, 15.5K Vari-Rate	4208946C1			83398
	Models with 4X4 Rear	4109458C2			83243
	Models with IROS Rear	4214011C2			85670
	Models with Taperleaf Front	4089293C1		83397

SILVERADO 6500 HD

23-24	Models with 4X4 Rear	4109458C2			83243
19-24	Models with IROS Rear	4214011C2			85670
24	Models with 11K, 13.5K or 15.5K VARI-RATE Rear Suspension	4208946C1			83398
	Models with Taperleaf Front	4089293C1		83397
19-23	Models with 11K, 13.5K or 15.5K VARI-RATE Rear Suspension	4208946C1 4206863C1			83398
	Models with Taperleaf Front	4109582C1 4089293C1 4109583C1 4207304C1		83397
19-22	Models with 4 x 4 Rear	4109458C2			83243
	Models with 7,000 to 8,000 lb Front Axle	3989717C1		83135



SILVERADO 6500HD

25	Models with 11K, 13.5K, 15.5K Vari-Rate	4208946C1			83398
	Models with 4X4 Rear	4109458C2			83243
	Models with IROS Rear	4214011C2			85670
	Models with Taperleaf Front	4089293C1		83397

T5500

97-09	FL1 Tilt Cab with 8100 lb Axle	22165188 22165187 22064804 22064805		83136
	FL2 Tilt Cab with 5000 to 11000 lb Axle	22166442 22064807		83136
	FL3 Tilt Cab with 14575 lb Axle	22165189 22064806		83136
90-06	Tilt Cab w/15000, 19000, 21000 lb Multileaf Springs	15174902 22064232			85071

APPLICATION GUIDE

Year	Fitment Notes	OEM#								
			Fleetline/ Gas SLX	Classic/ Ultra/ ProGuard/ Guardian	Max Control/ LTV Severe Duty/ Load Carrier/ HiJackers	Steering Dampers/ Steering Stabilizer/ Cab Shock	Fleetline/ Gas SLX	Classic/ Ultra/ ProGuard/ Guardian	Max Control/ LTV Severe Duty/ Load Carrier/ HiJackers	Steering Dampers/ Steering Stabilizer/ Cab Shock

CHEVROLET

T5500 (cont)

CHEVROLET

92-99	Tilt Cab w/19000, 21000, 23000 lb Taperleaf Springs (EXC Low Profile Veh.)	22064233	I T	83136
-------	--	----------	------	------	------	------	--------	-------	------	------	------



T6500

06-09	15,000lb; 17,000lb; 19,000lb; 21,000lb and 23,000lb Axle	88982687	I T	85705
04-09	FL1 Tilt Cab with 8100 lb Axle	22165188 22165187 22064804 22064805	I T	83136
	FL2 Tilt Cab with 5000 to 11000 lb Axle	22166442 22064807	I T	83136
	FL3 Tilt Cab with 14575 lb Axle	22165189 22064806	I T	83136
04-05	Tilt Cab w/15000, 19000, 21000 lb Multileaf Springs	15174902 22064232	I T	85071
03	FL1 Tilt Cab with 8100 lb Axle	22165188 22165187 22064804 22064805	I T	83136
	FL2 Tilt Cab with 5000 to 11000 lb Axle	22166442 22064807	I T	83136
	FL3 Tilt Cab with 14575 lb Axle	22165189 22064806	I T	83136
	Tilt Cab w/15000, 19000, 21000 lb Multileaf Springs	15174902 22064232	I T	85071
00-02	Low profile, with Axle Code FL1	22165187	O O	83163
	Tilt Cab with 23,000 lb Axles; Tapered Leaf Spring	22064233	I T	83136
	with 16,900lb Axle. Tapered Leaf Springs	22064489	I O	85332
	With Hendrickson Air Suspension	15963161 12474917	O O	85013
97-02	FL1 Tilt Cab with 8100 lb Axle	22165188 22165187 22064804 22064805	I T	83136
	FL2 Tilt Cab with 5000 to 11000 lb Axle	22166442 22064807	I T	83136
	FL3 Tilt Cab with 14575 lb Axle	22165189 22064806	I T	83136
	Tilt Cab w/15000, 19000, 21000 lb Multileaf Springs	15174902 22064232	I T	85071
97-99	Tilt Cab w/19000, 21000, 23000 lb Taperleaf Springs (EXC Low Profile Veh.)	22064233	I T	83136
99	Models with Hendrickson Air Suspension (Stamping number 47902-13)	12474915 15963161	O O	83122 89406
92-96	Tilt Cab w/19000, 21000, 23000 lb Taperleaf Springs (EXC Low Profile Veh.)	22064233	I T	83136
90-96	Tilt Cab w/15000, 19000, 21000 lb Multileaf Springs	15174902 22064232	I T	85071

T7500

06-09	15,000lb; 17,000lb; 19,000lb; 21,000lb and 23,000lb Axle	88982687	I T	85705
04-09	FL1 Tilt Cab with 8100 lb Axle	22165188 22165187 22064804 22064805	I T	83136
	FL2 Tilt Cab with 5000 to 11000 lb Axle	22166442 22064807	I T	83136
	FL3 Tilt Cab with 14575 lb Axle	22165189 22064806	I T	83136
04-05	Tilt Cab w/15000, 19000, 21000 lb Multileaf Springs	15174902 22064232	I T	85071
00-02	Low profile, with Axle Code FL1	22165187	O O	83163

APPLICATION GUIDE

Year	Fitment Notes	OEM#								
			Fleetline\ Gas SLX	Classic\ Ultra\ ProGuard\ Guardian	Max Control\ LTV Severe Duty\ Load Carrier\ HiJackers	Steering Dampers\ Steering Stabilizer\ Cab Shock	Fleetline\ Gas SLX	Classic\ Ultra\ ProGuard\ Guardian	Max Control\ LTV Severe Duty\ Load Carrier\ HiJackers	Steering Dampers\ Steering Stabilizer\ Cab Shock

CHEVROLET

CHEVROLET

T7500 (cont)

00-02	Tilt Cab with 23,000 lb Axles; Tapered Leaf Spring	22064233	83136
	with 16,900lb Axle. Tapered Leaf Springs	22064489	85332
	With Hendrickson Air Suspension	15963161 12474917	85013
97-02	FL1 Tilt Cab with 8100 lb Axle	22165188 22165187 22064804 22064805	83136
	FL2 Tilt Cab with 5000 to 11000 lb Axle	22166442 22064807	83136
	FL3 Tilt Cab with 14575 lb Axle	22165189 22064806	83136
	Tilt Cab w/15000, 19000, 21000 lb Multileaf Springs	15174902 22064232	85071
97-99	Tilt Cab w/19000, 21000, 23000 lb Taperleaf Springs (EXC Low Profile Veh.)	22064233	83136
99	Models with Hendrickson Air Suspension (Stamping number 47902-13)	12474915 15963161	83122 89406

T8500

06-09	15,000lb;17,000lb; 19,000lb; 21,000lb and 23,000lb Axle]	88982687	85705
04-09	FL1 Tilt Cab with 8100 lb Axle	22165188 22165187 22064804 22064805	83136
	FL2 Tilt Cab with 5000 to 11000 lb Axle	22166442 22064807	83136
	FL3 Tilt Cab with 14575 lb Axle	22165189 22064806	83136
	Models with Hendrickson Air Suspension (Stamping number 47902-13)	12474915 15963161	83122 89406
04-05	Tilt Cab w/15000, 19000, 21000 lb Multileaf Springs	15174902 22064232	85071

VAN 1/2 TON, G / EXPRESS

78-95	All		...	61517 G63357 ⁵	58357	61522 81496 ⁶ G63413	49212 ⁷	...
70-95	Single System Steering Stabilizer All models with factory frame bracket. Kit 143168 required to install to linkage.		...	6802SE ⁸⁴						
71-77	All		...	61517 G63357 ⁵	58357	G63306	49162 ⁷	...
67-70	All		G63306	49162 ⁷	...
70	Independent Front Suspension		...	61517 G63357 ⁵	58357
64-66	All		82003

VAN 1/2 TON, P SERIES

74-80	All		...	61525 81039 G63355	34036 ⁸	G63366	58930 77662	...
73	All		...	61525 81039 G63355	34036 ⁸	61524 81164 G63349	43111 ⁸ 49155 ⁷	...
67-72	All		...	61525 81039 G63355	34036 ⁸	82003	49107 ⁷	...

5 Use kit No. 140719 to replace O.E. hardware for lower shock absorber mounting when studs break or self-tapping screws are not longer useable.;



7 Pair Packs, Air hose kit included.;

84 Replacement damper for vehicles with the Gabriel Aftermarket mounting kit;

6 It is recommended that when replacing shocks on vehicles with "quad shocks" all 4 shocks should be matched by series.;

8 Pair Packs.;

APPLICATION GUIDE

Year	Fitment Notes	OEM#								
			Fleetline/ Gas SLX	Classic/ Ultra/ ProGuard/ Guardian	Max Control/ LTV Severe Duty/ Load Carrier/ HiJackers	Steering Dampers/ Steering Stabilizer/ Cab Shock	Fleetline/ Gas SLX	Classic/ Ultra/ ProGuard/ Guardian	Max Control/ LTV Severe Duty/ Load Carrier/ HiJackers	Steering Dampers/ Steering Stabilizer/ Cab Shock

CHEVROLET

CHEVROLET

VAN 1/2 TON, P SERIES (cont)

63-66	All			61525 81039 G63355	34036 ⁶	G63306	49162 ⁷
61-62	All				82035			82086

VAN 3/4 TON, G / EXPRESS

23-24	All	PC3Z-18124-SDA, PC3Z-18124-BBA, PC3Z-18124-BCA, PC3Z-18124-BFA, PC3Z-18124-DAA, PC3Z-18124-SAA, PC3Z-18124-DBA, PC3Z-18124-SCA		58638
24	All		I	O	61685 G63895	I	O	61687 G63897	77638
17-23	All		I	O	61685 G63895	I	O	61687 G63897	43180 ⁸ 77638
10-16	All		I	O	61685	I	O	61687 G63897	43180 ⁸ 77638
03-16	Coil(FrontSpringType)		I	O	G63895	I	O
10-12	Torsion Bar (FrontSpringType)		I	O	G63893	I	O
07-09	All		I	O	I	O	61687 G63897	43180 ⁸ 58638 77638
03-09	Torsion Bar (FrontSpringType)		I	O	61683 G63893	I	O
03-06	All		I	O	I	O	61687 G63897	43180 ⁸ 77638
96-02	Exc. 8600# GVW		I	O	61555 81713 ⁵ G63375 ⁵	34073 ⁶ 77375	I	O	61565 G63638	43180 ⁸ 49231 ⁷ 58638 77638
78-95	All		I	O	G63357 ⁵	I	O
	Exc. 8600# GVW		I	O	61517	58357	I	O	61522 81496 ⁶ G63413	49212 ⁷
70-95	Single System Steering Stabilizer All models with factory frame bracket. Kit 143168 required to install to linkage.		I	O	6802SE ⁸⁴							
71-77	All		I	O	61517 G63357 ⁵	58357	I	O	G63306	49162 ⁷
70	All		I	O	58357	I	O	G63306	49162 ⁷
	Independent Front Suspension		I	O	61517 G63357 ⁵	I	O
67-69	All		I	O	I	O	G63306	49162 ⁷

VAN 3/4 TON, P SERIES

79-89	All			61525 81039 G63355	34036 ⁶	G63366	58930 77662
73-78	All				61525 81039 G63355	34036 ⁶			61524 81164 G63349	43111 ⁸ 49155 ⁷
68-72	All				61525 81039 G63355	34036 ⁶			G63306	49162 ⁷
63-67	All				82047
61-62	All				82047			82155	43140 ⁸ 49203 ⁷

5 Use kit No. 140719 to replace O.E. hardware for lower shock absorber mounting when studs break or self-tapping screws are not longer useable.;



7 Pair Packs, Air hose kit included.;

14 84 Replacement damper for vehicles with the Gabriel Aftermarket mounting kit;

6 It is recommended that when replacing shocks on vehicles with "quad shocks" all 4 shocks should be matched by series.;

8 Pair Packs.;

APPLICATION GUIDE

Year	Fitment Notes	OEM#								
			Fleetline\ Gas SLX	Classic\ Ultra\ ProGuard\ Guardian	Max Control\ LTV Severe Duty\ Load Carrier\ HiJackers	Steering Dampers\ Steering Stabilizer\ Cab Shock	Fleetline\ Gas SLX	Classic\ Ultra\ ProGuard\ Guardian	Max Control\ LTV Severe Duty\ Load Carrier\ HiJackers	Steering Dampers\ Steering Stabilizer\ Cab Shock

CHEVROLET

CHEVROLET

VAN 1 TON, G / EXPRESS

25	All		61687
23-24	All	PC3Z-18124-SDA, PC3Z-18124-BBA, PC3Z-18124-BCA, PC3Z-18124-BFA, PC3Z-18124-DAA, PC3Z-18124-SAA, PC3Z-18124-DBA, PC3Z-18124-SCA	58638
24	All		61685 G63895	G63897	77638
17-23	All		61685 G63895	61687 G63897	43180 ⁸ 77638
13-16	All		61685	61687 G63897	43180 ⁸ 77638
03-16	Coil(FrontSpringType)		G63895
10-12	All		61685	43180 ⁸ 58638 77638
03-12	Single Rear Wheels		61687 G63897
	Torsion Bar (FrontSpringType)		G63893
07-09	All		43180 ⁸ 77638
03-06	All		43180 ⁸ 58638 77638
97-02	All		61555 81713 ⁵ G63375 ⁵	77375	61565	43180 ⁸ 49231 ⁷
	Exc. 8600# GVW		34073 ⁸	G63638
96	All		61517 61555 81713 ⁵ G63357 G63375 ⁵	58357 77375	43180 ⁸ 49231 ⁷
	Exc. 8600# GVW		34073 ⁸	61565
	Cutaway Van		58357	G63671
94-95	HD with Straight Front Axle & Tilt Hood		6804SE ⁸⁰								
92-95	9200# GVW		77403
	Cutaway Van		61522 81496 ⁶ G63671	49212 ⁷ 58403
78-95	All		61517 G63357	58357
	Exc. Cutaway Van		G63413
71-95	Single System Steering Stabilizer All models with factory frame bracket. Kit 143168 required to install to linkage.		6802SE ⁸⁴								
79-91	9200# GVW		G63403	77403
	Cutaway Van		61522 81496 ⁶	49212 ⁷ 58403
78	Cutaway Van		61522 81496 ⁶	49212 ⁷
76-77	All		G63357	G63306	49162 ⁷
75	110.0 / 279.4(WheelBase)		G63306	49162 ⁷

5 Use kit No. 140719 to replace O.E. hardware for lower shock absorber mounting when studs break or self-tapping screws are not longer useable.;

7 Pair Packs, Air hose kit included.;



80 Mounting bracket not required, install on O.E. Shock Mounts. See Ref. C for optional Steering Stabilizer Boots.;

6 It is recommended that when replacing shocks on vehicles with "quad shocks" all 4 shocks should be matched by series.;

8 Pair Packs.;

84 Replacement damper for vehicles with the Gabriel Aftermarket mounting kit;

APPLICATION GUIDE

Year	Fitment Notes	OEM#								
			Fleetline/ Gas SLX	Classic/ Ultra/ ProGuard/ Guardian	Max Control/ LTV Severe Duty/ Load Carrier/ HiJackers	Steering Dampers/ Steering Stabilizer/ Cab Shock	Fleetline/ Gas SLX	Classic/ Ultra/ ProGuard/ Guardian	Max Control/ LTV Severe Duty/ Load Carrier/ HiJackers	Steering Dampers/ Steering Stabilizer/ Cab Shock

CHEVROLET

CHEVROLET

VAN 1 TON, G / EXPRESS (cont)

75	125.0 / 317.5(WheelBase)		O	O	O	O	G63306	49162 ⁷
	146.0 / 370.8(WheelBase)		O	O	61517 G63357	58357	O	O
71-74	All		O	O	61517 G63357	58357	O	O	G63306	49162 ⁷

VAN 1 TON, P SERIES

86-99	Motorhome Chassis w/ I-Beam Front Suspension		O	O	G63625	O	O
85-99	Motorhome Chassis w/ Independent Front Suspension		O	O	G63394	O	O
73-99	All		O	O	O	O	G63366	58930
92-96	Motorhome Chassis	22064233	I	T	I	T	83136
85-93	w/ I-Beam Front Suspension		O	O	6804SE ⁸⁰				O	O
73-90	Cutaway Chassis		O	O	61525 81039 G63355	34036 ⁸	O	O
85	Motorhome Chassis w/ I-Beam Front Suspension		O	O	G63403	58403 77403	O	O
74-84	Motorhome Chassis		O	O	G63394	O	O
68-72	All		O	O	34036 ⁸	O	O
	Cutaway Chassis		O	O	61525 81039 G63355	O	O
	Exc. 11,000# Rear Axle		O	O	O	O	G63306	49162 ⁷
63-67	All		O	O	82047	O	O
61-62	All		O	O	82047	I	O	82155	43140 ⁸ 49203 ⁷

W4500 TILTMASTER

87-10	Models with 11000 lb & 13000 lb Suspension	9516306471 97083029 94454987 98232671 97083027 8972536200 8-94454-986-0 8-94454-987-0 97253620 8-97253-620-0 8944549870 8944549860	I	O	83515	O	O
-------	--	---	---	---	-------	-------	-------	-------	---	---	-------	-------	-------	-------

W5500 TILTMASTER

88-10	Models with 11000 lb & 13000 lb Suspension	97253620	I	O	83515	O	O
-------	--	----------	---	---	-------	-------	-------	-------	---	---	-------	-------	-------	-------

W6500 TILTMASTER

87-96	Models with 11000 lb & 13000 lb Suspension	1-51630-168-1	I	O	83515	O	O
-------	--	---------------	---	---	-------	-------	-------	-------	---	---	-------	-------	-------	-------

DODGE

DODGE

M300

74	All		O	O	O	O	82065
----	-----	--	---	---	-------	-------	-------	-------	---	---	-------	-------	-------	-------

M350



74	All		O	O	O	O	82065
----	-----	--	---	---	-------	-------	-------	-------	---	---	-------	-------	-------	-------

7 Pair Packs, Air hose kit included.;

8 Pair Packs.;

80 Mounting bracket not required, install on O.E. Shock Mounts. See Ref. C for

APPLICATION GUIDE

Year	Fitment Notes	OEM#								
			Fleetline\ Gas SLX	Classic\ Ultra\ ProGuard\ Guardian	Max Control\ LTV Severe Duty\ Load Carrier\ HiJackers	Steering Dampers\ Steering Stabilizer\ Cab Shock	Fleetline\ Gas SLX	Classic\ Ultra\ ProGuard\ Guardian	Max Control\ LTV Severe Duty\ Load Carrier\ HiJackers	Steering Dampers\ Steering Stabilizer\ Cab Shock

DODGE

DODGE

PICKUP 3/4 TON, D200 SERIES

82-93	All		81091 G63353	49149 ⁷	...
	Exc. Heavy Duty Package		...	61523 ³⁵ 81096 ³⁵ G63359 ³⁵	34052 ⁸ 58359 ³⁵
	Heavy Duty Package		...	81834 G63360 ³⁵
73-93	Single System Steering Stabilizer All models with factory frame bracket. Kit 143168 required to install to linkage.		6802SE ⁸⁴							
75-81	Heavy Duty Package		...	G63360 ³⁵
	165.0 / 419.1(WheelBase) Heavy Duty Package		...	81834
81	All		81091 G63353
	Exc. Heavy Duty Package		...	61523 ³⁵ 81096 ³⁵ G63359 ³⁵	34052 ⁸ 58359 ³⁵	49149 ⁷	...
72-80	All		81091 G63353	49149 ⁷	...
	Exc. Heavy Duty Package		...	61523 ³⁵ 81096 ³⁵ G63359 ³⁵	34052 ⁸ 58359 ³⁵
72-74	Heavy Duty Package		...	81834 G63360 ³⁵
60-71	with I Beam Axle		6802SE ⁸⁴							
60	All		...	82065

PICKUP 3/4 TON, W200 SERIES

90-93	Single System Steering Stabilizer All models with factory frame bracket. Kit 143168 required to install to linkage.		6802SE ⁸⁴							
81-93	Exc. Crew Cab & Lift Kit		...	61632 81825 G63183	81342
69-89	Single System Steering Stabilizer		6803SE ⁸⁴							
60-86	Exc. Vacuum Servo Mounted on Drivers Side of Axle		6802SE ⁸⁴							
72-80	All		...	61632 81825 G63183	81342
69-71	All		...	61632 81825 G63183
61-67	All		...	61632 81825 G63183
60-67	Single System Steering Stabilizer		6803SE ⁸⁴							
60	All		...	82065

PICKUP 1 TON, D300 SERIES

75-93	Single System Steering Stabilizer All models with factory frame bracket. Kit 143168 required to install to linkage.		6802SE ⁸⁴							
72-93	All		81091 G63353	49149 ⁷	...
	Heavy Duty Package		...	81834 G63360 ³⁵
72-74	with Coil Spring Front Suspension		6802SE ⁸⁴							

7 Pair Packs, Air hose kit included.;

35 Slight grinding of control arm opening is required to install product made before Aug 1988.;

8 Pair Packs.;

84 Replacement damper for vehicles with the Gabriel Aftermarket mounting kit;

APPLICATION GUIDE

Year	Fitment Notes	OEM#								
			Fleetline/ Gas SLX	Classic/ Ultra/ ProGuard/ Guardian	Max Control/ LTV Severe Duty/ Load Carrier/ HiJackers	Steering Dampers/ Steering Stabilizer/ Cab Shock	Fleetline/ Gas SLX	Classic/ Ultra/ ProGuard/ Guardian	Max Control/ LTV Severe Duty/ Load Carrier/ HiJackers	Steering Dampers/ Steering Stabilizer/ Cab Shock

DODGE

DODGE

PICKUP 1 TON, D300 SERIES (cont)

61-71	All										
60-71	with I Beam Axle							6802SE ⁸⁴			

PICKUP 1 TON, W300 SERIES

90-93	Single System Steering Stabilizer All models with factory frame bracket. Kit 143168 required to install to linkage.										
81-93	Exc. Quad Suspension and Lift Kit			61632 81825 G63183	77948	77948	77948	77948	77948	77948	77948
60-89	Single System Steering Stabilizer							6803SE ⁸⁴			
60-86	Exc. Vacuum Servo Mounted on Drivers Side of Axle							6802SE ⁸⁴			
72-80	All			61632 81825 G63183				81342			
61-71	All			61632 81825 G63183				61632 81825 G63183			

PICKUP 3/4 TON, RAM 2500 (SEE RAM 2500)

07-10	4WD										
03-10	All			61714 G64011	77948	77948	77948	77948	77948	77948	77948
	4WD, 8800# GVW							G64013			
	RWD			G64043							
	RWD, Crew Cab Pickup							61710 G63971			
00-07	4WD; With OEM # 52106909AB, AC, AD							6847SE ⁸²			
06	4WD			61714 G64011				61716			
	4WD; Exc. 5.7L				77948	77948	77948				
	4WD; w/5.7L				77980	77980	77980				
04-05	4WD			61714 G64011	77948	77948	77948	61716			
03	Exc. 8800# GVW							61600 G63662			
	4WD				77948	77948	77948	61716			
99-02	4WD, Exc. 8800# GVW			61634 81919 G63673	77673	77673	77673				
94-02	Exc. 8800# GVW							61600 G63662	49235 ⁷ 58662 77662		
	4WD, 8800# GVW			61635 G63674	77674	77674	77674	61642 81921 G63675	77675		
	RWD			61599 81928 G63661	77661	77661	77661				
96-98	4WD, Exc. 8800# GVW			61634 G63673	77673	77673	77673				
94-97	4WD; With OEM 52038276							6804SE ⁸⁰			
94-95	4WD, Exc. 8800# GVW			61634 81919 G63673	77673	77673	77673				



7 Pair Packs, Air hose kit included.;

82 Use kit if listed, See Ref. C for optional Steering Stabilizer Boots.;

80 Mounting bracket not required, install on O.E. Shock Mounts. See Ref. C for optional Steering Stabilizer Boots.;

84 Replacement damper for vehicles with the Gabriel Aftermarket mounting kit;

APPLICATION GUIDE

Year	Fitment Notes	OEM#								
			Fleetline/ Gas SLX	Classic/ Ultra/ ProGuard/ Guardian	Max Control/ LTV Severe Duty/ Load Carrier/ HiJackers	Steering Dampers/ Steering Stabilizer/ Cab Shock	Fleetline/ Gas SLX	Classic/ Ultra/ ProGuard/ Guardian	Max Control/ LTV Severe Duty/ Load Carrier/ HiJackers	Steering Dampers/ Steering Stabilizer/ Cab Shock

DODGE

DODGE

PICKUP 1 TON, RAM 3500 (SEE RAM 3500)

08-10	RWD, Crew Cab Pickup			G63971
07-10	4WD			G63673	77948
03-10	All			77950
	RWD			G64043
03-07	RWD, Crew Cab Pickup			61710 G63971
00-07	4WD; With OEM # 52106909AB, AC, AD			6847SE ⁸²							
	RWD; With OEM # 52106909AB, AC, AD and Solid Front Axle			6847SE ⁸²							
06	4WD			G63673
	4WD, Exc. 5.9L			77948
	4WD; w/5.7L			77980
03-05	4WD			G63673	77948
94-02	4WD			61635 G63674	77674	61642 81921 G63675	77675
	RWD, Exc. Solid Front Axle			61599 81928 G63661	77661	61600 G63662	43181 ⁸ 49235 ⁷ 58662 77662
	RWD, Solid Front Axle			61635 G63674	77674	61642 81921 G63675	77675
94-97	4WD; With OEM 52038276			6804SE ⁸⁰							
	RWD; w/ OEM 52038276 Solid Front Axle			6804SE ⁸⁰							

SPRINTER 2500

07-09	All			G57802 ⁴⁰
	Single Rear Wheels			G63918
03-06	All			G56778
	Exc. Dual Rear Wheels			G63918

SPRINTER 3500

07-09	All			G57802 ⁴⁰
	Single Rear Wheels			G63918
03-06	All			G56778
	Exc. Dual Rear Wheels			G63918

VAN 1/2 TON, A / B SERIES / RAM

99-03	109.3 / 277.6(WheelBase) Exc. 7000# GVW			61523 ³⁵ 81096 ³⁵ G63359 ³⁵	34052 ⁸ 58359 ³⁵	61522 ⁶ 81496 G63413	43085 ⁸ 49212 ⁷
82-98	109.6 / 278.4(WheelBase) Exc. 7000# GVW			61523 ³⁵ 81096 ³⁵ G63359 ³⁵	34052 ⁸ 58359 ³⁵	61522 ⁶ 81496 G63413	43085 ⁸ 49212 ⁷

6 It is recommended that when replacing shocks on vehicles with "quad shocks" all 4 shocks should be matched by series.;

8 Pair Packs.;

40 Complete Assembled Unit.;



82 Use kit if listed, See Ref. C for optional Steering Stabilizer Boots.;

7 Pair Packs, Air hose kit included.;

35 Slight grinding of control arm opening is required to install product made before Aug 1988.;

80 Mounting bracket not required, install on O.E. Shock Mounts. See Ref. C for optional Steering Stabilizer Boots.;

APPLICATION GUIDE

Year	Fitment Notes	OEM#								
			Fleetline/ Gas SLX	Classic/ Ultra/ ProGuard/ Guardian	Max Control/ LTV Severe Duty/ Load Carrier/ HiJackers	Steering Dampers/ Steering Stabilizer/ Cab Shock	Fleetline/ Gas SLX	Classic/ Ultra/ ProGuard/ Guardian	Max Control/ LTV Severe Duty/ Load Carrier/ HiJackers	Steering Dampers/ Steering Stabilizer/ Cab Shock

DODGE

DODGE

VAN 1/2 TON, A / B SERIES / RAM (cont)

71-87	Single System Steering Stabilizer		⊖						6803SE ⁸⁴			
81	109.6 / 278.4(WheelBase) Exc. 7000# GVW		⊖	61523 ³⁵ 81096 ³⁵ G63359 ³⁵	58359 ³⁵	⊖	61522 ⁹ 81496 G63413	43085 ⁹
71-80	All		⊖	61523 ³⁵ 81096 ³⁵	34052 ⁸ 58359 ³⁵	⊖	61522 ⁹ 81496 G63413	43085 ⁹ 49212 ⁷
	Exc. 4000# Front Axle		⊖	G63359 ³⁵	⊖
71	with I Beam Axle		⊖					⊖				6802SE ⁸⁴

VAN 3/4 TON, A / B SERIES / RAM

81-03	All		⊖	61523 ³⁵ 81096 ³⁵ G63359 ³⁵	34052 ⁸ 58359 ³⁵	⊖	61522 ⁹ 81496 G63413	43085 ⁹ 49212 ⁷
80-87	Single System Steering Stabilizer		⊖					⊖				6803SE ⁸⁴
71-80	All		⊖	61523 ³⁵ 81096 ³⁵	34052 ⁸ 58359 ³⁵	⊖	61522 ⁹ 81496 G63413	43085 ⁹ 49212 ⁷
	Exc. 4000# Front Axle		⊖	G63359 ³⁵	⊖
78-79	Van Charger Special		⊖					⊖				6803SE ⁸⁴
71-77	Single System Steering Stabilizer		⊖					⊖				6803SE ⁸⁴
71	with I Beam Axle		⊖					⊖				6802SE ⁸⁴

VAN 1 TON, A / B SERIES / RAM

95-03	All		⊖	61523 ³⁵ 81096 ³⁵ G63359 ³⁵	34052 ⁸ 58359 ³⁵	⊖	61522 ⁹ 81496 G63413	43085 ⁹ 49212 ⁷
94	All		⊖	⊖	61522 ⁹ 81496	43085 ⁹ 49212 ⁷
	Exc. 4000# Front Axle		⊖	61523 ³⁵ 81096 ³⁵ G63359 ³⁵	34052 ⁸ 58359 ³⁵	⊖	G63413
71-93	All		⊖	⊖	61522 ⁹ 81496 G63413	43085 ⁹ 49212 ⁷
	4000# Front Axle		⊖	81834 G63360 ³⁵	⊖
	Exc. 4000# Front Axle		⊖	61523 ³⁵ 81096 ³⁵ G63359 ³⁵	34052 ⁸ 58359 ³⁵	⊖
71-87	Single System Steering Stabilizer		⊖					⊖				6803SE ⁸⁴
71	with I Beam Axle		⊖					⊖				6802SE ⁸⁴

VAN 1 TON, P SERIES

66-72	All		⊖	⊖	82065
61-64	All		⊖	⊖	82065

VAN, CB300



78-80	All		⊖	⊖	61522 ⁹ 81496 G63413	43085 ⁹ 49212 ⁷
	Exc. 4000# Front Axle		⊖	61523 ³⁵ 81096 ³⁵ G63359 ³⁵	34052 ⁸ 58359 ³⁵	⊖
74-80	4000# Front Axle		⊖	81834 G63360 ³⁵	⊖

6 It is recommended that when replacing shocks on vehicles with "quad shocks" all 4 shocks should be matched by series;
8 Pair Packs;

7 Pair Packs, Air hose kit included.;

35 Slight grinding of control arm opening is required to install product made before Aug 1988.;

APPLICATION GUIDE

Year	Fitment Notes	OEM#								
			Fleetline\ Gas SLX	Classic\ Ultra\ ProGuard\ Guardian	Max Control\ LTV Severe Duty\ Load Carrier\ HiJackers	Steering Dampers\ Steering Stabilizer\ Cab Shock	Fleetline\ Gas SLX	Classic\ Ultra\ ProGuard\ Guardian	Max Control\ LTV Severe Duty\ Load Carrier\ HiJackers	Steering Dampers\ Steering Stabilizer\ Cab Shock

DODGE

DODGE

VAN, CB300 (cont)

74-77	Exc. 4000# Front Axle		⊖	61523 ³⁵ 81096 ³⁵ G63359 ³⁵	⊖
	Up through 8300# GVW		⊖	34052 ⁸ 58359 ³⁵	⊖
77	All		⊖	⊖	61522 ⁶ 81496 G63413	43085 ⁸
	Over 8300# GVW		⊖	⊖	49212 ⁷
75-76	All		⊖	⊖	61522 ⁶ 81496 G63413	43085 ⁸ 49212 ⁷
74	All		⊖	⊖	61522 ⁶ 81496 G63413	43085 ⁸
	Over 8300# GVW		⊖	⊖	49212 ⁷

FORD

FORD

C600

80-86	Models with 3100 lb Spring and 7000 lb Axle	D7HT-18045-JA	⊖	83308	⊖
	Models with 4040, 5040 lb Springs and 7000, 9000, 12000 lb Axles	D2EF-18045-AA	⊖	83312	⊖

E-450 ECONOLINE SUPER DUTY

00-02	All		⊖	G63622	58622 77614	⊖	61646 G63623	58623
	Exc. Cutaway Chassis		⊖	⊖	77623
	Single System Steering Stabilizer		⊖	⊖	6828SE ⁸⁰

E-550 ECONOLINE SUPER DUTY

02	All		⊖	⊖	61655
	Single System Steering Stabilizer		⊖	⊖	6828SE ⁸⁰

E-550 SUPER DUTY

03	All		⊖	⊖	61655
	Single System Steering Stabilizer		⊖	⊖	6828SE ⁸⁰

ECONOLINE

00-06	All		⊖	G63622	58622	⊖	61646 G63623	58623
61-67	All		⊖	61506 81318 G63492	⊖	82007 G63299	49311 ⁷

ECONOLINE SUPER DUTY

96-99	All		⊖	77614	⊖	77623
	Single System Steering Stabilizer		⊖	⊖	6828SE ⁸⁰

ECONOLINE VAN

61-67	Van Single System Steering Stabilizer All models with factory frame bracket. Kit 143168 required to install to linkage.		⊖	⊖	6802SE ⁸⁴
-------	---	--	---	------	------	------	------	---	------	----------------------	------

6 It is recommended that when replacing shocks on vehicles with "quad shocks" all 4 shocks should be matched by series.;

8 Pair Packs.;



80 Mounting bracket not required, install on O.E. Shock Mounts. See Ref. C for optional Steering Stabilizer Boots.;

7 Pair Packs, Air hose kit included.;

35 Slight grinding of control arm opening is required to install product made before Aug 1988.;

84 Replacement damper for vehicles with the Gabriel Aftermarket mounting kit;

APPLICATION GUIDE

Year	Fitment Notes	OEM#								
			Fleetline\ Gas SLX	Classic\ Ultra\ ProGuard\ Guardian	Max Control\ LTV\ Severe Duty\ Load Carrier\ HiJackers	Steering Dampers\ Steering Stabilizer\ Cab Shock	Fleetline\ Gas SLX	Classic\ Ultra\ ProGuard\ Guardian	Max Control\ LTV\ Severe Duty\ Load Carrier\ HiJackers	Steering Dampers\ Steering Stabilizer\ Cab Shock

FORD

FORD

EXCURSION

00-05	4WD		O	O	G63809	77809	O	O	G63837	77837
	4WD; With OE Unit		O	O	6854SE ⁸⁰									
	RWD		I	O	G63614	77614	O	O	G63607	77607

F-59 COMMERCIAL STRIPPED CHASSIS

11-24	MotorHomes with Ford F59 Commercial Chassis with 24,000 lb GVW to 26,000 lb GVW	ASH-25821 ASH-1161 HU9Z-18124-A	O	O	85006	O	O
11-21	F59 Commercial Chassis with 16,000 lb or 19,500 GVW	471700009775 CU9Z-18125-A ASH-12261 ASH-24523 ASH-24589 DU94-18080-CA BU9Z-18125-A 471700007117 ASH-24474 DU94-18080-CB DU9Z-18125-A DU9Z-18125-B	O	O	O	O	85010
	F59 Commercial Chassis with 16,000 lb to 22,000 GVW	ASH-12251 CU9Z-18124-A ASH-24473 BU9Z-18124-A ASH-24522 ASH-24634 DU9Z-18124-A DU9Z-18124-B	O	O	85013	O	O
89-97	F59 Commercial Chassis with 16,000 lb or 19,500 GVW	471700009775 CU9Z-18125-A ASH-12261 ASH-24523 ASH-24589 DU94-18080-CA BU9Z-18125-A 471700007117 ASH-24474 DU94-18080-CB DU9Z-18125-A DU9Z-18125-B	O	O	O	O	85010
	F59 Commercial Chassis with 16,000 lb to 22,000 GVW	ASH-12251 CU9Z-18124-A ASH-24473 BU9Z-18124-A ASH-24522 ASH-24634 DU9Z-18124-A DU9Z-18124-B	O	O	85013	O	O

F-200

86-90	All		I	O	81490	O	O
-------	-----	--	---	---	------	-------	------	------	---	---	------	------	------	------

F-250 HD

97	4WD		O	O	61614 81821 G63455	O	O	61530 81510 G63461	77461
	4WD, Quad Suspension; Rearward of Front Axle		I	O	77414 ⁶	O	O
	RWD		I	O	61520 81490	O	O	61547 81082 G63809	77809
	RWD, Quad Suspension; Rearward of Front Axle		I	O	O	O	43167 ⁶



F-600 SUPER DUTY

20-24	All	KC3Z-3E651-C	O	O	14072	O	O
	Applications with OEM Number	PC3Z-18124-AGA PC3Z-18124-ARA PC3Z-18124-AKA	I	O	G63622	O	O

6 It is recommended that when replacing shocks on vehicles with "quad shocks" all 4 8 Pair Packs; shocks should be matched by series.;

80 Mounting bracket not required, install on O.E. Shock Mounts. See Ref. C for

APPLICATION GUIDE

Year	Fitment Notes	OEM#								
			Fleetline\ Gas SLX	Classic\ Ultra\ ProGuard\ Guardian	Max Control\ LTV Severe Duty\ Load Carrier\ HiJackers	Steering Dampers\ Steering Stabilizer\ Cab Shock	Fleetline\ Gas SLX	Classic\ Ultra\ ProGuard\ Guardian	Max Control\ LTV Severe Duty\ Load Carrier\ HiJackers	Steering Dampers\ Steering Stabilizer\ Cab Shock

FORD

FORD

F-600 SUPER DUTY (cont)

20-24	Applications with OEM Number	PC3Z-18124-SBA, PC3Z-18124-JA		G63886	77967
	4 X 2, Models with RWD and OEM number	HC3Z-18125-B, HC3Z-18125-ED, EC3Z-18125-EE, EC3Z-18125-EF, PC3Z-18125-CFA, PC3Z-18125-CEA		77987

LCF450

06-09	w/ vari-rate suspension w/ vari-rate suspension	6E7Z-18125-A			83364
-------	---	--------------	--	------	------	------	------	--	-------	------	------	------



LCF550

06-09	w/ vari-rate suspension w/ vari-rate suspension	6E7Z-18125-A			83364
-------	---	--------------	--	------	------	------	------	--	-------	------	------	------

PICKUP 3/4 TON, F-250 / SUPERDUTY

23-24	4WD	PC3Z-18124-SDA, PC3Z-18124-BBA, PC3Z-18124-BCA, PC3Z-18124-BFA, PC3Z-18124-DAA, PC3Z-18124-SAA, PC3Z-18124-DBA, PC3Z-18124-SCA		G63886	77951
	RWD	PC3Z-18124-AFA, PC3Z-18124-AEA, PC3Z-18124-AHA		G63622
		PC3Z-18124-SDA, PC3Z-18124-BBA, PC3Z-18124-BCA, PC3Z-18124-BFA, PC3Z-18124-DAA, PC3Z-18124-SAA, PC3Z-18124-DBA, PC3Z-18124-SCA		58807 77807
24	4WD			61680	14072	
		PC3Z-18125-Y, PC3Z-18125-BA, PC3Z-18125-AA, PC3Z-18125-K, PC3Z-18125-X, PC3Z-18125-DA, PC3Z-18125-S, PC3Z-18125-CA, PC3Z-18125-J		77988
	RWD	PC3Z-18125-CFA, PC3Z-18125-CCA, PC3Z-18125-CEA, PC3Z-18125-CDA		G64269
23	4WD			61680	14072		G64268	77988
	RWD			G64269
17-22	4WD			61680 G63886	77951	14072		G64268	77988
	RWD			58807 77807	G64269
	RWD, Exc. Off Road Package			G63622
12-16	RWD, w/ Off Road Package			G63886	61682
11-16	RWD			58807 77807
	RWD, Exc. Off Road Package			G63622	61713 G64010
08-16	4WD			61680 G63886	77951	14072		61682 G63888	77952
05-10	RWD			G63622	58807 77807	G64010
	RWD, Exc. Off Road Package			61713

APPLICATION GUIDE

Year	Fitment Notes	OEM#								
			Fleetline\ Gas SLX	Classic\ Ultra\ ProGuard\ Guardian	Max Control\ LTV\ Severe Duty\ Load Carrier\ HiJackers	Steering Dampers\ Steering Stabilizer\ Cab Shock	Fleetline\ Gas SLX	Classic\ Ultra\ ProGuard\ Guardian	Max Control\ LTV\ Severe Duty\ Load Carrier\ HiJackers	Steering Dampers\ Steering Stabilizer\ Cab Shock

FORD

FORD

PICKUP 3/4 TON, F-250 / SUPERDUTY (cont)

99-10	RWD, Single System Steering Stabilizer		O	6828SE ⁸⁰								
05-07	4WD		I	61680 G63886	77951	O	61682 G63888	77952
	Exc. OE Unit		O	6856SE ⁸⁶								
99-04	4WD		O	61655 G63809	58809 77809	O	61656 G63810	58810 77810
	4WD; Replacement Kit		O	6855SE ⁸²								
	Exc. OE Unit		O	6850SE ⁸⁶								
	RWD		I	G63622	58807 77807	O	61654 G63808	58808 77808
99-03	4WD; With OE Unit		O	6854SE ⁸⁰								



PICKUP 1 TON, F-350 / SUPERDUTY

23-24	4WD	PC3Z-18124-SDA, PC3Z-18124-BBA, PC3Z-18124-BCA, PC3Z-18124-BFA, PC3Z-18124-DAA, PC3Z-18124-SAA, PC3Z-18124-DBA, PC3Z-18124-SCA	I O	G63886	77951	O
	RWD	PC3Z-18124-AFA, PC3Z-18124-AEA, PC3Z-18124-AHA	I O	G63622	O
		PC3Z-18124-SDA, PC3Z-18124-BBA, PC3Z-18124-BCA, PC3Z-18124-BFA, PC3Z-18124-DAA, PC3Z-18124-SAA, PC3Z-18124-DBA, PC3Z-18124-SCA	I O	58807 77807	O
24	4WD		I O	61680	14072	O
	RWD	PC3Z-18125-Y, PC3Z-18125-BA, PC3Z-18125-AA, PC3Z-18125-K, PC3Z-18125-X, PC3Z-18125-DA, PC3Z-18125-S, PC3Z-18125-CA, PC3Z-18125-J	I O	O	G64268	77988
		PC3Z-18125-CFA, PC3Z-18125-CCA, PC3Z-18125-CEA, PC3Z-18125-CDA	I O	O	G64269
23	4WD		I O	61680	14072	O	G64268	77988
	RWD		I O	O	G64269
17-22	4WD		I O	61680 G63886	77951	14072	O	G64268	77988
	RWD		I O	G63622	77807	O	G64269
22	RWD	PC3Z-18124-SDA, PC3Z-18124-BBA, PC3Z-18124-BCA, PC3Z-18124-BFA, PC3Z-18124-DAA, PC3Z-18124-SAA, PC3Z-18124-DBA, PC3Z-18124-SCA	I O	58807	O
13-16	All		I O	61680	58807 77807	O
	4WD		I O	61680 G63886	77951	14072	O	G63888	77952
	4WD, w/ Off Road Package		I O	O	61682

80 Mounting bracket not required, install on O.E. Shock Mounts. See Ref. C for optional Steering Stabilizer Boots;;

82 Use kit if listed, See Ref. C for optional Steering Stabilizer Boots.;

APPLICATION GUIDE

Year	Fitment Notes	OEM#								
			Fleetline\ Gas SLX	Classic\ Ultra\ ProGuard\ Guardian	Max Control\ LTV Severe Duty\ Load Carrier\ HiJackers	Steering Dampers\ Steering Stabilizer\ Cab Shock	Fleetline\ Gas SLX	Classic\ Ultra\ ProGuard\ Guardian	Max Control\ LTV Severe Duty\ Load Carrier\ HiJackers	Steering Dampers\ Steering Stabilizer\ Cab Shock

FORD

FORD

PICKUP 1 TON, F-350 / SUPERDUTY (cont)

11-16	4WD			77951
	Exc. Off Road Package			G63622
	w/ Off Road Package			G63886
05-16	RWD			G63622	58807 77807	G64010
	RWD, Exc. Off Road Package			61713
11-12	All			61680	77807
08-12	4WD			61680 G63886	77951	14072	
05-12	4WD; Single Rear Wheels; Exc. Cab & Chassis			61682 G63888	77952
99-10	RWD, Single System Steering Stabilizer			6828SE ⁸⁰								
99-09	All			61680	77807
	4WD			77951
	Exc. Off Road Package			G63622
	w/ Off Road Package			G63886
05-07	4WD			61680 G63886	77951
99-04	4WD			61655 G63809	58809 77809	61656 G63810	58810 77810
	4WD; Replacement Kit			6855SE ⁸²								
	Exc. OE Unit			6850SE ⁸⁰								
	RWD			G63622	58807 77807	61654 G63808	58808 77808
99-03	4WD; With OE Unit			6854SE ⁸⁰								
92-97	RWD, Dual System Steering Stabilizer All models with factory frame bracket. Kit 143168 required to install to linkage.			6802SE ⁸⁴								
	RWD, Single System Steering Stabilizer			6828SE ⁸⁰								
86-97	4WD			61614 81821 G63455	77455
	4WD, Dual Rear Wheels			61530 81510 G63461	77461
	4WD, Exc. Dual Rear Wheels			G63456
80-97	RWD			61520 ⁶ 81490
	RWD, Dual Rear Wheels			61554 81710 G63409
	RWD, Exc. Dual Rear Wheels			61547 81082 G63809	77809
	RWD, Exc. Dual Rear Wheels; Quad Suspension; Rearward of Front Axle			43167 ⁸
	RWD, Quad Suspension; Rearward of Front Axle			77414 ⁶

6 It is recommended that when replacing shocks on vehicles with "quad shocks" all 4 shocks should be matched by series;

80 Mounting bracket not required, install on O.E. Shock Mounts. See Ref. C for optional Steering Stabilizer Boots;;



84 Replacement damper for vehicles with the Gabriel Aftermarket mounting kit;

8 Pair Packs.;

82 Use kit if listed, See Ref. C for optional Steering Stabilizer Boots.;

86 Exc. OE Unit;

APPLICATION GUIDE

Year	Fitment Notes	OEM#								
			Fleetline/ Gas SLX	Classic/ Ultra/ ProGuard/ Guardian	Max Control/ LTV Severe Duty/ Load Carrier/ HiJackers	Steering Dampers/ Steering Stabilizer/ Cab Shock	Fleetline/ Gas SLX	Classic/ Ultra/ ProGuard/ Guardian	Max Control/ LTV Severe Duty/ Load Carrier/ HiJackers	Steering Dampers/ Steering Stabilizer/ Cab Shock

FORD

FORD



PICKUP 1 TON, F-350 / SUPERDUTY (cont)

89-91	RWD, Single System Steering Stabilizer All models with factory frame bracket. Kit 143168 required to install to linkage.		O O	6802SE ⁸⁴							
82-88	RWD; w/o Anti-Sway Bar		O O	6802SE ⁸⁴							
82-85	4WD, Clevis Type Lower Front Mount; Exc. Dual Rear Wheels or Lift Kit		O O	61530 81510 G63461	77461
80-81	4WD		O O	61546 ⁶ G63410	61530 81510 G63461	77461
79-81	RWD, Dual System Steering Stabilizer All models with factory frame bracket. Kit 143168 required to install to linkage.		O O	6802SE ⁸⁴							
75-79	RWD, RWD, 4WD Quad Suspension Rearward of Front Axle, Non Quad Suspension		O O	G63386
	RWD, Cab & Chassis		O O	43099 ⁸ 49173 ⁷
	RWD, Extended Cab Pickup		O O	G63350	43099 ⁸ 49173 ⁷
	RWD, Standard Cab Pickup		O O	61519 81484 G63377	43058 ⁸
	RWD; Supercab		O O	81242
73-79	RWD, Quad Suspension Rearward of Front Axle		O O	34058 ⁸
	RWD; Standard Cab Pickup		O O	49127 ⁷
67-79	RWD; Extended Cab		O O	61518
79	4WD		O O	G63387	49178 ⁷
	RWD; Quad Suspension Rearward of Front Axle		O O	61521 ⁶ 81394 ⁶
75-78	Dual System Steering Stabilizer All models with factory frame bracket. Kit 143168 required to install to linkage.		O O	6802SE ⁸⁴							
68-78	RWD		O O	81394
	RWD; Quad Suspension Rearward of Front Axle		O O	61521 ⁶
75-77	Manual Steering Single System Steering Stabilizer		O O	6803SE ⁸⁴							
73-74	RWD; Supercab		O O	G63377
	RWD; Exc. Supercab		O O	61519 81484
	RWD; Supercab		O O	43058 ⁸
67-74	RWD, 4WD Quad Suspension Rearward of Front Axle, Non Quad Suspension		O O	G63386
65-74	w/ Twin I Beam Axle		O O	6802SE ⁸⁴							
60-74	Single System Steering Stabilizer		O O	6803SE ⁸⁴							
74	RWD, Extended Cab & Chassis Cab		O O	49173 ⁷
	RWD, Supercab		O O	G63350	43099 ⁸
67-73	RWD, Supercab		O O	G63350
67	RWD; Quad Suspension Rearward of Front Axle		O O	61521 ⁶ 81394 ⁶

6 It is recommended that when replacing shocks on vehicles with "quad shocks" all 4 7 Pair Packs, Air hose kit included.; shocks should be matched by series.;

84 Replacement damper for vehicles with the Gabriel Aftermarket mounting kit;

APPLICATION GUIDE

Year	Fitment Notes	OEM#								
			Fleetline\ Gas SLX	Classic\ Ultra\ ProGuard\ Guardian	Max Control\ LTV Severe Duty\ Load Carrier\ HiJackers	Steering Dampers\ Steering Stabilizer\ Cab Shock	Fleetline\ Gas SLX	Classic\ Ultra\ ProGuard\ Guardian	Max Control\ LTV Severe Duty\ Load Carrier\ HiJackers	Steering Dampers\ Steering Stabilizer\ Cab Shock

FORD

FORD

PICKUP 1 TON, F-350 / SUPERDUTY (cont)

65-66	All		OIO	81147	OIO	61500 G63405	43048 ⁸
61-64	All		OIO	OIO	61500 81147 G63405	43048 ⁸
60-64	Single System Steering Stabilizer w/ I Beam Axle All models with factory frame bracket. Kit 143168 required to install to linkage.		OIO	6802SE ⁸⁴								
60	All		OIO	OIO	81270
53-55	All		OIO	OIO	81676

PICKUP P100

65-67	Single System Steering Stabilizer All models with factory frame bracket. Kit 143168 required to install to linkage.		OIO	6802SE ⁸⁴								
-------	---	--	-----	----------------------	--	--	--	--	--	--	--	--

PICKUP P350

76	Up through 8000# GVW		OIO	61500 G63405	77907	OIO
68-75	Up through 8000# GVW		OIO	61500 81147 G63405	77907	OIO
68-73	Single System Steering Stabilizer All models with factory frame bracket. Kit 143168 required to install to linkage.		OIO	6802SE ⁸⁴								



PICKUP P400

75-76	Up through 8000# GVW		OIO	61500 81147 G63405	77907	OIO
-------	----------------------	--	-----	------	--------------------------	-------	------	-----	------	------	------	------

PICKUP, F-450 SUPERDUTY

17-24	4 X 4		OIO	14072	OIO
24	All	PC3Z-18124-CGA, PC3Z-18124-HA, PC3Z-18124-ARA, PC3Z-18124-SGA	OIO	77967	OIO
	4 X 4, Models with 4WD and OEM number	ASH-85927 LC3Z-18125-W ASH-866127 ASH-866139 HC3Z-18125-EP HC3Z-18125-X PC3Z-18125-F ASH-85789	OIO	OIO	77986
	RWD, Models with RWD and OEM number	HC3Z-18125-ED HC3Z-18125-EE HC3Z-18125-B ASH-85857	OIO	OIO	77987
17-23	Models with 4WD and OEM number	ASH-85927 LC3Z-18125-W ASH-866127 ASH-866139 LC3Z-18125-J HC3Z-18125-EP HC3Z-18125-X ASH-85789	OIO	OIO	77986
	Models with RWD and OEM number	ASH-25770 HC3Z-18125-ED HC3Z-18125-EE HC3Z-18125-B ASH-85857 ASH-85856	OIO	OIO	77987
13-23	All		OIO	77967	OIO
13-16	4 X 2		OIO	OIO	77968
	4 X 4		OIO	14072	OIO	77969

APPLICATION GUIDE

Year	Fitment Notes	OEM#								
			Fleetline\ Gas SLX	Classic\ Ultra\ ProGuard\ Guardian	Max Control\ LTV\ Severe Duty\ Load Carrier\ HiJackers	Steering Dampers\ Steering Stabilizer\ Cab Shock	Fleetline\ Gas SLX	Classic\ Ultra\ ProGuard\ Guardian	Max Control\ LTV\ Severe Duty\ Load Carrier\ HiJackers	Steering Dampers\ Steering Stabilizer\ Cab Shock

FORD

FORD



PICKUP, F-450 SUPERDUTY (cont)

09-12	All		OO	58944
08-12	4 X 4		OO	14072
07-08	All		O	G63969	58944 77967
05-07	4 X 2		OO	77968
	4 X 4		OO	77969
99-07	Models with single or dual rear wheels with 165" or 201" wheel base	AT-611 F81A-18080-DCA AT-610 ASH-23488 ASH-247 F81Z-18125-DC ASH-23486	OO	G63461
05-06	All		OO	G63969	77967
99-04	All		OO	61655 G63809	58809 77809	77461
	4 X 4, Single System Steering Stabilizer		OO	6854SE ⁸⁰							
97	All		OO	G63692	61554 G63409
	Quad Suspension; Rearward of Front Axle		OO	43167 ⁸

PICKUP, F-550 SUPERDUTY

17-24	4 X 4		OO	14072
24	All	PC3Z-18124-CGA, PC3Z-18124-HA, PC3Z-18124-ARA, PC3Z-18124-SGA	O	77967
	4 X 4, Models with 4WD and OEM number	ASH-85927 LC3Z-18125-W ASH-866127 ASH-866139 HC3Z-18125-EP HC3Z-18125-X PC3Z-18125-F ASH-85789	OO	77986
	RWD, Models with RWD and OEM number	ASH-25770 HC3Z-18125-ED HC3Z-18125-EE HC3Z-18125-B ASH-85857 ASH-85856	OO	77987
17-23	Models with 4WD and OEM number	ASH-85927 LC3Z-18125-W ASH-866127 ASH-866139 LC3Z-18125-J HC3Z-18125-EP HC3Z-18125-X ASH-85789	OO	77986
	Models with RWD and OEM number	ASH-25770 HC3Z-18125-ED HC3Z-18125-EE HC3Z-18125-B ASH-85857 ASH-85856	OO	77987
13-23	All		OO	77967
13-16	4 X 2		OO	77968
	4 X 4		OO	14072	77969
10-12	All		OO	58944	
08-12	4 X 4		OO	14072
05-07	All		OO	G63969	77967

APPLICATION GUIDE

Year	Fitment Notes	OEM#								
			Fleetline\ Gas SLX	Classic\ Ultra\ ProGuard\ Guardian	Max Control\ LTV Severe Duty\ Load Carrier\ HiJackers	Steering Dampers\ Steering Stabilizer\ Cab Shock	Fleetline\ Gas SLX	Classic\ Ultra\ ProGuard\ Guardian	Max Control\ LTV Severe Duty\ Load Carrier\ HiJackers	Steering Dampers\ Steering Stabilizer\ Cab Shock

FORD

FORD

PICKUP, F-550 SUPERDUTY (cont)

05-07	4 X 2	
	4 X 4	
99-07	Models with single or dual rear wheels with 165" or 201" wheel base	AT-611 F81A-18080-DCA AT-610 ASH-23488 ASH-247 F81Z-18125-DC ASH-23486	G63461
99-04	All		...	61655 G63809	58809 77809	77461	...
	4 X 4, Single System Steering Stabilizer		...	6854SE ⁸⁰								

TRANSIT-150

23-25	All		G64177
15-22	All		...	G57816 ⁴⁰	G64177

TRANSIT-250

23-25	All		G64177
15-22	All		...	G57816 ⁴⁰	G64177

TRANSIT-350

23-25	All		G64177
15-22	All		...	G57816 ⁴⁰	G64177

TRANSIT-350 HD

25-26	All	FK3Z-18125-C	G64177
-------	-----	--------------	-----	-----	-----	-----	-----	-----	--------	-----	-----	-----

VAN 1/2 TON, ECONOLINE / CLUB WAGON

03-14	All		...	61591	58929 77608
02	All		...	61591	77608
75-91	All		...	81914 G63716	77716

VAN 3/4 TON, ECONOLINE / CLUB WAGON / SUPERDUTY

03-14	All		...	81744 ⁴⁸ G63622	34076 ⁸ 58622 77614	61646 81828 G63623	49178 ⁷ 58623 77623
96-04	Single System Steering Stabilizer		...	6828SE ⁸⁰								
92-02	All		...	61591 81744 ⁴⁸ G63622	34076 ⁸ 58622 77614	61646 81828 G63623	49178 ⁷ 58623 77623
76-91	All		...	61521 81394	G63387	49178 ⁷
75-91	RWD, 4WD Quad Suspension Rearward of Front Axle, Non Quad Suspension		...	G63386
	RWD, Quad Suspension Rearward of Front Axle		34058 ⁸
74-79	QuadraVan Special		...	6803SE ⁸⁴								
75	All		...	61521 ⁶ 81394	G63387	49178 ⁷

6 It is recommended that when replacing shocks on vehicles with "quad shocks" all 4 shocks should be matched by series.;

8 Pair Packs.;

48 Installation Hardware Included.;



84 Replacement damper for vehicles with the Gabriel Aftermarket mounting kit.;

7 Pair Packs, Air hose kit included.;

40 Complete Assembled Unit.;

80 Mounting bracket not required, install on O.E. Shock Mounts. See Ref. C for optional Steering Stabilizer Boots.;

APPLICATION GUIDE

Year	Fitment Notes	OEM#								
			Fleetline/ Gas SLX	Classic/ Ultra/ ProGuard/ Guardian	Max Control/ LTV Severe Duty/ Load Carrier/ HiJackers	Steering Dampers/ Steering Stabilizer/ Cab Shock	Fleetline/ Gas SLX	Classic/ Ultra/ ProGuard/ Guardian	Max Control/ LTV Severe Duty/ Load Carrier/ HiJackers	Steering Dampers/ Steering Stabilizer/ Cab Shock

FORD

FORD

VAN 3/4 TON, ECONOLINE / CLUB WAGON / SUPERDUTY (cont)

69-74	All			○		82012					○		61519 81484 G63377	43058 ⁸ 49127 ⁷	
	with Twin I-Beam Axle			○							○				

VAN 1 TON, ECONOLINE / CLUB WAGON / SUPERDUTY

25-26	All	8C2Z-18124-D		○		G63622	58622 77614				○		61646 G63623	58623 77623	
21-24	Single System Steering Stabilizer			○							○				6828SE ⁸⁰
24	All	8C2Z18124D		○		G63622					○				
		8C2Z18125D		○							○		G63623		
				○		81744 ⁴⁸	58622 77614				○		61646 81828	49178 ⁷ 58623 77623	
21-23	All			○		81744 ⁴⁸ G63622	58622 77614				○		61646 81828 G63623	49178 ⁷ 58623 77623	
12-19	All			○		81744 ⁴⁸ G63622	34076 ⁸ 58622 77614				○		61646 81828 G63623	49178 ⁷ 58623	
	Exc. Cutaway Chassis			○			77614				○		81828	58623 77623	
92-19	Single System Steering Stabilizer			○							○				6828SE ⁸⁰
10-11	All			○		61591 81744 ⁴⁸ G63622	34076 ⁸ 58622 77614				○		61646 81828 G63623	49178 ⁷ 58623	
08-11	Exc. Cutaway Chassis			○			58622 77614				○		61646 81828 G63623	58623 77623	
09	All			○		61591 81744 ⁴⁸ G63622	34076 ⁸ 58622 77614				○		61646 G63623	49178 ⁷ 58623	
07-08	All			○		61591 81744 ⁴⁸ G63622	34076 ⁸ 58622 77614				○		61646 G63623	49178 ⁷ 58623 77623	
	Cutaway Chassis			○			58622				○			58623	
07	Exc. Cutaway Chassis			○		G63622	58622 77614				○		61646 81828 G63623	49178 ⁷ 58623 77623	
04-06	Exc. Cutaway Chassis			○			58622				○		61646 81828 G63623	58623 77623	
06	All			○		61591 81744 ⁴⁸ G63622	34076 ⁸ 58622 77614				○		61646 G63623	49178 ⁷ 58623	
04-05	All			○		61591 81744 ⁴⁸ G63622	34076 ⁸ 58622 77614				○		61646 81828 G63623	49178 ⁷ 58623	
92-05	Cutaway Chassis			○		G63622	58622 77614				○		G63623	58623 77623	
99-03	All			○		61591 81744 ⁴⁸ G63622	34076 ⁸ 58622 77614				○		61646 81828 G63623	49178 ⁷ 58623 77623	
03	Exc. Cutaway Chassis			○							○			77623	
92-98	All			○		61591 81744 ⁴⁸	34076 ⁸				○		61646 81828	49178 ⁷	
78-91	All			○		61521 81394					○			49178 ⁷	
77-91	RWD, Quad Suspension Rearward of Front Axle			○			34058 ⁸				○				
75-91	Cutaway Chassis			○							○		G63387		

7 Pair Packs, Air hose kit included.;



48 Installation Hardware Included;

84 Replacement damper for vehicles with the Gabriel Aftermarket mounting kit;

8 Pair Packs.;

80 Mounting bracket not required, install on O.E. Shock Mounts. See Ref. C for optional Steering Stabilizer Boots.;

APPLICATION GUIDE

Year	Fitment Notes	OEM#								
			Fleetline\ Gas SLX	Classic\ Ultra\ ProGuard\ Guardian	Max Control\ LTV Severe Duty\ Load Carrier\ HiJackers	Steering Dampers\ Steering Stabilizer\ Cab Shock	Fleetline\ Gas SLX	Classic\ Ultra\ ProGuard\ Guardian	Max Control\ LTV Severe Duty\ Load Carrier\ HiJackers	Steering Dampers\ Steering Stabilizer\ Cab Shock

FORD

FORD

VAN 1 TON, ECONOLINE / CLUB WAGON / SUPERDUTY (cont)

75-91	Cutaway Chassis RWD, 4WD Quad Suspension Rearward of Front Axle, Non Quad Suspension				G63386				
	Exc. Cutaway Chassis								49178 ⁷
	RWD, Exc. Cutaway Chassis; Quad Suspension Rearward of Front Axle								34058 ⁸
77	All				61521 61521 ⁶ 81394				49178 ⁷
	Exc. Cutaway Chassis RWD, 4WD Quad Suspension Rearward of Front Axle, Non Quad Suspension				81394				
76	All				61521 81394				
75	All				61521 ⁶ 81394				
69-74	All				82012				61519 81484 G63377

FREIGHTLINER

FREIGHTLINER

FL50

95-05	Day Cab Suspensions with O.E.M. Number	18-32999-001 18-60295-000 18-30378-000							83006
	Models with 10,000 to 18,000 lb Suspension	6803230300 471700003009 10-13759-000 GBL665538			85006				
	Models with 15,000 lb Rear Suspension	6803260000 GBL654725							83120
	Models with 6000 to 9000 lb Front axle	6803230200			85043				
	Models with FAS II (40,000 lb) Rear Air Suspension	16-15817-000 16-13957-000							85724 89443

M2 100

02-10	Models with FAS II (40,000 lb) Rear Air Suspension	16-15817-000 16-18708-000 481700006848 471700002809 SDA471700002809							85724 89443
	Models with Freightliner Low Profile Rear Air Suspension (18,000 to 40,000 lb)	16-14259-000 471700002992 16-18706-000							85331
	Models with Freightliner TuffTrac Rear Air Suspension	481700125969 16-15770-000							85956
	Models with Hendrickson HMX 400/460 Haulmax with 16.5" Saddle	60680-004L 60680-004 H60680-004							83143
	Models with Hendrickson HMX 400/460 Haulmax with 17.5" & 18.5" Saddle	60680-005L HDR60680-005 60680-005							83142
	Models with Rear 10000 lb - 15000 lb Low Profile AirLiner	16-18711-000 16-16577-000 471700002996							85335
	Models with Rear 52" Spring ,10000 lb - 15000 lb	16-16486-000 16-18710-000 471700002995							83134
	Models with Rear 52" Spring ,18000 lb - 23000 lb	471700002994 16-16442-000 16-18709-000							83134
	Models with Rear 60" Spring ,18000 lb - 23000 lb	16-15765-000 471700002993 16-18707-000							85921

6 It is recommended that when replacing shocks on vehicles with "quad shocks" all 4 shocks 7 Pair Packs, Air hose kit included.; should be matched by series.;
8 Pair Packs.;

APPLICATION GUIDE

Year	Fitment Notes	OEM#								
			Fleetline/ Gas SLX	Classic/ Ultra/ ProGuard/ Guardian	Max Control/ LTV Severe Duty/ Load Carrier/ HiJackers	Steering Dampers/ Steering Stabilizer/ Cab Shock	Fleetline/ Gas SLX	Classic/ Ultra/ ProGuard/ Guardian	Max Control/ LTV Severe Duty/ Load Carrier/ HiJackers	Steering Dampers/ Steering Stabilizer/ Cab Shock

FREIGHTLINER

FREIGHTLINER

MT45

98-23	Step Van Models with O.E.M. Number	16-20628-000 471700003011 16-22004-000 471700011302 16-19138-000	OO	85058	
	Walkin Step Van Models (18 Foot) with O.E.M. Number	16-20552-000 16-16542-000 16-15064-000 471700010991 16-15436-000	OO	OT	83154
99-20	MT45 Step Van - w/35" Front Spring	16-15473-000 16-15474-000	OO	83157	
	MT45 Step Van - w/38" Front Spring	16-15475-000	OO	83164	
98-20	Models with O.E.M. Number	16-15394-000	OO	OT	83120

MT55

	MT55 Models w/8000 lb. flat leaf front suspension	16-17684-000 16-15676-000	OO	85058	
	MT55 Step Van with O.E.M. Number To 2020	16-16542-000 16-15436-000	OO	OT	83154
99-24	Models with Freightliner Low Profile Rear Air Suspension	16-18706-000	OO	OO	85331
	MT55 Chassis with O.E.M. Number	16-17759-000 47170000447 16-20632-000	OO	85919
99-20	MT55 Step Van - w/35" Front Spring	16-15473-000 16-15474-000	OO	83157	
	MT55 Step Van - w/38" Front Spring	16-15475-000	OO	83164	
99-11	Models with O.E.M. Number	16-16262-000 16-15934-000 16-15705-000	OO	OT	83120

SPRINTER 2500

07-18	All			G57802 ⁴⁰	
02-06	All			G56778	OO	G63918

SPRINTER 3500

19-20	All			OO	G64089
07-18	All			G57802 ⁴⁰	OO	G64089

GMC

GMC



C3500HD

01-02	All			OO	61543
91-02	Exc. I Beam Front Axle			OO	43163 ⁸
	Exc. I Beam Front Axle			OO	58488
91-00	Solid Front Axle			OO	61543

C4500 TOPKICK

03-09	C Chassis - Conventional Cab with 15000, 19000, 21000 lb Multileaf Springs	15174902 88982686 22064232			85071
	C Chassis - Conventional Cab with 19000, 21000, 23000 lb Taperleaf Springs (EXC Low Profile Vehicle)	22064233			83136

APPLICATION GUIDE

Year	Fitment Notes	OEM#								
			Fleetline\ Gas SLX	Classic\ Ultra\ ProGuard\ Guardian	Max Control\ LTV Severe Duty\ Load Carrier\ HiJackers	Steering Dampers\ Steering Stabilizer\ Cab Shock	Fleetline\ Gas SLX	Classic\ Ultra\ ProGuard\ Guardian	Max Control\ LTV Severe Duty\ Load Carrier\ HiJackers	Steering Dampers\ Steering Stabilizer\ Cab Shock

GMC

GMC

C4500 TOPKICK (cont)

03-09	C Chassis - Conventional Cab with Front Shock with O.E.M. Number	88982682 15588554 15887728 19152843 22064230 15123676		83136
	Models with Link Cabmate Model GMT560	1201-1043 1202-1043		83025
	Truck Cabs with Link Cabmate Model GMC104TK	1201-0054 1202-0054		83021
90-02	C Chassis - Conventional Cab with 15000, 19000, 21000 lb Multileaf Springs	15174902 88982686 22064232		85071
	C Chassis - Conventional Cab with 19000, 21000, 23000 lb Taperleaf Springs (EXC Low Profile Vehicle)	22064233		83136
	C Chassis - Conventional Cab with Front Shock with O.E.M. Number	88982682 15588554 15887728 19152843 22064230 15123676		83136



C5500 TOPKICK

03-09	C Chassis - Conventional Cab with 15000, 19000, 21000 lb Multileaf Springs	15174902 88982686 22064232		85071
	C Chassis - Conventional Cab with 19000, 21000, 23000 lb Taperleaf Springs (EXC Low Profile Vehicle)	22064233		83136
	C Chassis - Conventional Cab with Front Shock with O.E.M. Number	88982682 15588554 15887728 19152843 22064230 15123676		83136
	Models with Link Cabmate Model GMT560	1201-1043 1202-1043		83025
	Truck Cabs with Link Cabmate Model GMC104TK	1201-0054 1202-0054		83021
90-02	C Chassis - Conventional Cab with 15000, 19000, 21000 lb Multileaf Springs	15174902 88982686 22064232		85071
	C Chassis - Conventional Cab with 19000, 21000, 23000 lb Taperleaf Springs (EXC Low Profile Vehicle)	22064233		83136
	C Chassis - Conventional Cab with Front Shock with O.E.M. Number	88982682 15588554 15887728 19152843 22064230 15123676		83136

PICKUP 3/4 TON, C25 / C2500

88-00	All			61544 81668 G63489	34073 ⁸ 58489 77489	61543 81667 G63488	43163 ⁸ 49218 ⁷ 58488 77488
85-86	Crew Cab Pickup			G63366
83-86	All			81039	81164
	Cab & Chassis			61524 G63349	43111 ⁸ 49155 ⁷
	Exc. Extended Cab			61525 G63355	34036 ⁸
	Standard Cab Pickup			61524 G63349	43111 ⁸ 49155 ⁷

APPLICATION GUIDE

Year	Fitment Notes	OEM#								
			Fleetline/ Gas SLX	Classic/ Ultra/ ProGuard/ Guardian	Max Control/ LTV Severe Duty/ Load Carrier/ HiJackers	Steering Dampers/ Steering Stabilizer/ Cab Shock	Fleetline/ Gas SLX	Classic/ Ultra/ ProGuard/ Guardian	Max Control/ LTV Severe Duty/ Load Carrier/ HiJackers	Steering Dampers/ Steering Stabilizer/ Cab Shock

GMC

GMC

PICKUP 3/4 TON, C25 / C2500 (cont)

67-86	Single System Steering Stabilizer All models with factory frame bracket. Kit 143168 required to install to linkage.		OO	6802SE ⁸⁴								
73-83	Crew Cab Pickup		OO	OO	G63366
79-82	Cab & Chassis		OO	OO	61524 81164 G63349	43111 ⁸ 49155 ⁷
	Exc. Extended Cab		OO	61525 81039 G63355	34036 ⁶	OO
	Standard Cab Pickup		OO	OO	61524 81164 G63349	43111 ⁸ 49155 ⁷
75-78	Cab & Chassis		OO	OO	81164	49155 ⁷
	Exc. Extended Cab		OO	61525 81039 G63355	34036 ⁶	OO	61524 G63349	43111 ⁸
	Standard Cab Pickup		OO	OO	81164	49155 ⁷
73-74	All		OO	61525 81039 G63355	34036 ⁶	OO	43111 ⁸ 49155 ⁷
	Exc. Crew Cab & Bonus Cab		OO	OO	61524 G63349
67-72	Coil(RearSpringType)		OO	OO	82003	49107 ⁷
72	All		OO	61525 81039 G63355	34036 ⁶	OO
	Leaf(RearSpringType)		OO	OO	G63306	49162 ⁷
71	All		OO	61525 81039 G63355	34036 ⁶	OO	G63306
	Leaf(RearSpringType)		OO	OO	49162 ⁷
67-70	All		OO	61525 81039 G63355	34036 ⁶	OO
	Leaf(RearSpringType)		OO	OO	G63306	49162 ⁷

PICKUP 3/4 TON, K25 / K2500

99-00	9200# GVW with OE Unit - 15059138 15155638		OO	6853SE ⁸²								
88-00	All		OO	61542 81726 G63609	58609 77609	OO	61543 81667 G63488	43163 ⁸ 49218 ⁷ 58488 77488
81-86	Quad Suspension Long Shock; Exc. Lift Kit		OO	61522 ⁶ 81496 ⁶	OO
73-86	All		OO	14017	OO
	Exc. Lift Kit		OO	OO	61524 81164 G63349	43111 ⁸
	Exc. Quad Suspension and Lift Kit		OO	61516 81113 ⁶ G63347	OO	49155 ⁷
	Single System Steering Stabilizer		OO	6804SE ⁸⁰								
67-86	Dual System Steering Stabilizer All models with factory frame bracket. Kit 143168 required to install to linkage.		OO	6802SE ⁸⁴								



6 It is recommended that when replacing shocks on vehicles with "quad shocks" all 4 shocks should be matched by series.;
8 Pair Packs.;

7 Pair Packs, Air hose kit included.;;
80 Mounting bracket not required, install on O.E. Shock Mounts. See Ref. C for optional Steering Stabilizer Boots.;;

82 Use kit if listed, See Ref. C for optional Steering Stabilizer Boots.;

84 Replacement damper for vehicles with the Gabriel Aftermarket mounting kit;

APPLICATION GUIDE

Year	Fitment Notes	OEM#								
			Fleetline\ Gas SLX	Classic\ Ultra\ ProGuard\ Guardian	Max Control\ LTV Severe Duty\ Load Carrier\ HiJackers	Steering Dampers\ Steering Stabilizer\ Cab Shock	Fleetline\ Gas SLX	Classic\ Ultra\ ProGuard\ Guardian	Max Control\ LTV Severe Duty\ Load Carrier\ HiJackers	Steering Dampers\ Steering Stabilizer\ Cab Shock

GMC

GMC

PICKUP 3/4 TON, K25 / K2500 (cont)

69-72	Exc. Quad Suspension and Lift Kit		O	O	O	O	O	O	O	O	O	O	O
67-72	Single System Steering Stabilizer		O										6803SE ⁸⁴

PICKUP 3/4 TON, R2500

87-89	Single System Steering Stabilizer All models with factory frame bracket. Kit 143168 required to install to linkage.		O	O	6802SE ⁸⁴										
	Crew Cab Pickup												G63366		
	Exc. Crew Cab & Bonus Cab		O										61524 81039 G63355	34036 ⁸	

PICKUP 3/4 TON, V2500

87	All		O	O	O	O	O	O	O	O	O	O	O	O	O	
	AN49 All models with factory frame bracket. Kit 143168 required to install to linkage.		O													6802SE ⁸⁴
	Exc. Lift Kit		O													61524 81164 G63349
	Quad Suspension Long Shock; Exc. Lift Kit		O													61522 ⁶ 81496 ⁶
	Quad Suspension Short Shock; Exc. Lift Kit		O													61516 81113 ⁶
	Single System Steering Stabilizer		O													6804SE ⁸⁰

PICKUP 1 TON, C35/3500

99-00	Exc. HD Straight Front Axle		O	O	O	O	O	O	O	O	O	O	O	O	O	O	
92-00	All		O														34073 ⁸
	Exc. HD Straight Front Axle		O														81668
	Crew Cab Pickup Exc. HD Straight Front Axle		O														61544 G63489
91-00	Extended Cab Pickup Exc. HD Straight Front Axle		O														58489 77489
	Standard Cab Pickup Exc. HD Straight Front Axle		O														58489 77489
00	Exc. I Beam Front Axle		O														61543
91-99	Exc. I Beam Front Axle		O														43163 ⁸
92-98	Cab & Chassis Exc. HD Straight Front Axle		O														58488
88-91	Cab & Chassis		O														49218 ⁷
	Cab & Chassis Exc. I Beam Front Axle		O														61543
91	All		O														77488
	Exc. HD Straight Front Axle		O														49218 ⁷
	Cab & Chassis Exc. HD Solid Front Axle		O														G63366
89-90	Extended Cab Pickup Exc. HD Straight Front Axle		O														81667 G63488
88-90	Exc. HD Straight Front Axle		O														43163 ⁸ 77488
	Cab & Chassis Exc. HD Solid Front Axle		O														61543

6 It is recommended that when replacing shocks on vehicles with "quad shocks" all 4 shocks should be matched by series.;



8 Pair Packs.;

84 Replacement damper for vehicles with the Gabriel Aftermarket mounting kit;

7 Pair Packs, Air hose kit included.;

80 Mounting bracket not required, install on O.E. Shock Mounts. See Ref. C for optional Steering Stabilizer Boots.;

APPLICATION GUIDE

Year	Fitment Notes	OEM#								
			Fleetline/ Gas SLX	Classic/ Ultra/ ProGuard/ Guardian	Max Control/ LTV Severe Duty/ Load Carrier/ HiJackers	Steering Dampers/ Steering Stabilizer/ Cab Shock	Fleetline/ Gas SLX	Classic/ Ultra/ ProGuard/ Guardian	Max Control/ LTV Severe Duty/ Load Carrier/ HiJackers	Steering Dampers/ Steering Stabilizer/ Cab Shock

GMC

GMC

PICKUP 1 TON, C35/3500 (cont)

88-90	Exc. I Beam Front Axle		58488	...
	Standard Cab Pickup Exc. HD Straight Front Axle		...	61544 G63489	58489 77489	81667 G63488	43163 ⁸ 77488
88	Extended Cab Pickup Exc. HD Straight Front Axle		...	61544 G63489	58489 77489	G63488	43163 ⁸ 77488
80-86	All		...	81039
75-86	Crew Cab Pickup Single System Steering Stabilizer All models with factory frame bracket. Kit 143168 required to install to linkage.		...	6802SE ⁸⁴						
73-78	All		...	61525 81039 G63355	34036 ⁶	G63366	...
72-74	Single System Steering Stabilizer All models with factory frame bracket. Kit 143168 required to install to linkage.		...	6802SE ⁸⁴						
67-72	All		...	61525 81039 G63355	34036 ⁶
	Exc. 11,000# Rear Axle		G63306	49162 ⁷

PICKUP 1 TON, K35 / K3500

88-00	All		...	61542 81726 G63609	58609 77609	61543 81667 G63488	43163 ⁸ 49218 ⁷ 58488 77488
77-86	All		...	G63411	...	14017	61642 81921 G63675	58412 77412
73-74	All		14017

PICKUP 1 TON, R3500

87-91	All		...	61525 81039 G63355	34036 ⁶	G63366	...
-------	-----	--	-----	--------------------------	--------------------	-----	-----	-----	--------	-----

PICKUP 1 TON, V3000 / V3500

87-91	All		...	G63411	...	14017	61642 81921 G63675	58412 77412
87-88	Quad Suspension Long Shock; Exc. Lift Kit		...	81496 ⁶

PICKUP 2500 SERIES

66	All		...	61525 81039 G63355
61-62	All		...	82035

SAVANA 4500

10-20	All		...	61685 G63895	61687 G63897	77638
-------	-----	--	-----	-----------------	-----	-----	-----	-----	-----------------	-------

SIERRA 2500

99-04	All		58817	61642 81921 G63675	58412 77412
	4WD		...	61663 81925 G63817	77817
	4WD; Up through 8600# GVW; Exc. OE Steering Stabilizer		...	6853SE ⁸²						

6 It is recommended that when replacing shocks on vehicles with "quad shocks" all 4 shocks should be matched by series.;

7 Pair Packs, Air hose kit included.;

8 Pair Packs.;

82 Use kit if listed, See Ref. C for optional Steering Stabilizer Boots.;

APPLICATION GUIDE

Year	Fitment Notes	OEM#								
			Fleetline\ Gas SLX	Classic\ Ultra\ ProGuard\ Guardian	Max Control\ LTV Severe Duty\ Load Carrier\ HiJackers	Steering Dampers\ Steering Stabilizer\ Cab Shock	Fleetline\ Gas SLX	Classic\ Ultra\ ProGuard\ Guardian	Max Control\ LTV Severe Duty\ Load Carrier\ HiJackers	Steering Dampers\ Steering Stabilizer\ Cab Shock

GMC

GMC

SIERRA 2500 (cont)

99-04	RWD, Exc. Electronic Adjustable Suspension				61641 81920 G63783	77783					
-------	--	--	--	--	--------------------------	-------	--	--	--	--	--

SIERRA 2500 HD

11-24	All				G64148						
05-10	All					58817					
	4WD				61663 G63817	77817					
01-09	9200# GVW with OE Unit - 15059138 15155638			6853SE ⁸²							
01-04	All				61663 G63817	58817					
	4WD					77817					
	RWD				81920						

SIERRA 2500 HD CLASSIC

07	All										
	4WD										

SIERRA 3500

01-06	All				61663 G63817	58817 77817					
-------	-----	--	--	--	-----------------	----------------	--	--	--	--	--

SIERRA 3500 CLASSIC

07	All				61663	58817					
----	-----	--	--	--	-------	-------	--	--	--	--	--

SIERRA 3500 HD

11-24	All				G64148						
07-10	All										
	Torsion Bar(FrontSpringType)				61663 G63817	58817 77817					



T5500

97-09	FL1 Tilt Cab with 8100 lb Axle	22165188 22165187 22064804 22064805			83136						
	FL2 Tilt Cab with 5000 to 11000 lb Axle	22166442 22064807			83136						
	FL3 Tilt Cab with 14575 lb Axle	22165189 22064806			83136						
90-06	Tilt Cab with 15000, 19000, 21000 lb Multileaf Springs	15174902 22064232									
92-99	Tilt Cab with 19000, 21000, 23000 lb Taperleaf Springs (EXC Low Profile Veh.)	22064233									
99	Models with Hendrickson Air Suspension (Stamping number 47902-13)	12474915 15963161									

T6500

06-09	15,000lb;17,000lb; 19,000lb; 21,000lb and 23,000lb Axle	88982687									
04-09	FL1 Tilt Cab with 8100 lb Axle	22165188 22165187 22064804 22064805			83136						

APPLICATION GUIDE

Year	Fitment Notes	OEM#								
			Fleetline/ Gas SLX	Classic/ Ultra/ ProGuard/ Guardian	Max Control/ LTV Severe Duty/ Load Carrier/ HiJackers	Steering Dampers/ Steering Stabilizer/ Cab Shock	Fleetline/ Gas SLX	Classic/ Ultra/ ProGuard/ Guardian	Max Control/ LTV Severe Duty/ Load Carrier/ HiJackers	Steering Dampers/ Steering Stabilizer/ Cab Shock

GMC

GMC



T6500 (cont)

04-09	FL2 Tilt Cab with 5000 to 11000 lb Axle	22166442 22064807	I T	83136
	FL3 Tilt Cab with 14575 lb Axle	22165189 22064806	I T	83136
04-05	Tilt Cab with 15000, 19000, 21000 lb Multileaf Springs	15174902 22064232	I T	85071
03	FL1 Tilt Cab with 8100 lb Axle	22165188 22165187 22064804 22064805	I T	83136
	FL2 Tilt Cab with 5000 to 11000 lb Axle	22166442 22064807	I T	83136
	FL3 Tilt Cab with 14575 lb Axle	22165189 22064806	I T	83136
	Tilt Cab with 15000, 19000, 21000 lb Multileaf Springs	15174902 22064232	I T	85071
00-02	Low profile, with Axle Code FL1	22165187	O O	83163
	Tilt Cab with 23,000 lb Axles; Tapered Leaf Spring	22064233	I T	83136
	with 16,900lb Axle. Tapered Leaf Springs	22064489	I O	85332
	With Hendrickson Air Suspension	15963161 12474917	O O	85013
97-02	FL1 Tilt Cab with 8100 lb Axle	22165188 22165187 22064804 22064805	I T	83136
	FL2 Tilt Cab with 5000 to 11000 lb Axle	22166442 22064807	I T	83136
	FL3 Tilt Cab with 14575 lb Axle	22165189 22064806	I T	83136
	Tilt Cab with 15000, 19000, 21000 lb Multileaf Springs	15174902 22064232	I T	85071
97-99	Tilt Cab with 19000, 21000, 23000 lb Taperleaf Springs (EXC Low Profile Veh.)	22064233	I T	83136
99	Models with Hendrickson Air Suspension (Stamping number 47902-13)	12474915 15963161	O O	83122 89406
92-96	Tilt Cab with 19000, 21000, 23000 lb Taperleaf Springs (EXC Low Profile Veh.)	22064233	I T	83136
90-96	Tilt Cab with 15000, 19000, 21000 lb Multileaf Springs	15174902 22064232	I T	85071

VAN 1/2 TON, G / SAVANA

12-14	AWD, Torsion Bar(FrontSpringType)		I N	61683 G63893
08-14	All		I O	G63896	43180 ⁸ 49231 ⁷ 58638
03-14	RWD		I O	77638
	RWD, Coil(FrontSpringType)		I O	61684 G63894
03-11	Exc. Upfitter Package and Cutaway Chassis		I O	61565
	Torsion Bar (FrontSpringType)		I N	61683 G63893
07	All		I O	G63896	43180 ⁸ 49231 ⁷
03-06	All		I O	G63896	43180 ⁸ 49231 ⁷ 58638
96-02	All		I O	61555	61565 G63896	43180 ⁸ 49231 ⁷ 58638
	Exc. 8600# GVW		I O	34073 ⁸

APPLICATION GUIDE

Year	Fitment Notes	OEM#								
			Fleetline\ Gas SLX	Classic\ Ultra\ ProGuard\ Guardian	Max Control\ LTV Severe Duty\ Load Carrier\ HiJackers	Steering Dampers\ Steering Stabilizer\ Cab Shock	Fleetline\ Gas SLX	Classic\ Ultra\ ProGuard\ Guardian	Max Control\ LTV Severe Duty\ Load Carrier\ HiJackers	Steering Dampers\ Steering Stabilizer\ Cab Shock

GMC

GMC

VAN 1/2 TON, G / SAVANA (cont)

96-02	RWD			81713 ⁵ G63375 ⁵	77375	77638
78-95	All			61517 G63357	58357	61522 81496 G63413	49212 ⁷
70-95	Single System Steering Stabilizer All models with factory frame bracket. Kit 143168 required to install to linkage.			6802SE ⁸⁴								
71-77	All			61517 G63357	58357	G63306	49162 ⁷
70	All			58357	G63306	49162 ⁷
	Independent Front Suspension			61517 G63357
67-69	All			G63306	49162 ⁷
64-66	All			82003

VAN 1/2 TON, P SERIES

74-80	All			61525 81039 G63355	34036 ⁸	G63366	77662
73	All			61525 81039 G63355	34036 ⁸	61524 81164 G63349	43111 ⁸ 49155 ⁷
68-72	All			61525 81039 G63355	34036 ⁸	82003
	Coil(RearSpringType)			49107 ⁷
67	All			61525 81039 G63355	34036 ⁸	G63306	49162 ⁷

VAN 3/4 TON, G / SAVANA

25	All			61687
23-24	All	PC3Z-18124-SDA, PC3Z-18124-BBA, PC3Z-18124-BCA, PC3Z-18124-BFA, PC3Z-18124-DAA, PC3Z-18124-SAA, PC3Z-18124-DBA, PC3Z-18124-SCA		58638
24	All			61685 G63895	G63897	77638
17-23	All			61685 G63895	61687 G63897	43180 ⁸ 77638
10-16	All			61685	61687 G63897	43180 ⁸ 77638
03-16	Coil(FrontSpringType)			G63895
10-12	Torsion Bar (FrontSpringType)			G63893
03-09	All			61687 G63897	43180 ⁸ 77638
	Torsion Bar (FrontSpringType)			61683 G63893
96-02	Exc. 8600# GVV			61555 81713 ⁵ G63375 ⁵	34073 ⁸ 77375	61565 G63638	43180 ⁸ 49231 ⁷ 58638 77638
78-95	Exc. 8600# GVV			61517 G63357	58357	61522 81496 G63413	49212 ⁷

5 Use kit No. 140719 to replace O.E. hardware for lower shock absorber mounting when studs break or self-tapping screws are not longer useable;
8 Pair Packs.;

7 Pair Packs, Air hose kit included.;
84 Replacement damper for vehicles with the Gabriel Aftermarket mounting kit;

APPLICATION GUIDE

Year	Fitment Notes	OEM#								
			Fleetline/ Gas SLX	Classic/ Ultra/ ProGuard/ Guardian	Max Control/ LTV Severe Duty/ Load Carrier/ HiJackers	Steering Dampers/ Steering Stabilizer/ Cab Shock	Fleetline/ Gas SLX	Classic/ Ultra/ ProGuard/ Guardian	Max Control/ LTV Severe Duty/ Load Carrier/ HiJackers	Steering Dampers/ Steering Stabilizer/ Cab Shock

GMC

GMC

VAN 3/4 TON, G / SAVANA (cont)

70-95	Single System Steering Stabilizer All models with factory frame bracket. Kit 143168 required to install to linkage.				6802SE ⁸⁴							
71-77	All		O/O	61517 G63357	58357	O/O	G63306	49162 ⁷
67-70	All		O/O	O/O	G63306	49162 ⁷
70	Independent Front Suspension		O/O	61517 G63357	58357	O/O

VAN 3/4 TON, P SERIES

79-89	All				61525 81039 G63355	34036 ⁸	O/O	G63366
73-78	All		O/O	61525 81039 G63355	34036 ⁸	O/O	61524 81164 G63349	43111 ⁸ 49155 ⁷
68-72	All		O/O	61525 81039 G63355	34036 ⁸	O/O	G63306	49162 ⁷
67	All		O/O	82047	O/O

VAN 1 TON, G / SAVANA



25	All				O/O	61687
23-24	All	PC3Z-18124-SDA, PC3Z-18124-BBA, PC3Z-18124-BCA, PC3Z-18124-BFA, PC3Z-18124-DAA, PC3Z-18124-SAA, PC3Z-18124-DBA, PC3Z-18124-SCA	O/O	O/O	58638
24	All		O/O	61685 G63895	O/O	G63897	77638
17-23	All		O/O	61685 G63895	O/O	61687 G63897	43180 ⁸ 77638
13-16	All		O/O	61685	O/O	61687 G63897	43180 ⁸ 77638
03-16	Coil(FrontSpringType)		O/O	G63895	O/O
10-12	All		O/O	61685	O/O	43180 ⁸ 77638
03-12	Single Rear Wheels		O/O	O/O	61687 G63897
	Torsion Bar (FrontSpringType)		O/O	G63893	O/O
04-09	All		O/O	O/O	43180 ⁸ 77638
03	All		O/O	O/O	43180 ⁸
97-02	All		O/O	61555 81713 ⁵ G63375 ⁵	77375	O/O	43180 ⁸ 49231 ⁷
96-02	Exc. 8600# GVW		O/O	34073 ⁸	O/O	61565 G63638	58638 77638
92-96	Cutaway Van Exc 9200# GVW		O/O	O/O	G63671
96	All		O/O	61555 81713 ⁵ G63375 ⁵	58357 77375	O/O	43180 ⁸ 49231 ⁷
	7100, 7400 and 8600# GVW		O/O	O/O	77638
	Cutaway Van 9200# GVW		O/O	O/O	G63403

5 Use kit No. 140719 to replace O.E. hardware for lower shock absorber mounting when studs break or self-tapping screws are not longer useable.;

7 Pair Packs, Air hose kit included.;

84 Replacement damper for vehicles with the Gabriel Aftermarket mounting kit;

APPLICATION GUIDE

Year	Fitment Notes	OEM#								
			Fleetline\ Gas SLX	Classic\ Ultra\ ProGuard\ Guardian	Max Control\ LTV Severe Duty\ Load Carrier\ HiJackers	Steering Dampers\ Steering Stabilizer\ Cab Shock	Fleetline\ Gas SLX	Classic\ Ultra\ ProGuard\ Guardian	Max Control\ LTV Severe Duty\ Load Carrier\ HiJackers	Steering Dampers\ Steering Stabilizer\ Cab Shock

GMC

GMC

VAN 1 TON, G / SAVANA (cont)

96	Exc. Cutaway Van		OO	...	61522 ⁶ 81496 G63413	
94-95	HD with Straight Front Axle & Tilt Hood		OO	6804SE ⁶⁰								
93-95	Cutaway Van 9200# GVW		OO	...	G63403	77403	...	
79-95	Cutaway Van		OO	58403	...	
	Exc. Cutaway Van		OO	...	61522 ⁶ 81496 G63413	49212 ⁷	...	
78-95	All		OO	...	61517 G63357	58357	
71-95	Single System Steering Stabilizer All models with factory frame bracket. Kit 143168 required to install to linkage.		OO	6802SE ⁶⁴								
92	Cutaway Van 9200# GVW		OO	77403	...	
79-91	Cutaway Van 9200# GVW		OO	...	G63403	77403	...	
78	Cutaway Van		OO	...	61522 ⁶ 81496 G63413	49212 ⁷	...	
76-77	All		OO	...	61517 G63357	58357	...	OO	...	G63306	49162 ⁷	
75	110.0 / 279.4(WheelBase)		OO	...	61517	58357	...	OO	...	G63306	49162 ⁷	
	125.0 / 317.5(WheelBase)		OO	...	61517	58357	...	OO	...	G63306	49162 ⁷	
	146.0 / 370.8(WheelBase)		OO	...	G63357	OO	
71-74	All		OO	...	61517 G63357	58357	...	OO	...	G63306	...	
	Exc. 146" Wheelbase		OO	OO	49162 ⁷	

VAN 1 TON, P SERIES

86-99	Motorhome Chassis w/ I-Beam Front Suspension		OO	...	G63625	OO
85-99	Motorhome Chassis w/ Independent Front Suspension		OO	...	G63394	OO
75-99	All		OO	OO	...	G63366	77662
75-90	Cutaway Chassis		OO	...	61525 81039 G63355	34036 ⁸	...	OO
85	Motorhome Chassis w/ I-Beam Front Suspension		OO	...	G63403	58403 77403	...	OO
75-84	Motorhome Chassis		OO	...	G63394	OO
73-74	All		OO	OO	...	G63366	...
74	Cutaway Chassis		OO	34036 ⁸	...	OO
	Base, Cutaway Chassis		OO	...	61525 81039 G63355	OO	77662
	Motorhome		OO	...	G63394	OO	77662
73	Base, Cutaway Chassis		OO	...	61525 81039 G63355	34036 ⁸	...	OO	77662
68-72	All		OO	...	61525 81039 G63355	34036 ⁸	...	OO
	Exc. 11,000# Rear Axle		OO	OO	...	G63306	49162 ⁷

6 It is recommended that when replacing shocks on vehicles with "quad shocks" all 4 shocks should be matched by series.;



8 Pair Packs.;

84 Replacement damper for vehicles with the Gabriel Aftermarket mounting kit;

7 Pair Packs, Air hose kit included.;

80 Mounting bracket not required, install on O.E. Shock Mounts. See Ref. C for optional Steering Stabilizer Boots.;

APPLICATION GUIDE

Year	Fitment Notes	OEM#								
			Fleetline/ Gas SLX	Classic/ Ultra/ ProGuard/ Guardian	Max Control/ LTV Severe Duty/ Load Carrier/ HiJackers	Steering Dampers/ Steering Stabilizer/ Cab Shock	Fleetline/ Gas SLX	Classic/ Ultra/ ProGuard/ Guardian	Max Control/ LTV Severe Duty/ Load Carrier/ HiJackers	Steering Dampers/ Steering Stabilizer/ Cab Shock

GMC

GMC

VAN 1 TON, P SERIES (cont)

67	All		 O		82047							
----	-----	--	-------	--	-------	--	--	--	--	--	--	--

VAN, PB 1000 SERIES

63-65	All		 O		61525 81039 G63355	34036 ⁶					G63306	49162 ⁷	
-------	-----	--	-------	--	--------------------------	--------------------	--	--	--	--	--------	--------------------	--

W3500 FORWARD

00-08	Models with 11000 lb and 13000 lb suspension	9516306471 94454987 97083027 8972536200 8944549870 8944549860	 O		83515								
-------	--	--	-------	--	-------	--	--	--	--	--	--	--	--

W4500 FORWARD

00-10	Models with 11000 lb and 13000 lb Suspension	8972536510	 O								83159		
92-10	Models with 11000 lb & 13000 lb Suspension	9516306471 97083029 94454987 98232671 97083027 8972536200 8-94454-986-0 8-94454-987-0 97253620 8-97253-620-0 8944549870 8944549860	 O		83515								

W5500 FORWARD

88-10	Models with 11000 lb & 13000 lb Suspension	97253620	 O		83515								
00-09	Models with 11000 lb and 13000 lb Suspension	8972536510	 O								83159		

W6500 FORWARD

87-96	Models with 11000 lb & 13000 lb Suspension	1-51630-168-1	 O		83515								
-------	--	---------------	-------	--	-------	--	--	--	--	--	--	--	--

HINO

HINO

145

05-10	Models with O.E.M. Number	S4850-03710 48500-3710A 48500-3710	 O		83126								
-------	---------------------------	--	-------	--	-------	--	--	--	--	--	--	--	--

155

13-20	Models with O.E.M. Number	48511-80162 48511-37320	 O		83518								
		48531-37351	 O								83519		

165

05-10	Models with O.E.M. Number	S4850-03710 48500-3710A 48500-3710	 O		83126								
-------	---------------------------	--	-------	--	-------	--	--	--	--	--	--	--	--



185

05-10	Models with O.E.M. Number	S4850-03710 48500-3710A 48500-3710	 O		83126								
		48500-3720 S4850-03720	 O		83140								

195

21	Models with O.E.M. Number	48511-80162 48511-37320	 O		83518								
		48531-37362 48531-37361	 O								83519		

APPLICATION GUIDE

Year	Fitment Notes	OEM#								
			Fleetline\ Gas SLX	Classic\ Ultra\ ProGuard\ Guardian	Max Control\ LTV Severe Duty\ Load Carrier\ HiJackers	Steering Dampers\ Steering Stabilizer\ Cab Shock	Fleetline\ Gas SLX	Classic\ Ultra\ ProGuard\ Guardian	Max Control\ LTV Severe Duty\ Load Carrier\ HiJackers	Steering Dampers\ Steering Stabilizer\ Cab Shock

HINO

HINO

195 (cont)

12-20	Models with O.E.M. Number	48511-80162 48511-37320		83518				
		48531-37362 48531-37361			83519

238

08-14	Models with Hendrickson Comfort Air (Single Axle - 19K)	48530-E0100 60670-014L 60670-031L 60670-019L 60670-029L						
05-14	Models with O.E.M. Number	48500-3720 S4850-03720		83140

258

15-20	Models with O.E.M. Number	48500-E0420		83391				
08-20	Models with Hendrickson Comfort Air (Single Axle - 19K)	48530-E0100 60670-014L 48530-E0390 60670-031L 60670-019L 60670-029L			83166
06-14	Models with O.E.M. Number	48500-3720 S4850-03720		83140

258ALP

08-14	Models with Hendrickson Comfort Air (Single Axle - 19K)	48530-E0100 60670-014L 60670-031L 60670-019L 60670-029L						
					83166

268

15-20	Models with O.E.M. Number	48500-E0420		83391				
08-20	Models with Hendrickson Comfort Air (Single Axle - 19K)	48530-E0100 60670-014L 48530-E0390 60670-031L 60670-019L 60670-029L			83166
05-14	Models with O.E.M. Number	48500-3720 S4850-03720		83140

268, 268A SERIES

	Models with Hendrickson Rear Air Suspension (Shock stamping #)	60670-012						
					83168

268A

08-14	Models with Hendrickson Comfort Air (Single Axle - 19K)	48530-E0100 60670-014L 60670-031L 60670-019L 60670-029L						
	Models with O.E.M. Number	48500-3720 S4850-03720		83140

ADDITIONAL APPLICATIONS

	Conventional Hino Models with Hendrickson Comfort Air Suspension	60670-020						
	Conventional Hino Models with Hendrickson Comfort Air Suspension (19,000 lb & 21,000 lb Capacity)	60670-013			83148



FA, FB SERIES

98	FA1517, FA1817, FB1817				
					G63419

FA14

89-91	FA, FB Models Trucks with:	S4853-01910						
					83216

APPLICATION GUIDE

Year	Fitment Notes	OEM#								
			Fleetline/ Gas SLX	Classic/ Ultra/ ProGuard/ Guardian	Max Control/ LTV Severe Duty/ Load Carrier/ HiJackers	Steering Dampers/ Steering Stabilizer/ Cab Shock	Fleetline/ Gas SLX	Classic/ Ultra/ ProGuard/ Guardian	Max Control/ LTV Severe Duty/ Load Carrier/ HiJackers	Steering Dampers/ Steering Stabilizer/ Cab Shock

HINO

FA14 (cont)

89-91	Models with O.E.M. Number	S4850-01950 48500-1950 48500-2750 S4850-02750 66639	↓ O	G63610
-------	---------------------------	---	--------	-------	--------	-------	-------	-------	-------	-------	-------

HINO

FA15

92	FA, FB Models Trucks with:	S4850-01950 48500-1950 48500-2750 S4850-02750 66639	↓ O	G63610
		S4853-02510 S4853-01910 48530-2510 34802 48530-1910	↓ O	83216

FA1415

93-97	(FA15)	48500-1950	↓ O	G63610
		48530-1910	↓ O	83216
	FA, FB Models Trucks with:	S4850-01950 48500-1950 48500-2750 S4850-02750 66639	↓ O	G63610
		S4853-02510 S4853-01910 48530-2510 34802 48530-1910	↓ O	83216
		FA1415 (FA15), FB1715 (FB15)	↓ O	G63610
			48530-1910	↓ O	83216

FA1517

98-04	FA, FB Models Trucks with:	S4850-01950 48500-1950 48500-2750 S4850-02750 66639	↓ O	G63610
		S4853-02510 S4853-01910 48530-2510 34802 48530-1910	↓ O	83216
98	All	48530-2510	↓ O	83216
	FA1517, FA1817, FB1817	48530-2510	↓ O	83216

FA1817

98	All	48530-2510	↓ O	83216
----	-----	------------	--------	-------	-------	-------	-------	-------	-------	-------	-------



FB14

89-91	FA, FB Models Trucks with:	S4850-01950 48500-1950 48500-2750 S4850-02750 66639	↓ O	G63610
		S4853-02510 S4853-01910 48530-2510 34802 48530-1910	↓ O	83216

FB15

92	FA, FB Models Trucks with:	S4850-01950 48500-1950 48500-2750 S4850-02750 66639	↓ O	G63610
----	----------------------------	---	--------	-------	--------	-------	-------	-------	-------	-------	-------

APPLICATION GUIDE

Year	Fitment Notes	OEM#								
			Fleetline\ Gas SLX	Classic\ Ultra\ ProGuard\ Guardian	Max Control\ LTV Severe Duty\ Load Carrier\ HiJackers	Steering Dampers\ Steering Stabilizer\ Cab Shock	Fleetline\ Gas SLX	Classic\ Ultra\ ProGuard\ Guardian	Max Control\ LTV Severe Duty\ Load Carrier\ HiJackers	Steering Dampers\ Steering Stabilizer\ Cab Shock

HINO

HINO

FB15 (cont)

92	FA, FB Models Trucks with:	S4853-02510 S4853-01910 48530-2510 34802 48530-1910	83216
----	----------------------------	---	-----	-----	-----	-----	-----	-------	-----	-----	-----

FB1715

93-97	FA, FB Models Trucks with:	S4850-01950 48500-1950 48500-2750 S4850-02750 66639	...	G63610
		S4853-02510 S4853-01910 48530-2510 34802 48530-1910	83216
	FA1415 (FA15), FB1715 (FB15)	48500-1950	...	G63610
		48530-1910	83216

FB1817

98-04	FA, FB Models Trucks with:	S4850-01950 48500-1950 48500-2750 S4850-02750 66639	...	G63610
		S4853-02510 S4853-01910 48530-2510 34802 48530-1910	83216
	FE Models Trucks with:	S4850-01941 48500-1941	...	83141
98	All	48530-2510	83216
	FA1517, FA1817, FB1817	48530-2510	83216

FD16

86-87	Models with O.E.M. Number	48530-1880	83215
-------	---------------------------	------------	-----	-----	-----	-----	-----	-------	-----	-----

FD17

88-92	Models with O.E.M. Number	48530-1880	83215
-------	---------------------------	------------	-----	-----	-----	-----	-----	-------	-----	-----

FD2218

93-97	(FD5H). FE5H, FF5H	48500-1801	...	83216
		48530-1880	83215

FD2218LD

93-97	(FD5H). FE5H, FF5H	48530-1880	83215
-------	--------------------	------------	-----	-----	-----	-----	-----	-------	-----	-----

FD2218LP

93-97	Models with O.E.M. Number	48500-1801	...	83216
		48530-1880	83215

FE SERIES

98-04	Models Trucks with O.E.M. Number	S4850-01941 48500-1941	...	83141
-------	----------------------------------	---------------------------	-----	-------	-----	-----	-----	-----	-----	-----





FE16

86-87	All	48500-1801	...	83216
-------	-----	------------	-----	-------	-----	-----	-----	-----	-----	-----

FE2620

98	All	48530-1880	83215
----	-----	------------	-----	-----	-----	-----	-----	-------	-----	-----

APPLICATION GUIDE

Year	Fitment Notes	OEM#								
			 Fleetline/ Gas SLX	Classic/ Ultra/ ProGuard/ Guardian	Max Control LTV Severe Duty/ Load Carrier/ HiJackers	Steering Dampers/ Steering Stabilizer/ Cab Shock	 Fleetline/ Gas SLX	Classic/ Ultra/ ProGuard/ Guardian	Max Control LTV Severe Duty/ Load Carrier/ HiJackers	Steering Dampers/ Steering Stabilizer/ Cab Shock

HINO

HINO

GC17

90-91	GC17	48500-1801	OO	83216
-------	------	------------	----	-------	------	------	------	------	------	------	------

GC20

92	GC20	48500-1801	OO	83216
----	------	------------	----	-------	------	------	------	------	------	------	------

L6

22-24	Models with Hendrickson Comfort Air (Single Axle - 19K)	48530-E0100 60670-014L 48530-E0390 60670-031L 60670-019L 60670-029L	OO	83166	OO	83166
	Models with O.E.M. Number	48500-E0420	OO	83391	OO	83166
21-24	Models with Hendrickson Comfort Air (Single Axle - 19K, 21K & 23K)	48530-E0100 48530-E0390 60670-030L 60670-031 48530-E0290 60670-029L	OO	83166	OO	83166
21	Models with Hendrickson Comfort Air (Single Axle - 19K)	48530-E0100 60670-014L 60670-031L 60670-019L 60670-029L	OO	83166	OO	83166
	Models with O.E.M. Number	48500-E0420	OO	83391	OO	83166

INTERNATIONAL

INTERNATIONAL

1200D

69-70	1/2 Ton, 3/4 Ton & Travelall		OO	6802SE ⁸⁴							
-------	------------------------------	--	----	----------------------	--	--	--	--	--	--	--

1300D

69-70	1/2 Ton, 3/4 Ton & Travelall		OO	6802SE ⁸⁴							
-------	------------------------------	--	----	----------------------	--	--	--	--	--	--	--

4200

02-10	With 10,000lb - 14,000lb Axle	3533357C1	OO	85928	OO	85927
	with 6,000lb - 8,000lb Axle	3533356C1	OO	85957	OO	85927
	with Tapered Rail, 5.6" Ride Height, W/IAS Suspension	3553628C1	OO	85927	OO	85927

5500I

00-14	Chalmers 854-46	800781	OO	89425	OO	89425
	Hendrickson HAS-402 Air Ride Suspension	60675-003L	OO	85976	OO	85976
		59305-1	OO	85979	OO	85979

8500 TRANSTAR

08-11	Models with International 40,000lb Rear Air Suspension	3549099C1 3549099C2	OO	89458	OO	89458
-------	--	------------------------	----	-------	------	------	------	------	----	-------	------	------	------



8600 TRANSTAR

12-18	Models with 10,000 to 14,000 lb Front Axle	6127714C1 3588209C1 3533357C1	OO	85957	OO	89458
	Models with International 40,000lb Rear Air Suspension	3549099C3	OO	89458	OO	89458
08-11	Models with International 40,000lb Rear Air Suspension	3549099C3 3549099C2	OO	89458	OO	89458

CF500

06-09	w/ vari-rate suspension	3586902C2	OO	83364	OO	83364
-------	-------------------------	-----------	----	-------	------	------	------	------	----	-------	------	------	------

APPLICATION GUIDE

Year	Fitment Notes	OEM#								
			Fleetline\ Gas SLX	Classic\ Ultra\ ProGuard\ Guardian	Max Control\ LTV Severe Duty\ Load Carrier\ HiJackers	Steering Dampers\ Steering Stabilizer\ Cab Shock	Fleetline\ Gas SLX	Classic\ Ultra\ ProGuard\ Guardian	Max Control\ LTV Severe Duty\ Load Carrier\ HiJackers	Steering Dampers\ Steering Stabilizer\ Cab Shock

INTERNATIONAL

CV515

24	Models with 11K, 13.5K or 15.5K VARI-RATE Rear Suspension	4208946C1 4206863C1	OIO	83397	OIO	83398
	Models with Taperleaf Front	4109582C1 4089293C1 4109583C1 4207304C1	OIO	83397	OIO	83398

INTERNATIONAL

DURASTAR

16-20	Models with 10,500 or 13,500 lb Vari-Rate Rear Spring Suspension	6127087C1 3586902C2 3586902C3	OIO	83163	OIO	83364
	Models with 11,000 lb to 14,000 lb Front axle	6127714C1	OIO	85928	OIO	83364
15-20	Models with 6,000 to 8,000 lb Front Suspension	6127688C1 3533356C3	OIO	83169	OIO	83169
	Models with Hendrickson HAS - 230 or 460 Rear Air Suspension	60675-003 H60675-003 3514952C1 60675-003L 57905-001	OIO	83169	OIO	85976
	Models with O.E.M. Number	2509223C92 2509223C91 2509221C91	OIO	83054	83054	OIO	83054
16-19	Models with 20,000 lb International IROS Air Suspension	6127713C1	OIO	85656	OIO	85656
15-19	Models with 9,000 to 10,000 lb Front Suspension	6127088C1 OE13402S 3578105C2 3578105C1	OIO	83163	OIO	83163
16-17	Models with Vari-Rate Rear Spring Suspension	6127700C1	OIO	83395	OIO	83395
15	Models with 12,000 lb Front axle	3533357C1 3533357C2 3533357C3	OIO	85957	OIO	85957
13	Models with 12,000 lb Front axle	3533357C1 3533357C2 3533357C3	OIO	85957	OIO	85957
	Models with 22,000 lb Rear Spring Suspension	501906C91 501906C92 OE13424S	OIO	83317	OIO	83317
	Models with 6,000 to 8,000 lb Front Suspension	6127688C1 3533356C3	OIO	83169	OIO	83169
	Models with 9,000 to 10,000 lb Front Suspension	6127088C1 OE13402S 3578105C2 3578105C1	OIO	83163	OIO	83163
	Models with Hendrickson HAS - 230 or 460 Rear Air Suspension	60675-003 H60675-003 3514952C1 60675-003L 57905-001	OIO	85976	OIO	85976
	Models with O.E.M. Number	2509223C92 2509223C91 2509221C91	OIO	83054	83054	OIO	83054



DURASTAR - 1000 SERIES

1300 Models	66400 56110-T8123 56110-T8129	OIO	G63432	OIO	G63432
-------------	-------------------------------------	-----	--------	------	------	------	------	-----	--------	------	------	------	------

DURASTAR - 4300, 4400 SERIES

16-20	Models with 20,000 lb International IROS Air Suspension To 2015	3578858C1 3578858C2	OIO	85656	OIO	85656
	Models with International IROS Air Suspension	3553628C1 3553628C2 3553628C3 3553628C4	OIO	85927	OIO	85927
	Models with O.E.M. Number	6127690C1	OIO	85923 89458	OIO	85923 89458
16-20	Models with 11,000 lb to 14,000 lb Front axle	6127714C1	OIO	85928	OIO	85928

APPLICATION GUIDE

Year	Fitment Notes	OEM#								
			Fleetline/ Gas SLX	Classic/ Ultra/ ProGuard/ Guardian	Max Control/ LTV Severe Duty/ Load Carrier/ HiJackers	Steering Dampers/ Steering Stabilizer/ Cab Shock	Fleetline/ Gas SLX	Classic/ Ultra/ ProGuard/ Guardian	Max Control/ LTV Severe Duty/ Load Carrier/ HiJackers	Steering Dampers/ Steering Stabilizer/ Cab Shock

INTERNATIONAL

DURASTAR - 4300, 4400 SERIES (cont)

16-19	Models with 20,000 lb International IROS Air Suspension	6127713C1		OO	85656
13-18	Models with 6,000 to 8,000 lb Front Suspension	6127688C1 3533356C3	OO	83169	OO
10-15	Models with 12,000 lb Front axle	3533357C1 3533357C2 3533357C3	OO	85957	OO
10-12	Models with 6,000 to 8,000 lb Front Suspension	3533356C1 3533356C2	OO	83135	OO
	School Bus models with 6,000 to 8,000 lb Front Suspension	3533356C1 3533356C2	OO	83135	OO
10-11	Models with 40,000 lb Rear Air Suspension	3549099C2	OO	OO	85923 89458

EMV607

23	Models with 12,000 lb Parabolic Taper Leaf Springs	6127714C1	OO	85928	OO
----	--	-----------	----	-------	------	------	------	----	------	------	------	------

M1100 / M1200

68-72	All		OO	82007	OO	61500 81147 G63405	43048 ⁸ 49310 ⁷
	1/2 & 3/4 Ton with I-Beam Axle		OO	6802SE ⁸⁴								

M1400

69	All		OO	82007	OO	61500 81147 G63405	43048 ⁸ 49310 ⁷
	1/2 & 3/4 Ton with I-Beam Axle		OO	6802SE ⁸⁴								

MV60E

25	Models with 11,000 lb to 14,000 lb Taper Leaf Springs	6127714C1	OO	85928	OO
	with IROS 20k Rear	6127666C1		OO	85656

MV607

20-22	Models with 20,000 lb International IROS Air Suspension	6127713C2		OO	85656
19-22	Models with 11,000 lb to 14,000 lb Taper-leaf Springs	6127714C1	OO	85928	OO
	Models with 6,000 to 8,000 lb Front Suspension	4164146C1 6127688C1	OO	83169	OO
	Models with 9,000 to 10,000 lb Front Suspension	6127088C1	OO	83163	OO
	Models with Hendrickson HAS - 230 or 460 Rear Air Suspension	60675-003 H60675-003 3514952C1 60675-003L		OO	85976
	Models with International 21,000 lb Rear Air Suspension	6127666C1		OO	85642

TERRASTAR



12-18	Models with 10,500 or 13,500 lb Vari-Rate Rear Spring Suspension	6127087C1 3586902C2 3586902C3		OO	83364
	Models with 6,000 to 7,000 lb Front Axle	3989717C1 3991991C1 OE 18513 3902993C1 3902993C3 OE17103	OO	83135	OO
14	4 WD Models with Rear Spring Suspension	6127096C1 3945165C1		OO	83180

INTERNATIONAL

7 Pair Packs, Air hose kit included.;

8 Pair Packs.;

APPLICATION GUIDE

Year	Fitment Notes	OEM#								
			Fleetline\ Gas SLX	Classic\ Ultra\ ProGuard\ Guardian	Max Control\ LTV Severe Duty\ Load Carrier\ HiJackers	Steering Dampers\ Steering Stabilizer\ Cab Shock	Fleetline\ Gas SLX	Classic\ Ultra\ ProGuard\ Guardian	Max Control\ LTV Severe Duty\ Load Carrier\ HiJackers	Steering Dampers\ Steering Stabilizer\ Cab Shock

ISUZU

ISUZU

ADDITIONAL APPLICATIONS

85	KS22 Models (All)	8-97083-027-0		83515
		9-51630-666-2 9-51630-666-0	

ALL MODELS WITH

	Models with O.E.M. Number	8-97253-623-0 8-97253-621-0 8-97253-616-0 898098-1270		83515
--	---------------------------	--	--	-------	------	------	------	------	------	------	------

FRR

00-04	All	1-51630-219-1 1-51630-219-0 51630219		83114
95-98	All	1-51630-219-1 1-51630-219-0 51630219		83114

FSR

86	Models with O.E.M. Number	1-51630-217-1		83114
		1-51630-160-0		83162
		51630168 1-51630-168-1		83515

FTR

18-24	Models with Hendrickson HAS suspension	8-97517-966-1 60670-005 60670-005L 8-97517-966-0	
18-20	FTR Diesel Models with Std Cab	8-98321-912-1		85071
00-11	Models with Hendrickson HAS suspension	8-97517-966-1 60670-005 60670-005L 8-97517-966-0	
05-09	Models with O.E.M. Number	98098127 8-98232672-0 8-98098-127-0		83515
		98098059 8-98098-059-0 8-98098-059-1 8-98316-228-0	
97-09	Models with 19000, 21000, 23000 lb Taperleaf Springs (EXC Low Profile Veh.)	8-22064233-0	
90-09	Models with 15000, 19000, 21000 lb Multileaf Springs	15174902 8-22064232-0 88982686	
	Models with O.E.M. Number	88982682 8-22064-806-0 8-22064-807-0 15123676		83136
88-96	Models with O.E.M. Number	1-51630-167-0	



FVR

	Models with Hendrickson HAS suspension	12474915	
--	--	----------	--	------	------	------	------	------	------	------	------

HVR

05-08	Conventional Cab W/15000, 19000, 21000lb Multi Leaf Springs	88982686 22064232	
	Conventional Cab with OEM Number,	88982682 15192385 15174298 15588554 15887728 15174898 22064230 15123676		83136

APPLICATION GUIDE

Year	Fitment Notes	OEM#								
			Fleetline/ Gas SLX	Classic/ Ultra/ ProGuard/ Guardian	Max Control/ LTV Severe Duty/ Load Carrier/ HiJackers	Steering Dampers/ Steering Stabilizer/ Cab Shock	Fleetline/ Gas SLX	Classic/ Ultra/ ProGuard/ Guardian	Max Control/ LTV Severe Duty/ Load Carrier/ HiJackers	Steering Dampers/ Steering Stabilizer/ Cab Shock

ISUZU

ISUZU

HVR (cont)

05-08	Models with Hendrickson Air Suspension	12474915 15963161	O	83122
	Truck Cabs with Link Cabmate Model GMC104TK	1201-0054	O	83021



NPR

95-20	Models with O.E.M. Number	98098059 8-97253-665-0 98098058 8-97253-651-2 8-97253-664-0 97253664 98316227 97253665 97253651 8-98098-058-0 8-98098-058-1 8-98098-059-0 8-98098-059-1 8-98316227-0 8-98316-228-0	O	83159
86-20	Models with O.E.M. Number	8-97253-620-1 98098125 8-98381-012-0 97083029 94454987 98232671 8-98381-010-0 97083027 8-98232671-1 8-98232671-0 97253620 8-94454-647-1 8-97253-620-0 8-98098-125-0 8-97083-027-0 9-51630-647-1 8-97083-029-0 51630647 94454986 8-94454-986-0 8-94454-987-0	83515	O
86-95	All	9-51630-666-2 51630666 9-51630-666-0	O	85012 89413
84-85	Models with O.E.M. Number	8-97253-620-1 98098125 8-98381-012-0 97083029 94454987 98232671 8-98381-010-0 97083027 8-98232671-1 8-98232671-0 97253620 8-94454-647-1 8-97253-620-0 8-98098-125-0 8-97083-027-0 9-51630-647-1 8-97083-029-0 51630647 94454986 8-94454-986-0 8-94454-987-0	83515	O

NPR-HD

20-23	Models with 14,000 to 15,000 lb Rear	8-98380-746-0	O	83159
	Models with 15,000 to 16,000 lb Rear	8-98380-747-0	O	83159
03-23	Models with O.E.M. Number	98098059 8-97253-665-0 98098058 8-98098-058-0 8-98098-058-1 8-98098-059-0 8-98098-059-1 8-98316227-0 8-98316-228-0 98316227 97253665	O	83159

APPLICATION GUIDE

Year	Fitment Notes	OEM#								
			Fleetline\ Gas SLX	Classic\ Ultra\ ProGuard\ Guardian	Max Control\ LTV Severe Duty\ Load Carrier\ HiJackers	Steering Dampers\ Steering Stabilizer\ Cab Shock	Fleetline\ Gas SLX	Classic\ Ultra\ ProGuard\ Guardian	Max Control\ LTV Severe Duty\ Load Carrier\ HiJackers	Steering Dampers\ Steering Stabilizer\ Cab Shock

ISUZU

ISUZU

NPR-HD (cont)

99-23	Models with O.E.M. Number	8-97253-620-1 98098125 8-98381-012-0 97083029 94454987 98232671 8-98381-010-0 97083027 8-98232671-1 8-98232671-0 97253620 8-94454-647-1 8-97253-620-0 8-98098-125-0 8-97083-027-0 9-51630-647-1 8-97083-029-0 51630647 94454986 8-94454-986-0 8-94454-987-0	 O	83515				
-------	---------------------------	---	-------	-------	------	------	------	--	--	--	--

NPR-XD

23	Models with 14,000 to 15,000 lb GVW	8-98381-010-0	 O	83515					
		8-98380-746-0	 O	 O	83159
	Models with 15,000 to 16,000 lb GVW	8-98381-012-0	 O	83515	 O
		8-98380-747-0	 O	 O	83159
15-22	Models with 14,000 to 15,000 lb GVW	8-98381-010-0	 O	83515	 O
		8-98380-746-0	 O	 O	83159
	Models with 15,000 to 16,000 lb GVW	8-98381-012-0	 O	83515	 O
		8-98380-747-0	 O	 O	83159



NQR

20-23	Models with 15,000 to 16,000 lb Rear	8-98380-747-0					
94-23	Models with O.E.M. Number	8-97253-620-1	 O	83515				
		98098125									
		8-98381-012-0									
		97083029									
		94454987									
		98232671									
		8-98381-010-0									
		97083027									
		8-98232671-1									
		8-98232671-0									
		97253620									
		8-94454-647-1									
		8-97253-620-0									
8-98098-125-0											
8-97083-027-0											
9-51630-647-1											
8-97083-029-0											
51630647											
94454986											
8-94454-986-0											
8-94454-987-0											
03-19	Models with O.E.M. Number	98098059	 O				
		8-97253-665-0									
		8-98098-059-0									
		8-98098-059-1									
		8-98343986-0									
8-98316-228-0											
97253665											
98343986											
02	Diesel	8-97253-664-0					
		97253664									
95-97	Diesel	8-97253-664-0					
		97253664									

NRR

20-23	Models with 15,000 to 16,000 lb Rear	8-98380-747-0					
-------	--------------------------------------	---------------	--	------	------	------	------	--	--	--	--

APPLICATION GUIDE

Year	Fitment Notes	OEM#								
			Fleetline/ Gas SLX	Classic/ Ultra/ ProGuard/ Guardian	Max Control/ LTV Severe Duty/ Load Carrier/ HiJackers	Steering Dampers/ Steering Stabilizer/ Cab Shock	Fleetline/ Gas SLX	Classic/ Ultra/ ProGuard/ Guardian	Max Control/ LTV Severe Duty/ Load Carrier/ HiJackers	Steering Dampers/ Steering Stabilizer/ Cab Shock

ISUZU

ISUZU

NRR (cont)

05-23	Models with O.E.M. Number	8-97253-620-1 98098125 8-98381-012-0 97083029 94454987 98232671 8-98381-010-0 97083027 8-98232671-1 8-98232671-0 97253620 8-94454-647-1 8-97253-620-0 8-98098-125-0 8-97083-027-0 9-51630-647-1 8-97083-029-0 51630647 94454986 8-94454-986-0 8-94454-987-0	 O	83515	
05-19	Models with O.E.M. Number	98098059 8-97253-665-0 8-98098-059-0 8-98098-059-1 8-98343986-0 8-98316-228-0 97253665 98343986	 O	 O	83159
88-94	All	1-51630-219-1 1-51630-217-1 1-51630-217-0 51630217	 O	83114
	Models with O.E.M. Number	8-97253-620-1 98098125 8-98381-012-0 97083029 94454987 98232671 8-98381-010-0 97083027 8-98232671-1 8-98232671-0 97253620 8-94454-647-1 8-97253-620-0 8-98098-125-0 8-97083-027-0 9-51630-647-1 8-97083-029-0 51630647 94454986 8-94454-986-0 8-94454-987-0	 O	83515

REACH

11-15	Models with O.E.M. Number	8-98381-010-0	 O	83515
		8-98380-746-0	 O	 O	83159

KENWORTH

KENWORTH



K270

13-24	Models with 10,000 lb to 12,000 lb Front Axle	1707378PAC BFRG 072	 T	85182	
	Models with Hendrickson HAS - 210L or HAS - 230L Rear Air Suspension	60670-008 60670-008L	 T	 O	83123 89405
	Models with Hendrickson HAS - 230 Rear Air Suspension	60670-005 60670-005PLUS-2 60670-005L	 T	 O	83137
	Models with Reyco 102 or 79KB Suspension (Drive Axle)	19495-01 16725-01	 T	 O	83126 89430

T170

08-22	Models with Reyco 79KB Rear Steel Spring Suspension	19495-01 16725-01	 T	 O	83126 89430
08-21	Models with 8,000 lb Taper Leaf Front Springs	665617	 O	85031

APPLICATION GUIDE

Year	Fitment Notes	OEM#								
			Fleetline\ Gas SLX	Classic\ Ultra\ ProGuard\ Guardian	Max Control\ LTV Severe Duty\ Load Carrier\ HiJackers	Steering Dampers\ Steering Stabilizer\ Cab Shock	Fleetline\ Gas SLX	Classic\ Ultra\ ProGuard\ Guardian	Max Control\ LTV Severe Duty\ Load Carrier\ HiJackers	Steering Dampers\ Steering Stabilizer\ Cab Shock

KENWORTH T270

KENWORTH

24	Models with AG210L Rear Air Suspension	C71-1017 C71-1011			85069
20-23	Models with Air Glide 400L (AG400L) Rear Air Suspension	C71-1017			85069
08-23	Models with AG210L Rear Air Suspension	C71-1017 C71-1011			85069 89455
	Models with Hendrickson HAS - 210L or HAS - 230L Rear Air Suspension	60670-008 60670-008L			83123 89405
	Models with Hendrickson HMX 400/460 Haulmax with 16.5" Saddle	60680-004L 60680-004 64178-001			83143
15-22	Models with 10,000 lb to 14,600 lb Taperleaf Springs and Set Back Front Axles	B71-6019		85989
	Models with 16,000 lb to 20,000 lb Taperleaf Springs and Set Back Front Axles	B71-6020		85989
08-22	Models with Hendrickson Primaax 230, 232, 460, 462, 690 and 692 Air Suspension (8-1/2" to 10" Ride Height)	60657-003 60657-003L			85072
10-14	Models with 10,000 lb to 12,000 lb Front Axle	B71-6005		85084
	Models with 13,200 lb to 14,600 lb Front Axle	B71-6006		85084
	Models with 8,000 lb Front Axle	B71-6004		85084
08-14	Models with Hendrickson HAS - 400 (Standard) Rear Air Suspension	60670-005 60670-005L			83137
08-10	Models with 12,000 lb Front Axle	665617		85031

T280

21-24	Models with Reyco 102 or 79KB Suspension (Drive Axle)	19495-01			83126 89430
24	Models with 10,000 lb to 12,000 lb Mono-leaf front springs	B71-6019		85989

LION

LION

LION6

21-22	Models with Hendrickson Comfort Air Suspension (21K Capacity)	60670-030L 60670-030			83166
	Trucks with Hendrickson Softek Suspension (12,500 lb Capacity)	58913-010L 58913-010		85106



MACK

MACK

MD6

24	Models with 10,000 lb Taperleaf Springs	78530771 471700015341		83127
	Models with O.E.M. Number	23145372		83066	
		23159760			85188
23	Models with 10,000 lb Taperleaf Springs	78530771 471700015341		83127
	Models with O.E.M. Number	23159760			85188
		23145372		83066
21-22	Models with 10,000 lb Taperleaf Springs	78530771 471700015341		83127
	Models with O.E.M. Number	23145372		83066	

APPLICATION GUIDE

Year	Fitment Notes	OEM#								
			Fleetline/ Gas SLX	Classic/ Ultra/ ProGuard/ Guardian	Max Control/ LTV Severe Duty/ Load Carrier/ HiJackers	Steering Dampers/ Steering Stabilizer/ Cab Shock	Fleetline/ Gas SLX	Classic/ Ultra/ ProGuard/ Guardian	Max Control/ LTV Severe Duty/ Load Carrier/ HiJackers	Steering Dampers/ Steering Stabilizer/ Cab Shock

MACK

MACK

MD6 (cont)

21-22	Models with O.E.M. Number	23159760								85188			
-------	---------------------------	----------	--	--	--	--	--	--	--	-------	--	--	--

MARMON HERRINGTON

MARMON HERRINGTON

57 GLIDER

96-97	Conventional Tractors with Link Cabmate Model MARC57-B	1201-0054 1202-0054					83021					
90-94	Conventional Tractors with Link Cabmate Model MARC57-B	1201-0054 1202-0054					83021					

MERCEDES-BENZ

MERCEDES-BENZ

SPRINTER

07-10	All												
04-06	All			G56778									
	Exc. Dual Rear Wheels									G63918			

SPRINTER 2500

10-18	All											
-------	-----	--	--	--	--	--	--	--	--	--	--	--

SPRINTER 3500

19-20	All												
11-18	All			G57802 ⁴⁰						G64089			
10	All			G57802 ⁴⁰									

SPRINTER 3500XD

21-24	With OEM Number	907-320-33-00											
-------	-----------------	---------------	--	--	--	--	--	--	--	--	--	--	--

MITSUBISHI

MITSUBISHI

CANTER 35

00-01	With OEM Number	MB025382 MB025381										
-------	-----------------	----------------------	--	--	--	--	--	--	--	--	--	--

CANTER 55

00-05	With OEM Number	MB025382 MB025381										
-------	-----------------	----------------------	--	--	--	--	--	--	--	--	--	--

CANTER 60

01-05	With OEM Number	MB025382 MB025381										
-------	-----------------	----------------------	--	--	--	--	--	--	--	--	--	--

CANTER 75

01-05	With OEM Number	MB025382 MB025381										
-------	-----------------	----------------------	--	--	--	--	--	--	--	--	--	--



CANTER FB SERIES

01-10	Series FB7; FB8 With OEM Number	MB025382 MB025381										
-------	---------------------------------	----------------------	--	--	--	--	--	--	--	--	--	--

CANTER FE SERIES

93-95	Series FE339 With OEM Number	MB025382 MB025381										
90-95	Series FE334; FE449 With OEM Number	MB025382 MB025381										
86-95	Series FE434; FE439; FE444 With OEM Number	MB025382 MB025381										

APPLICATION GUIDE

Year	Fitment Notes	OEM#								
			Fleetline\ Gas SLX	Classic\ Ultra\ ProGuard\ Guardian	Max Control\ LTV Severe Duty\ Load Carrier\ HiJackers	Steering Dampers\ Steering Stabilizer\ Cab Shock	Fleetline\ Gas SLX	Classic\ Ultra\ ProGuard\ Guardian	Max Control\ LTV Severe Duty\ Load Carrier\ HiJackers	Steering Dampers\ Steering Stabilizer\ Cab Shock

MITSUBISHI

CANTER FE516BC

MITSUBISHI

93-99	With OEM Number	MC809390		83103
-------	-----------------	----------	------	------	------	------	--	-------	------	------	------

CANTER FH100

90-95	With OEM Number	MB025382 MB025381		83114
88-95	With OEM Number	MC809390			83103

CANTER FK SERIES

03-08	Series FK61F With OEM Number	MB025382 MB025381		83114
95-08	Series FK617 With OEM Number	MB025382 MB025381		83114
01-03	Series FK618 With OEM Number	MB025382 MB025381		83114
00	Series FK618 With OEM Number	MB02538 MB025382		83114
96-99	Series FK618 With OEM Number	MB025382 MB025381		83114
89-95	Series FK417 With OEM Number	MB025382 MB025381		83114
95	Series FK618 With OEM Number	MB02538 MB025382		83114
87-91	Series FK415 With OEM Number	MB025382 MB025381		83114
82-84	Series FK115 With OEM Number	MB025382 MB025381		83114
76-84	Series FK102 With OEM Number	MB025382 MB025381		83114

CANTER FM SERIES

76-84	Series FM215 With OEM Number	MB025382 MB025381		83114
-------	------------------------------	----------------------	--	-------	------	------	------	--	------	------	------

CANTER FN SERIES

03-08	Series FN61F With OEM Number	MB025382 MB025381		83114
-------	------------------------------	----------------------	--	-------	------	------	------	--	------	------	------

MITSUBISHI CANTER

MITSUBISHI CANTER

35

00-01	With OEM Number	MK433624 MK433614 MK433615 MC114594 MK383775 MB161497		G63299
-------	-----------------	--	--	------	------	------	------	--	------	--------	------	------

55

00-05	With OEM Number	MK433624 MK433614 MK433615 MC114594 MK383775 MB161497		G63299
-------	-----------------	--	--	------	------	------	------	--	------	--------	------	------

60

01-05	With OEM Number	MK433624 MK433614 MK433615 MC114594 MK383775 MB161497		G63299
-------	-----------------	--	--	------	------	------	------	--	------	--------	------	------

75

01-05	With OEM Number	MK433624 MK433614 MK433615 MC114594 MK383775 MB161497		G63299
-------	-----------------	--	--	------	------	------	------	--	------	--------	------	------

APPLICATION GUIDE

Year	Fitment Notes	OEM#								
			Fleetline/ Gas SLX	Classic/ Ultra/ ProGuard/ Guardian	Max Control/ LTV Severe Duty/ Load Carrier/ HiJackers	Steering Dampers/ Steering Stabilizer/ Cab Shock	Fleetline/ Gas SLX	Classic/ Ultra/ ProGuard/ Guardian	Max Control/ LTV Severe Duty/ Load Carrier/ HiJackers	Steering Dampers/ Steering Stabilizer/ Cab Shock

MITSUBISHI CANTER FB SERIES



10-19	FBA30 Series With OEM Number	MK433624 MK433614 MK433615 MC114594 MK383775 MB161497											
01-10	FB7 & FB8 Series With OEM Number	MK433624 MK433614 MK433615 MC114594 MK383775 MB161497											
93-99	FB501B Series With OEM Number	MK433624 MK433614 MK433615 MC114594 MK383775 MB161497											

MITSUBISHI CANTER

FE SERIES

10-20	FE85O Series; With OEM Number	MK433624 MK433614 MK433615 MC114594 MK383775 MB161497											
07-19	FE71C Series; With OEM Number	MK433624 MK433614 MK433615 MC114594 MK383775 MB161497											
07-13	FE83B & FE84B EU Series; With OEM Number	MK433624 MK433614 MK433615 MC114594 MK383775 MB161497											
	FE85B Series; With OEM Number	MK433624 MK433614 MK433615 MC114594 MK383775 MB161497											
05-13	FE85P Series; With OEM Number	MK433624 MK433614 MK433615 MC114594 MK383775 MB161497											
04-13	FE73D Series; With OEM Number	MK433624 MK433614 MK433615 MC114594 MK383775 MB161497											
	FE84B & FE84BV Series; With OEM Number	MK433624 MK433614 MK433615 MC114594 MK383775 MB161497											
	FE; With OEM Number	MC114595	O		G63405								
13	FE84C & FE84C EU Series; With OEM Number	MK433624 MK433614 MK433615 MC114594 MK383775 MB161497											
04-11	FE74B Series; With OEM Number	MK433624 MK433614 MK433615 MC114594 MK383775 MB161497											

APPLICATION GUIDE



Year	Fitment Notes	OEM#								
			Fleetline\ Gas SLX	Classic\ Ultra\ ProGuard\ Guardian	Max Control\ LTV Severe Duty\ Load Carrier\ HiJackers	Steering Dampers\ Steering Stabilizer\ Cab Shock	Fleetline\ Gas SLX	Classic\ Ultra\ ProGuard\ Guardian	Max Control\ LTV Severe Duty\ Load Carrier\ HiJackers	Steering Dampers\ Steering Stabilizer\ Cab Shock

MITSUBISHI CANTER FE SERIES (cont)

MITSUBISHI CANTER

02-11	FE83C Series; With OEM Number	MK433624 MK433614 MK433615 MC114594 MK383775 MB161497	o o o		G63299
99-11	FE637 AUS Series; With OEM Number	MK433624 MK433614 MK433615 MC114594 MK383775 MB161497	o o o		G63299
04-09	FE72D Series; With OEM Number	MK433624 MK433614 MK433615 MC114594 MK383775 MB161497	o o o		G63299
09	FE85S Series; With OEM Number	MK433624 MK433614 MK433615 MC114594 MK383775 MB161497	o o o		G63299
04-08	FE84P Series; With OEM Number	MK433624 MK433614 MK433615 MC114594 MK383775 MB161497	o o o		G63299
04-07	FE84P LHD Series; With OEM Number	MK433624 MK433614 MK433615 MC114594 MK383775 MB161497	o o o		G63299
02-04	FE72E & FE73E Series; With OEM Number	MK433624 MK433614 MK433615 MC114594 MK383775 MB161497	o o o		G63299
	FE82E & FE83E Series; With OEM Number	MK433624 MK433614 MK433615 MC114594 MK383775 MB161497	o o o		G63299
94-04	FE649 Series; With OEM Number	MK433624 MK433614 MK433615 MC114594 MK383775 MB161497	o o o		G63299
99-02	FE53EB & FE53EC Series; With OEM Number	MK433624 MK433614 MK433615 MC114594 MK383775 MB161497	o o o		G63299
	FE53EEV, FE53EEX & FE53EEX Series; With OEM Number	MK433624 MK433614 MK433615 MC114594 MK383775 MB161497	o o o		G63299
	FE63E Series; With OEM Number	MK433624 MK433614 MK433615 MC114594 MK383775 MB161497	o o o		G63299
98-02	FE639 LHD Series; With OEM Number	MK433624 MK433614 MK433615 MC114594 MK383775 MB161497	o o o		G63299

APPLICATION GUIDE



Year	Fitment Notes	OEM#								
			Fleetline/ Gas SLX	Classic/ Ultra/ ProGuard/ Guardian	Max Control/ LTV Severe Duty/ Load Carrier/ HiJackers	Steering Dampers/ Steering Stabilizer/ Cab Shock	Fleetline/ Gas SLX	Classic/ Ultra/ ProGuard/ Guardian	Max Control/ LTV Severe Duty/ Load Carrier/ HiJackers	Steering Dampers/ Steering Stabilizer/ Cab Shock

MITSUBISHI CANTER FE SERIES (cont)

MITSUBISHI CANTER

97-02	FE562 Series; With OEM Number	MK433624 MK433614 MK433615 MC114594 MK383775 MB161497	O/O	O/O	O/O	O/O	O/O	G63299	O/O	O/O
97-99	FE51EB Series; With OEM Number	MK433624 MK433614 MK433615 MC114594 MK383775 MB161497	O/O	O/O	O/O	O/O	O/O	G63299	O/O	O/O
93-99	FE516BC & FE517BD Series; With OEM Number	MK433624 MK433614 MK433615 MC114594 MK383775 MB161497	O/O	O/O	O/O	O/O	O/O	G63299	O/O	O/O
	FE537 Series; With OEM Number	MK433624 MK433614 MK433615 MC114594 MK383775 MB161497	O/O	O/O	O/O	O/O	O/O	G63299	O/O	O/O
	FE538E Series; With OEM Number	MK433624 MK433614 MK433615 MC114594 MK383775 MB161497	O/O	O/O	O/O	O/O	O/O	G63299	O/O	O/O
	FE638 & FE639 Series; With OEM Number	MK433624 MK433614 MK433615 MC114594 MK383775 MB161497	O/O	O/O	O/O	O/O	O/O	G63299	O/O	O/O
89-97	FE335EV Series; With OEM Number	MK433624 MK433614 MK433615 MC114594 MK383775 MB161497	O/O	O/O	O/O	O/O	O/O	G63299	O/O	O/O
85-97	FE305 Series; With OEM Number	MK433624 MK433614 MK433615 MC114594 MK383775 MB161497	O/O	O/O	O/O	O/O	O/O	G63299	O/O	O/O
84-95	FE; With OEM Number	MC114595	O/O	O/O	O/O	O/O	O/O	G63405	O/O	O/O
	With OEM Number	MK433624 MK433614 MK433615 MC114594 MK383775 MB161497	O/O	O/O	O/O	O/O	O/O	G63299	O/O	O/O
95	FE659F Series; With OEM Number	MK433624 MK433614 MK433615 MC114594 MK383775 MB161497	O/O	O/O	O/O	O/O	O/O	G63299	O/O	O/O
92-93	FE337EV Series; With OEM Number	MK433624 MK433614 MK433615 MC114594 MK383775 MB161497	O/O	O/O	O/O	O/O	O/O	G63299	O/O	O/O
85-89	FE435 Series; With OEM Number	MK433624 MK433614 MK433615 MC114594 MK383775 MB161497	O/O	O/O	O/O	O/O	O/O	G63299	O/O	O/O

APPLICATION GUIDE

Year	Fitment Notes	OEM#								
			Fleetline\ Gas SLX	Classic\ Ultra\ ProGuard\ Guardian	Max Control\ LTV Severe Duty\ Load Carrier\ HiJackers	Steering Dampers\ Steering Stabilizer\ Cab Shock	Fleetline\ Gas SLX	Classic\ Ultra\ ProGuard\ Guardian	Max Control\ LTV Severe Duty\ Load Carrier\ HiJackers	Steering Dampers\ Steering Stabilizer\ Cab Shock

MITSUBISHI FUSO

MITSUBISHI FUSO

FE

07-13	FEFE84B EU LHD Series; Model with O.E.M. Number	MK433624 MK433614 MK433615 MC114594 MK383775 MB161497		G63299
13	FE84C EU LHD Series; Model with O.E.M. Number	MK433624 MK433614 MK433615 MC114594 MK383775 MB161497		G63299
05-10	FE7 & FE8 Series; Model with O.E.M. Number	MK433624 MK433614 MK433615 MC114594 MK383775 MB161497		G63299
01-04	FE7 & FE8 Series; Model with O.E.M. Number	MK433624 MK433614 MK433615 MC114594 MK383775 MB161497		G63299
96-04	Model with O.E.M Number			77907
	Model with O.E.M. Number	MC114595		G63405
	Models with O.E.M. Number	MK433638 MA302296		G63610
87-04	Model with O.E.M. Number	MB161497		G63299
96-99	With OEM Number	MC114595		G63405
89-97	FE335EV Series; Model with O.E.M. Number	MK433615		G63299
92-93	FE337EV Series; Model with O.E.M. Number	MK433624 MK433614 MK433615 MC114594 MK383775 MB161497		G63299
87-89	FE435 Series; Model with O.E.M. Number	MK433624 MK433614 MK433615 MC114594 MK383775 MB161497		G63299
85-86	FE435 Series; Model with O.E.M. Number	MK433624 MK433614 MK433615 MC114594 MK383775 MB161497		G63299

FE SERIES

01-10	FE7 & FE8 with OE Number	MB025382 MB025381		83114
06	With OEM Number	MC114595		G63405





FE145

05-11	Models with O.E.M. Number	MK433638 MK302296		G63610
-------	---------------------------	----------------------	--	------	--------	------	------	--	------	------	------	------

FG

98-04	Model with O.E.M Number			77907
	Model with O.E.M. Number	MC714595		G63405
00-02	With OEM Number	MC114595		G63405
91	FG434, With OEM Number	MC189924 MB161741		G63405



APPLICATION GUIDE

Year	Fitment Notes	OEM#								
			 Fleetline/ Gas SLX	Classic/ Ultra/ ProGuard/ Guardian	Max Control/ LTV Severe Duty/ Load Carrier/ HiJackers	Steering Dampers/ Steering Stabilizer/ Cab Shock	 Fleetline/ Gas SLX	Classic/ Ultra/ ProGuard/ Guardian	Max Control/ LTV Severe Duty/ Load Carrier/ HiJackers	Steering Dampers/ Steering Stabilizer/ Cab Shock



MITSUBISHI FUSO

MITSUBISHI FUSO





FG SERIES

89-97	FG439 Series; With OEM Number	MC189924 MB161741		G63405
96	FG639 Series; With OEM Number	MC189924 MB161741		G63405
95	FG637 Series; With OEM Number	MC189924 MB161741		G63405

FH

88-04	Models with O.E.M. Number	MC826268		G63610
88-96	Models with O.E.M. Number	MC809390	 83103

FK

91-95	FK455 Models with 19mm Lower Mounting Pin, with OEM Number	MC814614	 85009
	FK457 Models with 19mm Lower Mounting Pin, with OEM Number	MC814614	 85009
87-95	FK415 Models with 19mm Lower Mounting Pin, with OEM Number	MC814614	 85009
95	FK190; 19mm Lower Mounting Pin, with OEM Number	MC814614	 85009
88-90	FK455 Models with O.E.M. Number	MC814614	 85009

NISSAN

NISSAN

NV1500

12-19	All			G64164
-------	-----	--	-------	-------	-------	-------	---	--------	-------	-------

NV2500

12-19	All			G64164
-------	-----	--	-------	-------	-------	-------	---	--------	-------	-------

NV3500

12-19	All			G64164
-------	-----	--	-------	-------	-------	-------	---	--------	-------	-------



PETERBILT

PETERBILT

210

08-15	Models with Reyco 102 or 79KB Suspension (Drive Axle)	19495-01 16725-01 TK19679	 83126 89430
-------	---	---------------------------------	-------	-------	-------	-------	--	-------	-------	-------



325

08-19	Models with 12000 lb Set Back Front Axle	B71-6016A B71-6016 02-02738	 85012
	Models with Reyco 102 or 79KB Suspension (Drive Axle)	19495-01 TK19679	 83126 89430
08-15	Models with 8,000 lb Front Axle	B71-6004	 85084



330

	Models with O.E.M. Number	B71-6017 02-03020	 85910
--	---------------------------	----------------------	---	-------	-------	-------	-------	-------	-------	-------

536

22-24	Models with 10,000 lb to 14,600 lb Taperleaf Springs and Set Back Front Axles	B71-6019	 85989
	Models with Air Trac Suspension (40,000 lb)	C71-6003	 85988
	Models with Peterbilt Low Air Leaf Suspension	C71-1017	 85069 89455

APPLICATION GUIDE

Year	Fitment Notes	OEM#								
			Fleetline\ Gas SLX	Classic\ Ultra\ ProGuard\ Guardian	Max Control\ LTV Severe Duty\ Load Carrier\ HiJackers	Steering Dampers\ Steering Stabilizer\ Cab Shock	Fleetline\ Gas SLX	Classic\ Ultra\ ProGuard\ Guardian	Max Control\ LTV Severe Duty\ Load Carrier\ HiJackers	Steering Dampers\ Steering Stabilizer\ Cab Shock

PLYMOUTH

PLYMOUTH







VAN 1/2 TON, PB SERIES

81-83	All			61523 ³⁵ 81096 ³⁵ G63359 ³⁵	34052 ⁸ 58359 ³⁵		61522 ⁶ 81496 G63413	43085 ⁸ 49212 ⁷
-------	-----	--	---	------	--	---	------	---	------	---------------------------------------	--	------

VAN 3/4 TON, PB SERIES

74-83	All			61523 ³⁵ 81096 ³⁵ G63359 ³⁵	34052 ⁸ 58359 ³⁵		61522 ⁶ 81496 G63413	43085 ⁸ 49212 ⁷
-------	-----	--	---	------	--	---	------	---	------	---------------------------------------	--	------











VAN 1 TON, PB SERIES

74-83	All				61522 ⁶ 81496 G63413	43085 ⁸ 49212 ⁷
	4000# Front Axle			81834 G63360 ³⁵	
	Exc. 4000# Front Axle			61523 ³⁵ 81096 ³⁵ G63359 ³⁵	34052 ⁸ 58359 ³⁵	





















RAM

RAM

2500 (SEE DODGE RAM 2500)

14-24	All				G64168
	4WD			G64009	77948	
11-24	RWD, Standard Cab Pickup			G64043	
11-13	All				77950
	4WD			G64009	77948		61716 G64013

3500 (SEE DODGE RAM 3500)

20-25	Coil Spring Suspension				43181 77976
13-25	Crew Cab Pickup Leaf Spring Suspension				G63971
21-24	4WD	6842 8082AB, 6844 9356AB, 6844 9675AB, 6844 9676AB, 9844 9357AB, 6844 9677AB, 6847 2701AC		G63673	
20-24	All	6845 0002AC, 6845 0108AC, 6844 9857AC, 6844 9366AC, 6844 9673AC, 6844 9358AC, 6844 9360AC			G64121
11-20	4WD			G63673	77948	
	RWD, Standard Cab Pickup			G64043	
14-19	Coil Spring Suspension				G64121	43181 77976
11-13	All				77950
13	Coil Spring Suspension				G64121	43181
11-12	RWD, Crew Cab Pickup				G63971

6 It is recommended that when replacing shocks on vehicles with "quad shocks" all 4 shocks

should be matched by series.;



8 Pair Packs.;

7 Pair Packs, Air hose kit included.;

35 Slight grinding of control arm opening is required to install product made before

Aug 1988.;

APPLICATION GUIDE

Year	Fitment Notes	OEM#								
			Fleetline/ Gas SLX	Classic/ Ultra/ ProGuard/ Guardian	Max Control/ LTV Severe Duty/ Load Carrier/ HiJackers	Steering Dampers/ Steering Stabilizer/ Cab Shock	Fleetline/ Gas SLX	Classic/ Ultra/ ProGuard/ Guardian	Max Control/ LTV Severe Duty/ Load Carrier/ HiJackers	Steering Dampers/ Steering Stabilizer/ Cab Shock

RAM

RAM

4500

12-18	Models with O.E.M. Number	05168295AB 05168284AC 6811 1104AB-001 6811 1105AC 6811 1105AC-001 6811 1104AB	↓ ○	85649				
		05168296AA 6811 1107AA 6811 1107AA-001	85650

5500

12-18	Models with O.E.M. Number	05168295AB 05168284AC 6811 1104AB-001 6811 1105AC 6811 1105AC-001 6811 1104AB	↓ ○	85649				
		05168296AA 6811 1107AA 6811 1107AA-001	85650	

CV

12-15	All		↓	G57206 ⁴⁰				
	Exc. Load Leveling		↓	85650	G64042

PROMASTER 1500

14-25	Left		↓	G57800 ⁴⁰				
	Right		↓	G57801 ⁴⁰	
	With OEM Number	6815 7782AF 6827 4700AB 6815 7783AD 6815 7783AF 6824 1284AC 6815 7782AD	85650	G64246

PROMASTER 2500

14-25	Left		↓	G57800 ⁴⁰				
	Right		↓	G57801 ⁴⁰	
	With OEM Number	6815 7782AF 6827 4700AB 6815 7783AD 6815 7783AF 6824 1284AC 6815 7782AD	85650	G64246



PROMASTER 3500

14-25	Left		↓	G57800 ⁴⁰				
	Right		↓	G57801 ⁴⁰	
	With OEM Number	6815 7782AF 6827 4700AB 6815 7783AD 6815 7783AF 6824 1284AC 6815 7782AD	85650	G64246

PROMASTER CITY

15-21	Left		↓	G57852 ⁴⁰				
	Right		↓	G57853 ⁴⁰	

APPLICATION GUIDE

Year	Fitment Notes	OEM#								
			Fleetline\ Gas SLX	Classic\ Ultra\ ProGuard\ Guardian	Max Control\ LTV Severe Duty\ Load Carrier\ HiJackers	Steering Dampers\ Steering Stabilizer\ Cab Shock	Fleetline\ Gas SLX	Classic\ Ultra\ ProGuard\ Guardian	Max Control\ LTV Severe Duty\ Load Carrier\ HiJackers	Steering Dampers\ Steering Stabilizer\ Cab Shock

STERLING TRUCK

STERLING TRUCK

ACTERRA

	Models with 11000 to 12000 lb Front axle	6803230300	 O	85006
01-09	Models with 10000 to 12000 lb. Taper-leaf Spring Suspension	10-12390-000	 O	85920
	Models with 6000 to 9000 lb Front axle	10-12388-000	 O	85920

BULLET 45

08-10	Models with O.E.M. Number	05168295AB 05168284AC 6811 1104AB-001 6811 1105AC 6811 1105AC-001 6811 1104AB	 O	85649
		05168296AA 6811 1107AA 6811 1107AA-001	 O	85650

BULLET 55

08-10	Models with O.E.M. Number	05168295AB 05168284AC 6811 1104AB-001 6811 1105AC 6811 1105AC-001 6811 1104AB	 O	85649
		05168296AA 6811 1107AA 6811 1107AA-001	 O	85650

THOR MOTOR COACH

THOR MOTOR COACH

RIZE

26	18M, Left Ram Promaster with OEM #6815 7795AE Strut	6815 7795AE	 O	G57800
	18M, Right Ram Promaster with OEM #6815 7795AE Strut	6815 7795AE	 O	G57801

UD

UD

1200

99-04	Models with O.E.M. Number	E61000T825 561000T825	 O	83515
-------	---------------------------	--------------------------	-------	-------	------	------	------	------	------	------	------

1300

05-07	Models with O.E.M. Number	E61000T825 561000T825	 O	83515
-------	---------------------------	--------------------------	-------	-------	------	------	------	------	------	------	------

1400

94-10	Models with O.E.M. Number	E61000T825 561000T825	 O	83515
-------	---------------------------	--------------------------	-------	-------	------	------	------	------	------	------	------

1800

89-94	Models with O.E.M. Number	56101-Z5008 56110-Z5008	 O	83114
-------	---------------------------	----------------------------	-------	-------	------	------	------	------	------	------	------

1800CS

99-04	Models with O.E.M. Number	56101-Z5008 56110-Z5008	 O	83114
-------	---------------------------	----------------------------	-------	-------	------	------	------	------	------	------	------



2000

89-94	Models with O.E.M. Number	56101-Z5008 56110-Z5008	 O	83114
-------	---------------------------	----------------------------	-------	-------	------	------	------	------	------	------	------

2600

89-13	Models with O.E.M. Number	56110-Z5014 56110-Z5017 56101-Z5014 56101-Z5017	 O	83162
-------	---------------------------	--	-------	-------	------	------	------	------	------	------	------

APPLICATION GUIDE

Year	Fitment Notes	OEM#								
			Fleetline\ Gas SLX	Classic\ Ultra\ ProGuard\ Guardian	Max Control\ LTV Severe Duty\ Load Carrier\ HiJackers	Steering Dampers\ Steering Stabilizer\ Cab Shock	Fleetline\ Gas SLX	Classic\ Ultra\ ProGuard\ Guardian	Max Control\ LTV Severe Duty\ Load Carrier\ HiJackers	Steering Dampers\ Steering Stabilizer\ Cab Shock

UD UD

UD 18HD SERIES

99-10	Models with 22.5" Tires	56110-30Z02 56101-30Z02	I O	G63610
-------	-------------------------	----------------------------	--------	------	--------	------	------	------	------	------

UD 1300

	UD 1300 Models Steer Axle	66400 56110-T8123 56110-T8129	I O	G63432
--	---------------------------	-------------------------------------	--------	------	--------	------	------	------	------	------

UD 1800 SERIES

11-13	Models with 22.5" Tires	56110-30Z02 56101-30Z02	I O	G63610
95-98	Models with 22.5" Tires	56110-30Z02 56101-30Z02	I O	G63610

UD 2000 SERIES

95-13	Models with 22.5" Tires	56110-30Z02 56101-30Z02	I O	G63610
-------	-------------------------	----------------------------	--------	------	--------	------	------	------	------	------

UPS TRUCK UPS TRUCK

VARIOUS

	Models with O.E.M. Number	P117099		O T	83120
--	---------------------------	---------	--	------	------	------	------	--------	-------	------	------	------

Numerical listing

Steering Dampers, Front Load Carrier, Rear Load Carrier

Numerical listing

Shock	POP	Alternative No.	MTG Acc. Supplied
Pos.	Year	Application	
Steering Dampers			
14017	A		142387
F	77-86	CHEVROLET PICKUP 1 TON, K30 All	
F	73-74	PICKUP 1 TON, K30 All	
F	89-91	PICKUP 1 TON, R3500 All	
F	87-88	PICKUP 1 TON, V30 All	
F	89-91	PICKUP 1 TON, V3000 / V3500 All	
F	73-86	PICKUP 3/4 TON, K20 All	
F	87	PICKUP 3/4 TON, V20 All	
F	77-86	GMC PICKUP 1 TON, K35 / K3500 All	
F	73-74	PICKUP 1 TON, K35 / K3500 All	
F	87-91	PICKUP 1 TON, V3000 / V3500 All	
F	73-86	PICKUP 3/4 TON, K25 / K2500 All	
F	87	PICKUP 3/4 TON, V2500 All	
14072	A		
F	20-24	FORD F-600 SUPER DUTY All	
F	08-24	PICKUP 1 TON, F-350 / SUPERDUTY 4WD	
F	08-24	PICKUP 3/4 TON, F-250 / SUPERDUTY 4WD	
F	08-24	PICKUP, F-450 SUPERDUTY 4 X 4	
F	08-24	PICKUP, F-550 SUPERDUTY 4 X 4	
Front Load Carrier			
34036	A		140357
F	67	CHEVROLET C20 PANEL All	
F	63-66	C30 PANEL All	
F	63-86	PICKUP 1 TON, C30 All	
F	88-91	PICKUP 1 TON, C35/3500 Cab & Chassis Exc. HD Solid Front Axle	
F	87-88	PICKUP 1 TON, R30 All	
F	89	PICKUP 1 TON, R3500 Standard Cab Pickup	
F	75-86	PICKUP 3/4 TON, C20 Crew Cab Pickup	
F	75-86	PICKUP 3/4 TON, C20 Standard Cab Pickup	
F	63-74	PICKUP 3/4 TON, C20 All	
F	87-88	PICKUP 3/4 TON, R20 Crew Cab Pickup	
F	89	PICKUP 3/4 TON, R2500 All	
F	63-80	VAN 1/2 TON, P SERIES All	
F	73-90	VAN 1 TON, P SERIES All Cutaway Chassis	
F	68-72	VAN 1 TON, P SERIES All	
F	68-89	VAN 3/4 TON, P SERIES All	
F	88-91	GMC PICKUP 1 TON, C35/3500 Cab & Chassis Exc. I Beam Front Axle	
F	67-78	PICKUP 1 TON, C35/3500 All	
F	87-91	PICKUP 1 TON, R3500 All	
F	75-86	PICKUP 3/4 TON, C25 / C2500 Cab & Chassis	
F	75-86	PICKUP 3/4 TON, C25 / C2500 Crew Cab Pickup	
F	75-86	PICKUP 3/4 TON, C25 / C2500 Standard Cab Pickup	
F	67-74	PICKUP 3/4 TON, C25 / C2500 All	
F	87-89	PICKUP 3/4 TON, R2500 All Exc. Crew Cab & Bonus Cab	
F	67-80	VAN 1/2 TON, P SERIES All	
F	74-90	VAN 1 TON, P SERIES All Cutaway Chassis	
F	73	VAN 1 TON, P SERIES Base Cutaway Chassis	
F	68-72	VAN 1 TON, P SERIES All	
F	68-89	VAN 3/4 TON, P SERIES All	
F	63-65	VAN, PB 1000 SERIES All	
34052	A		140126
F	72-93	DODGE PICKUP 3/4 TON, D200 SERIES All Exc. Heavy Duty Package	
F	99-03	VAN 1/2 TON, A / B SERIES / RAM 109.3 / 277.6 (WheelBase) Exc. 7000# GVW	
F	82-98	VAN 1/2 TON, A / B SERIES / RAM 109.6 / 278.4 (WheelBase) Exc. 7000# GVW	
F	71-80	VAN 1/2 TON, A / B SERIES / RAM All	
F	95-03	VAN 1 TON, A / B SERIES / RAM All	
F	71-94	VAN 1 TON, A / B SERIES / RAM All Exc. 4000# Front Axle	
F	71-03	VAN 3/4 TON, A / B SERIES / RAM All	
F	78-80	VAN, CB300 All Exc. 4000# Front Axle	
F	74-77	VAN, CB300 All Up through 8300# GVW	

Shock	POP	Alternative No.	MTG Acc. Supplied
Pos.	Year	Application	
34052	A (cont)		140126
F	81-83	PLYMOUTH VAN 1/2 TON, PB SERIES All	
F	74-83	VAN 1 TON, PB SERIES All Exc. 4000# Front Axle	
F	74-83	VAN 3/4 TON, PB SERIES All	
34058	B		140780
F	73-79	FORD PICKUP 1 TON, F-350 / SUPERDUTY RWD Quad Suspension Rearward of Front Axle	
F	77-91	VAN 1 TON, ECONOLINE / CLUB WAGON / SUPERDUTY RWD Quad Suspension Rearward of Front Axle	
F	75-91	VAN 1 TON, ECONOLINE / CLUB WAGON / SUPERDUTY RWD Exc. Cutaway Chassis; Quad Suspension Rearward of Front Axle	
F	75-91	VAN 3/4 TON, ECONOLINE / CLUB WAGON / SUPERDUTY RWD Quad Suspension Rearward of Front Axle	
34073	A		141041
F	92-00	CHEVROLET PICKUP 1 TON, C35/3500 All Exc. Straight Front Axle	
F	88-91	PICKUP 1 TON, C35/3500 Extended Cab Pickup Exc. Straight Front Axle	
F	88-91	PICKUP 1 TON, C35/3500 Standard Cab Pickup Exc. Straight Front Axle	
F	88-00	PICKUP 3/4 TON, C25 / C2500 All	
F	96-02	VAN 1 TON, G / EXPRESS All Exc. 8600# GVW	
F	96-02	VAN 3/4 TON, G / EXPRESS All Exc. 8600# GVW	
F	92-00	GMC PICKUP 1 TON, C35/3500 All	
F	88-91	PICKUP 1 TON, C35/3500 All Exc. HD Straight Front Axle	
F	88-00	PICKUP 3/4 TON, C25 / C2500 All	
F	96-02	VAN 1/2 TON, G / SAVANA All Exc. 8600# GVW	
F	96-02	VAN 1 TON, G / SAVANA All Exc. 8600# GVW	
F	96-02	VAN 3/4 TON, G / SAVANA All Exc. 8600# GVW	
34076	A		140780
F	92-19	FORD VAN 1 TON, ECONOLINE / CLUB WAGON / SUPERDUTY All	
F	92-14	VAN 3/4 TON, ECONOLINE / CLUB WAGON / SUPERDUTY All	
Rear Load Carrier			
43048	A		
R	61-66	FORD PICKUP 1 TON, F-350 / SUPERDUTY All	
F	68-76	PICKUP P350 All Up through 8000# GVW	
F	75-76	PICKUP P400 All Up through 8000# GVW	
R	68-72	INTERNATIONAL M1100 / M1200 All	
R	69	M1400 All	
43058	C		140739 (2); 141137 (2)
R	75-79	FORD PICKUP 1 TON, F-350 / SUPERDUTY Standard Cab Pickup, RWD	
R	73-74	PICKUP 1 TON, F-350 / SUPERDUTY Standard Cab Pickup RWD	
R	69-74	VAN 1 TON, ECONOLINE / CLUB WAGON / SUPERDUTY All	
R	69-74	VAN 3/4 TON, ECONOLINE / CLUB WAGON / SUPERDUTY All	
43085	C		140724
R	99-03	DODGE VAN 1/2 TON, A / B SERIES / RAM 109.3 / 277.6 (WheelBase) Exc. 7000# GVW	
R	81-98	VAN 1/2 TON, A / B SERIES / RAM 109.6 / 278.4 (WheelBase) Exc. 7000# GVW	
R	71-80	VAN 1/2 TON, A / B SERIES / RAM All	
R	71-03	VAN 1 TON, A / B SERIES / RAM All	
R	71-03	VAN 3/4 TON, A / B SERIES / RAM All	
R	74-80	VAN, CB300 All	
R	81-83	PLYMOUTH VAN 1/2 TON, PB SERIES All	
R	74-83	VAN 1 TON, PB SERIES All	
R	74-83	VAN 3/4 TON, PB SERIES All	

Shock	POP	Alternative No.	MTG Acc. Supplied
Pos.	Year	Application	
43099	B		140126
R	75-79	FORD PICKUP 1 TON, F-350 / SUPERDUTY Cab & Chassis, RWD	
R	75-79	PICKUP 1 TON, F-350 / SUPERDUTY Extended Cab Pickup, RWD	
R	74	PICKUP 1 TON, F-350 / SUPERDUTY RWD Supercab	
43111	C		140702
R	75-86	CHEVROLET PICKUP 3/4 TON, C20 Standard Cab Pickup	
R	73-74	PICKUP 3/4 TON, C20 All Standard Cab Pickup	
R	73-86	PICKUP 3/4 TON, K20 All Exc. Lift Kit	
R	87	PICKUP 3/4 TON, R20 Standard Cab Pickup	
R	87	PICKUP 3/4 TON, V20 All Exc. Quad Suspension and Lift Kit	
R	73	VAN 1/2 TON, P SERIES All	
R	73-78	VAN 3/4 TON, P SERIES All	
R	75-86	GMC PICKUP 3/4 TON, C25 / C2500 Cab & Chassis	
R	75-86	PICKUP 3/4 TON, C25 / C2500 Standard Cab Pickup	
R	73-74	PICKUP 3/4 TON, C25 / C2500 All	
R	73-86	PICKUP 3/4 TON, K25 / K2500 All Exc. Lift Kit	
R	88-89	PICKUP 3/4 TON, R2500 All Exc. Crew Cab & Bonus Cab	
R	87	PICKUP 3/4 TON, R2500 Cab & Chassis Exc. Crew Cab & Bonus Cab	
R	87	PICKUP 3/4 TON, R2500 Standard Cab Pickup Exc. Crew Cab & Bonus Cab	
R	87	PICKUP 3/4 TON, V2500 All Exc. Lift Kit	
R	73	VAN 1/2 TON, P SERIES All	
R	73-78	VAN 3/4 TON, P SERIES All	
43140	A		141150
R	49-52	CHEVROLET FLEETLINE All	
R	49-52	FLEETLINE TRUCK All	
R	61-62	VAN 1 TON, P SERIES All	
R	61-62	VAN 3/4 TON, P SERIES All	
43163	A		
R	91-02	CHEVROLET C3500HD All Solid Front Axle	
R	88-90	PICKUP 1 TON, C35/3500 Extended Cab Pickup Exc. HD Straight Front Axle	
R	88-90	PICKUP 1 TON, C35/3500 Standard Cab Pickup Exc. HD Straight Front Axle	
R	88-00	PICKUP 1 TON, K35 / K3500 All	
R	88-00	PICKUP 3/4 TON, C25 / C2500 All	
R	88-00	PICKUP 3/4 TON, K25 / K2500 All	
R	91-02	GMC C3500HD All Exc. I Beam Front Axle	
R	91-00	PICKUP 1 TON, C35/3500 All Exc. I Beam Front Axle	
R	88-90	PICKUP 1 TON, C35/3500 Extended Cab Pickup Exc. HD Straight Front Axle	
R	88-90	PICKUP 1 TON, C35/3500 Standard Cab Pickup Exc. HD Straight Front Axle	
R	88-00	PICKUP 1 TON, K35 / K3500 All	
R	88-00	PICKUP 3/4 TON, C25 / C2500 All	
R	88-00	PICKUP 3/4 TON, K25 / K2500 All	
43167	A		
R	97	FORD F-250 HD RWD Quad Suspension; Rearward of Front Axle	
R	80-97	PICKUP 1 TON, F-350 / SUPERDUTY RWD Exc. Dual Rear Wheels; Quad Suspension; Rearward of Front Axle	
R	97	PICKUP, F-450 SUPERDUTY All Quad Suspension; Rearward of Front Axle	
43180	A		
R	91-02	CHEVROLET C3500HD All I Beam Front Axle	
R	96-23	VAN 1 TON, G / EXPRESS All	
R	03-23	VAN 3/4 TON, G / EXPRESS All	
R	96-02	VAN 3/4 TON, G / EXPRESS All Exc. 8600# GVW	
R	96-14	GMC VAN 1/2 TON, G / SAVANA All	
R	96-23	VAN 1 TON, G / SAVANA All	
R	03-23	VAN 3/4 TON, G / SAVANA All	

Numerical listing

Shock	POP	Alternative No.	MTG Acc. Supplied
Pos.	Year	Application	
43180	A (cont)		
R	96-02	VAN 3/4 TON, G / SAVANA All Exc. 8600# GVW	
43181	A		
R	11-24	CHEVROLET PICKUP 1 TON, SILVERADO 3500 HD All	
R	11-24	PICKUP 3/4 TON, SILVERADO 2500 HD All	
R	94-02	DODGE PICKUP 1 TON, RAM 3500 (SEE RAM 3500) RWD Exc. Solid Front Axle	
R	11-24	GMC SIERRA 2500 HD All	
R	11-24	SIERRA 3500 HD All	
R	13-25	RAM 3500 (SEE DODGE RAM 3500) All Coil Spring Suspension	
HiJackers			
49107	D		141099
R	67-72	CHEVROLET PICKUP 3/4 TON, C20 All Coil(RearSpringType)	
R	67-72	VAN 1/2 TON, P SERIES All	
R	67-72	GMC PICKUP 3/4 TON, C25 / C2500 All Coil(RearSpringType)	
R	68-72	VAN 1/2 TON, P SERIES All Coil(RearSpringType)	
49127	D		140739,141137,141099
R	75-79	FORD PICKUP 1 TON, F-350 / SUPERDUTY Standard Cab Pickup, RWD	
R	73-74	PICKUP 1 TON, F-350 / SUPERDUTY Standard Cab Pickup RWD	
R	69-74	VAN 1 TON, ECONOLINE / CLUB WAGON / SUPERDUTY All	
R	69-74	VAN 3/4 TON, ECONOLINE / CLUB WAGON / SUPERDUTY All	
49149	W		141099
R	72-93	DODGE PICKUP 1 TON, D300 SERIES All	
R	82-93	PICKUP 3/4 TON, D200 SERIES All	
R	81	PICKUP 3/4 TON, D200 SERIES All Exc. Heavy Duty Package	
R	72-80	PICKUP 3/4 TON, D200 SERIES All	
49155	A		140702,141099
R	75-86	CHEVROLET PICKUP 3/4 TON, C20 Standard Cab Pickup	
R	73-74	PICKUP 3/4 TON, C20 All Standard Cab Pickup	
R	81-86	PICKUP 3/4 TON, K20 All Standard Suspension; Exc. Lift Kit	
R	73-80	PICKUP 3/4 TON, K20 All Exc. Lift Kit	
R	87	PICKUP 3/4 TON, R20 Standard Cab Pickup	
R	87	PICKUP 3/4 TON, V20 All	
R	73	VAN 1/2 TON, P SERIES All	
R	73-78	VAN 3/4 TON, P SERIES All	
R	75-86	GMC PICKUP 3/4 TON, C25 / C2500 Cab & Chassis	
R	75-86	PICKUP 3/4 TON, C25 / C2500 Standard Cab Pickup	
R	73-74	PICKUP 3/4 TON, C25 / C2500 All	
R	73-86	PICKUP 3/4 TON, K25 / K2500 All Exc. Quad Suspension and Lift Kit	
R	88-89	PICKUP 3/4 TON, R2500 All Exc. Crew Cab & Bonus Cab	
R	87	PICKUP 3/4 TON, R2500 Cab & Chassis Exc. Crew Cab & Bonus Cab	
R	87	PICKUP 3/4 TON, R2500 Standard Cab Pickup Exc. Crew Cab & Bonus Cab	
R	87	PICKUP 3/4 TON, V2500 All Exc. Lift Kit	
R	73	VAN 1/2 TON, P SERIES All	
R	73-78	VAN 3/4 TON, P SERIES All	
49162	W		141058,141099
R	67-72	CHEVROLET PICKUP 1 TON, C30 All Exc. 11,000# Rear Axle	
R	67-72	PICKUP 3/4 TON, C20 All Leaf(RearSpringType)	
R	63-66	PICKUP 3/4 TON, C20 All	
R	67-77	VAN 1/2 TON, G / EXPRESS All	
R	63-66	VAN 1/2 TON, P SERIES All	
R	76-77	VAN 1 TON, G / EXPRESS All	
R	75	VAN 1 TON, G / EXPRESS 110.0 / 279.4 (WheelBase)	
R	75	VAN 1 TON, G / EXPRESS 125.0 / 317.5 (WheelBase)	
R	71-74	VAN 1 TON, G / EXPRESS All	

Rear Load Carrier, HiJackers, LTV Severe Duty

Shock	POP	Alternative No.	MTG Acc. Supplied
Pos.	Year	Application	
49162	W (cont)		141058,141099
R	68-72	VAN 1 TON, P SERIES All Exc. 11,000# Rear Axle	
R	67-77	VAN 3/4 TON, G / EXPRESS All	
R	68-72	VAN 3/4 TON, P SERIES All	
R	67-72	GMC PICKUP 1 TON, C35/3500 All Exc. 11,000# Rear Axle	
R	67-72	PICKUP 3/4 TON, C25 / C2500 All Leaf(RearSpringType)	
R	67-77	VAN 1/2 TON, G / SAVANA All	
R	67	VAN 1/2 TON, P SERIES All	
R	76-77	VAN 1 TON, G / SAVANA All	
R	75	VAN 1 TON, G / SAVANA 110.0 / 279.4 (WheelBase)	
R	75	VAN 1 TON, G / SAVANA 125.0 / 317.5 (WheelBase)	
R	71-74	VAN 1 TON, G / SAVANA All Exc. 146" Wheelbase	
R	68-72	VAN 1 TON, P SERIES All Exc. 11,000# Rear Axle	
R	67-77	VAN 3/4 TON, G / SAVANA All	
R	68-72	VAN 3/4 TON, P SERIES All	
R	63-65	VAN, PB 1000 SERIES All	
49173	W		140126,141099
R	75-79	FORD PICKUP 1 TON, F-350 / SUPERDUTY Cab & Chassis, RWD	
R	75-79	PICKUP 1 TON, F-350 / SUPERDUTY Extended Cab Pickup, RWD	
R	74	PICKUP 1 TON, F-350 / SUPERDUTY RWD Extended Cab & Chassis Cab	
49178	B		140126,141099
R	79	FORD PICKUP 1 TON, F-350 / SUPERDUTY 4WD	
R	21-24	VAN 1 TON, ECONOLINE / CLUB WAGON / SUPERDUTY All	
R	77-19	VAN 1 TON, ECONOLINE / CLUB WAGON / SUPERDUTY All	
R	07	VAN 1 TON, ECONOLINE / CLUB WAGON / SUPERDUTY All Exc. Cutaway Chassis	
R	75-91	VAN 1 TON, ECONOLINE / CLUB WAGON / SUPERDUTY All Exc. Cutaway Chassis	
R	75-14	VAN 3/4 TON, ECONOLINE / CLUB WAGON / SUPERDUTY All	
49203	D		142261,141099
R	61-62	CHEVROLET VAN 1 TON, P SERIES All	
R	61-62	VAN 3/4 TON, P SERIES All	
49205	D		141150,141099
R	49-52	CHEVROLET FLEETLINE All	
R	49-52	FLEETLINE TRUCK All	
49212	C		141099
R	78-95	CHEVROLET VAN 1/2 TON, G / EXPRESS All	
R	78-95	VAN 1 TON, G / EXPRESS Cutaway Van	
R	78-95	VAN 3/4 TON, G / EXPRESS All Exc. 8600# GVW	
R	99-03	DODGE VAN 1/2 TON, A / B SERIES / RAM 109.3 / 277.6 (WheelBase) Exc. 7000# GVW	
R	82-98	VAN 1/2 TON, A / B SERIES / RAM 109.6 / 278.4 (WheelBase) Exc. 7000# GVW	
R	71-80	VAN 1/2 TON, A / B SERIES / RAM All	
R	71-03	VAN 1 TON, A / B SERIES / RAM All	
R	71-03	VAN 3/4 TON, A / B SERIES / RAM All	
R	78-80	VAN, CB300 All	
R	77	VAN, CB300 All Over 8300# GVW	
R	75-76	VAN, CB300 All	
R	74	VAN, CB300 All Over 8300# GVW	
R	78-95	GMC VAN 1/2 TON, G / SAVANA All	
R	85-95	VAN 1 TON, G / SAVANA Extended Cargo Van	
R	85-95	VAN 1 TON, G / SAVANA Extended Passenger Van	
R	79-95	VAN 1 TON, G / SAVANA Standard Cargo Van	
R	79-95	VAN 1 TON, G / SAVANA Standard Passenger Van	
R	78	VAN 1 TON, G / SAVANA Cutaway Van	
R	78-95	VAN 3/4 TON, G / SAVANA All Exc. 8600# GVW	
R	81-83	PLYMOUTH VAN 1/2 TON, PB SERIES All	

Numerical listing

Shock	POP	Alternative No.	MTG Acc. Supplied
Pos.	Year	Application	
49212	C (cont)		141099
R	74-83	VAN 1 TON, PB SERIES All	
R	74-83	VAN 3/4 TON, PB SERIES All	
49218	A		141099
R	91-00	CHEVROLET PICKUP 1 TON, C35/3500 All	
R	88-90	PICKUP 1 TON, C35/3500 Extended Cab Pickup	
R	88-90	PICKUP 1 TON, C35/3500 Standard Cab Pickup	
R	88-00	PICKUP 1 TON, K35 / K3500 All	
R	88-00	PICKUP 3/4 TON, C25 / C2500 All	
R	88-00	PICKUP 3/4 TON, K25 / K2500 All	
R	92-00	GMC PICKUP 1 TON, C35/3500 Cab & Chassis Exc. HD Straight Front Axle	
R	88-91	PICKUP 1 TON, C35/3500 All Exc. HD Straight Front Axle	
R	88-00	PICKUP 1 TON, K35 / K3500 All	
R	88-00	PICKUP 3/4 TON, C25 / C2500 All	
R	88-00	PICKUP 3/4 TON, K25 / K2500 All	
49231	B		141099
R	96-02	CHEVROLET VAN 1 TON, G / EXPRESS All	
R	96-02	VAN 3/4 TON, G / EXPRESS All Exc. 8600# GVW	
R	96-14	GMC VAN 1/2 TON, G / SAVANA All	
R	96-02	VAN 1 TON, G / SAVANA All	
R	96-02	VAN 3/4 TON, G / SAVANA All Exc. 8600# GVW	
49235	A		141099
R	94-02	DODGE PICKUP 1 TON, RAM 3500 (SEE RAM 3500) RWD Exc. Solid Front Axle	
R	94-02	PICKUP 3/4 TON, RAM 2500 (SEE RAM 2500) All Exc. 8800# GVW	
49310	D		140788,141099
R	68-72	INTERNATIONAL M1100 / M1200 All	
R	69	M1400 All	
49311	A		141099
R	61-67	FORD ECONOLINE All	
LTV Severe Duty			
58357	C		
F	71-95	CHEVROLET VAN 1/2 TON, G / EXPRESS All	
F	70	VAN 1/2 TON, G / EXPRESS All Independent Front Suspension	
F	78-96	VAN 1 TON, G / EXPRESS All	
F	96	VAN 1 TON, G / EXPRESS Cutaway Van	
F	75	VAN 1 TON, G / EXPRESS 146.0 / 370.8 (WheelBase)	
F	71-74	VAN 1 TON, G / EXPRESS All	
F	78-95	VAN 3/4 TON, G / EXPRESS All Exc. 8600# GVW	
F	70-77	VAN 3/4 TON, G / EXPRESS All	
F	70-95	GMC VAN 1/2 TON, G / SAVANA All	
F	76-96	VAN 1 TON, G / SAVANA All	
F	75	VAN 1 TON, G / SAVANA 110.0 / 279.4 (WheelBase)	
F	75	VAN 1 TON, G / SAVANA 125.0 / 317.5 (WheelBase)	
F	71-74	VAN 1 TON, G / SAVANA All	
F	78-95	VAN 3/4 TON, G / SAVANA All Exc. 8600# GVW	
F	71-77	VAN 3/4 TON, G / SAVANA All	
F	70	VAN 3/4 TON, G / SAVANA All Independent Front Suspension	
58359	D		140126
F	72-93	DODGE PICKUP 3/4 TON, D200 SERIES All Exc. Heavy Duty Package	
F	99-03	VAN 1/2 TON, A / B SERIES / RAM 109.3 / 277.6 (WheelBase) Exc. 7000# GVW	
F	81-98	VAN 1/2 TON, A / B SERIES / RAM 109.6 / 278.4 (WheelBase) Exc. 7000# GVW	
F	71-80	VAN 1/2 TON, A / B SERIES / RAM All	
F	95-03	VAN 1 TON, A / B SERIES / RAM All	
F	71-94	VAN 1 TON, A / B SERIES / RAM All Exc. 4000# Front Axle	
F	71-03	VAN 3/4 TON, A / B SERIES / RAM All	
F	78-80	VAN, CB300 All Exc. 4000# Front Axle	

Numerical listing

Shock	POP	Alternative No.	MTG Acc. Supplied
Pos.	Year	Application	
58359	D (cont)		140126
F	74-77	VAN, CB300 All Up through 8300# GVW	
F	81-83	PLYMOUTH VAN 1/2 TON, PB SERIES All	
F	74-83	VAN 1 TON, PB SERIES All Exc. 4000# Front Axle	
F	74-83	VAN 3/4 TON, PB SERIES All	
58403	D		
R	79-95	CHEVROLET VAN 1 TON, G / EXPRESS Cutaway Van	
F	85	VAN 1 TON, P SERIES All Motorhome Chassis w/ I-Beam Front Suspension	
R	79-95	GMC VAN 1 TON, G / SAVANA Cutaway Van	
F	85	VAN 1 TON, P SERIES All Motorhome Chassis w/ I-Beam Front Suspension	
58412	A		
R	77-86	CHEVROLET PICKUP 1 TON, K30 All	
R	90-91	PICKUP 1 TON, R3500 All	
R	89	PICKUP 1 TON, R3500 Cab & Chassis	
R	89	PICKUP 1 TON, R3500 Crew Cab Pickup	
R	01-09	PICKUP 1 TON, SILVERADO 3500 All	
R	07-10	PICKUP 1 TON, SILVERADO 3500 HD All	
R	87-88	PICKUP 1 TON, V30 All	
R	89-91	PICKUP 1 TON, V3000 / V3500 All	
R	99-08	PICKUP 3/4 TON, SILVERADO 2500 All	
R	01-10	PICKUP 3/4 TON, SILVERADO 2500 HD All	
R	07	SILVERADO 2500 HD CLASSIC All	
R	07	SILVERADO 3500 CLASSIC All	
R	77-86	GMC PICKUP 1 TON, K35 / K3500 All	
R	87-91	PICKUP 1 TON, V3000 / V3500 All	
R	99-04	SIERRA 2500 All	
R	01-10	SIERRA 2500 HD All	
R	07	SIERRA 2500 HD CLASSIC All	
R	01-06	SIERRA 3500 All	
R	07	SIERRA 3500 CLASSIC All	
R	07-10	SIERRA 3500 HD All	
58488	A		
R	91-02	CHEVROLET C3500HD All Solid Front Axle	
R	88-90	PICKUP 1 TON, C35/3500 Extended Cab Pickup Exc. HD Straight Front Axle	
R	88-90	PICKUP 1 TON, C35/3500 Standard Cab Pickup Exc. HD Straight Front Axle	
R	88-00	PICKUP 1 TON, K35 / K3500 All	
R	88-00	PICKUP 3/4 TON, C25 / C2500 All	
R	88-00	PICKUP 3/4 TON, K25 / K2500 All	
R	91-02	GMC C3500HD All Solid Front Axle	
R	98-99	PICKUP 1 TON, C35/3500 Cab & Chassis Exc. I Beam Front Axle	
R	88-97	PICKUP 1 TON, C35/3500 All Exc. I Beam Front Axle	
R	88-00	PICKUP 1 TON, K35 / K3500 All	
R	88-00	PICKUP 3/4 TON, C25 / C2500 All	
R	88-00	PICKUP 3/4 TON, K25 / K2500 All	
58489	A		141537
F	92-00	CHEVROLET PICKUP 1 TON, C35/3500 Crew Cab Pickup Exc. HD Straight Front Axle	
F	88-00	PICKUP 1 TON, C35/3500 Extended Cab Pickup Exc. HD Straight Front Axle	
F	88-00	PICKUP 1 TON, C35/3500 Standard Cab Pickup Exc. HD Straight Front Axle	
F	88-00	PICKUP 3/4 TON, C25 / C2500 All	
F	92-00	GMC PICKUP 1 TON, C35/3500 Crew Cab Pickup Exc. HD Straight Front Axle	
F	88-00	PICKUP 1 TON, C35/3500 Extended Cab Pickup Exc. HD Straight Front Axle	
F	88-00	PICKUP 1 TON, C35/3500 Standard Cab Pickup Exc. HD Straight Front Axle	
F	88-00	PICKUP 3/4 TON, C25 / C2500 All	

LTV Severe Duty, ProGuard

Shock	POP	Alternative No.	MTG Acc. Supplied
Pos.	Year	Application	
58609	A		
F	88-00	CHEVROLET PICKUP 1 TON, K35 / K3500 All	
F	88-00	PICKUP 3/4 TON, K25 / K2500 All	
F	88-00	GMC PICKUP 1 TON, K35 / K3500 All	
F	88-00	PICKUP 3/4 TON, K25 / K2500 All	
58622	W		142617
F	00-02	FORD E-450 ECONOLINE SUPER DUTY All	
F	00-06	ECONOLINE All	
F	21-26	VAN 1 TON, ECONOLINE / CLUB WAGON / SUPERDUTY All	
F	99-19	VAN 1 TON, ECONOLINE / CLUB WAGON / SUPERDUTY All	
F	04-11	VAN 1 TON, ECONOLINE / CLUB WAGON / SUPERDUTY All Exc. Cutaway Chassis	
F	07-08	VAN 1 TON, ECONOLINE / CLUB WAGON / SUPERDUTY All Cutaway Chassis	
F	92-05	VAN 1 TON, ECONOLINE / CLUB WAGON / SUPERDUTY All Cutaway Chassis	
F	92-14	VAN 3/4 TON, ECONOLINE / CLUB WAGON / SUPERDUTY All	
58623	D		142617
R	00-02	FORD E-450 ECONOLINE SUPER DUTY All	
R	00-06	ECONOLINE All	
R	21-26	VAN 1 TON, ECONOLINE / CLUB WAGON / SUPERDUTY All	
R	04-19	VAN 1 TON, ECONOLINE / CLUB WAGON / SUPERDUTY All Exc. Cutaway Chassis	
R	99-19	VAN 1 TON, ECONOLINE / CLUB WAGON / SUPERDUTY All	
R	07-08	VAN 1 TON, ECONOLINE / CLUB WAGON / SUPERDUTY All Cutaway Chassis	
R	92-05	VAN 1 TON, ECONOLINE / CLUB WAGON / SUPERDUTY All Cutaway Chassis	
R	92-14	VAN 3/4 TON, ECONOLINE / CLUB WAGON / SUPERDUTY All	
58638	A		
R	09-22	CHEVROLET EXPRESS 4500 All	
R	23-24	VAN 1 TON, G / EXPRESS All	
R	10-12	VAN 1 TON, G / EXPRESS All	
R	03-06	VAN 1 TON, G / EXPRESS All	
R	23-24	VAN 3/4 TON, G / EXPRESS All	
R	07-09	VAN 3/4 TON, G / EXPRESS All	
R	96-02	VAN 3/4 TON, G / EXPRESS All Exc. 8600# GVW	
R	08-14	GMC VAN 1/2 TON, G / SAVANA All	
R	96-06	VAN 1/2 TON, G / SAVANA All	
R	23-24	VAN 1 TON, G / SAVANA All	
R	96-02	VAN 1 TON, G / SAVANA All Exc. 8600# GVW	
R	23-24	VAN 3/4 TON, G / SAVANA All	
R	96-02	VAN 3/4 TON, G / SAVANA All Exc. 8600# GVW	
58662	C		
R	94-02	DODGE PICKUP 1 TON, RAM 3500 (SEE RAM 3500) RWD Exc. Solid Front Axle	
R	94-02	PICKUP 3/4 TON, RAM 2500 (SEE RAM 2500) All Exc. 8800# GVW	
58807	C		142617
F	22-24	FORD PICKUP 1 TON, F-350 / SUPERDUTY RWD	
F	13-16	PICKUP 1 TON, F-350 / SUPERDUTY All	
F	99-16	PICKUP 1 TON, F-350 / SUPERDUTY RWD	
F	99-24	PICKUP 3/4 TON, F-250 / SUPERDUTY RWD	
58808	W		
R	99-04	FORD PICKUP 1 TON, F-350 / SUPERDUTY RWD	
R	99-04	PICKUP 3/4 TON, F-250 / SUPERDUTY RWD	
58809	B		
F	99-04	FORD PICKUP 1 TON, F-350 / SUPERDUTY 4WD	
F	99-04	PICKUP 3/4 TON, F-250 / SUPERDUTY 4WD	
F	99-04	PICKUP, F-450 SUPERDUTY All	
F	99-04	PICKUP, F-550 SUPERDUTY All	

Numerical listing

Shock	POP	Alternative No.	MTG Acc. Supplied
Pos.	Year	Application	
58810	C		
R	99-04	FORD PICKUP 1 TON, F-350 / SUPERDUTY 4WD	
R	99-04	PICKUP 3/4 TON, F-250 / SUPERDUTY 4WD	
58817	A		141665
F	01-09	CHEVROLET PICKUP 1 TON, SILVERADO 3500 All	
F	07-10	PICKUP 1 TON, SILVERADO 3500 HD All	
F	05-08	PICKUP 3/4 TON, SILVERADO 2500 All	
F	99-04	PICKUP 3/4 TON, SILVERADO 2500 4WD	
F	01-10	PICKUP 3/4 TON, SILVERADO 2500 HD All 9200# GVW	
F	07	SILVERADO 2500 HD CLASSIC All 9200# GVW	
F	07	SILVERADO 3500 CLASSIC All Heavy Duty	
F	99-04	GMC SIERRA 2500 All	
F	01-10	SIERRA 2500 HD All	
F	01-06	SIERRA 3500 All	
F	07	SIERRA 3500 CLASSIC All	
F	07-10	SIERRA 3500 HD Torsion Bar (FrontSpringType)	
58929	D		140780
F	03-14	FORD VAN 1/2 TON, ECONOLINE / CLUB WAGON All	
58930	A		
R	75-86	CHEVROLET PICKUP 1 TON, C30 All	
R	88-91	PICKUP 1 TON, C35/3500 Cab & Chassis Exc. HD Solid Front Axle	
R	87-88	PICKUP 1 TON, R30 All	
R	89	PICKUP 1 TON, R3500 Standard Cab Pickup	
R	75-86	PICKUP 3/4 TON, C20 Crew Cab Pickup	
R	87-88	PICKUP 3/4 TON, R20 Crew Cab Pickup	
R	89	PICKUP 3/4 TON, R2500 All	
R	74-80	VAN 1/2 TON, P SERIES All	
R	73-99	VAN 1 TON, P SERIES All	
R	79-89	VAN 3/4 TON, P SERIES All	
58944	W		143146
F	07-12	FORD PICKUP, F-450 SUPERDUTY All	
F	10-12	PICKUP, F-550 SUPERDUTY All	
ProGuard			
61500	A		
R	61-66	FORD PICKUP 1 TON, F-350 / SUPERDUTY All	
F	68-76	PICKUP P350 All Up through 8000# GVW	
F	75-76	PICKUP P400 All Up through 8000# GVW	
R	68-72	INTERNATIONAL M1100 / M1200 All	
R	69	M1400 All	
61506	A		141137
F	61-67	FORD ECONOLINE All	
61516	C		
F	81-86	CHEVROLET PICKUP 3/4 TON, K20 All Quad Suspension Short Shock; Exc. Lift Kit	
F	69-80	PICKUP 3/4 TON, K20 All Exc. Lift Kit	
F	87	PICKUP 3/4 TON, V20 All Exc. Quad Suspension and Lift Kit	
F	69-86	GMC PICKUP 3/4 TON, K25 / K2500 All Exc. Quad Suspension and Lift Kit	
F	87	PICKUP 3/4 TON, V2500 All Quad Suspension Short Shock; Exc. Lift Kit	
61517	C		
F	71-95	CHEVROLET VAN 1/2 TON, G / EXPRESS All	
F	70	VAN 1/2 TON, G / EXPRESS All Independent Front Suspension	
F	78-96	VAN 1 TON, G / EXPRESS All	
F	75	VAN 1 TON, G / EXPRESS 146.0 / 370.8 (WheelBase)	
F	71-74	VAN 1 TON, G / EXPRESS All	
F	78-95	VAN 3/4 TON, G / EXPRESS All Exc. 8600# GVW	
F	71-77	VAN 3/4 TON, G / EXPRESS All	

Numerical listing

Shock	POP	Alternative No.	MTG Acc. Supplied
Pos.	Year	Application	
61517 C (cont) 140126			
F	70	VAN 3/4 TON, G / EXPRESS All Independent Front Suspension	
F	71-95	GMC VAN 1/2 TON, G / SAVANA All	
F	70	VAN 1/2 TON, G / SAVANA All Independent Front Suspension	
F	76-95	VAN 1 TON, G / SAVANA All	
F	75	VAN 1 TON, G / SAVANA 110.0 / 279.4 (WheelBase)	
F	75	VAN 1 TON, G / SAVANA 125.0 / 317.5 (WheelBase)	
F	71-74	VAN 1 TON, G / SAVANA All	
F	78-95	VAN 3/4 TON, G / SAVANA All Exc. 8600# GVW	
F	71-77	VAN 3/4 TON, G / SAVANA All	
F	70	VAN 3/4 TON, G / SAVANA All Independent Front Suspension	
61518 C 140126			
R	75-79	FORD PICKUP 1 TON, F-350 / SUPERDUTY Extended Cab Pickup, RWD	
R	67-74	PICKUP 1 TON, F-350 / SUPERDUTY RWD Extended Cab	
61519 A 141137			
R	75-79	FORD PICKUP 1 TON, F-350 / SUPERDUTY Standard Cab Pickup, RWD	
R	73-74	PICKUP 1 TON, F-350 / SUPERDUTY All RWD; Exc. Supercab	
R	69-74	VAN 1 TON, ECONOLINE / CLUB WAGON / SUPERDUTY All	
R	69-74	VAN 3/4 TON, ECONOLINE / CLUB WAGON / SUPERDUTY All	
61520 A 140780			
F	97	FORD F-250 HD RWD	
F	80-97	PICKUP 1 TON, F-350 / SUPERDUTY RWD	
61521 B 140780			
F	67-79	FORD PICKUP 1 TON, F-350 / SUPERDUTY RWD Quad Suspension Rearward of Front Axle	
F	75-91	VAN 1 TON, ECONOLINE / CLUB WAGON / SUPERDUTY All	
F	75-91	VAN 3/4 TON, ECONOLINE / CLUB WAGON / SUPERDUTY All	
61522 A			
F	81-86	CHEVROLET PICKUP 3/4 TON, K20 All Quad Suspension Long Shock; Exc. Lift Kit	
F	87	PICKUP 3/4 TON, V20 All Quad Suspension Long Shock; Exc. Lift Kit	
R	78-95	VAN 1/2 TON, G / EXPRESS All	
R	78-95	VAN 1 TON, G / EXPRESS Cutaway Van	
R	78-95	VAN 3/4 TON, G / EXPRESS All Exc. 8600# GVW	
R	99-03	DODGE VAN 1/2 TON, A / B SERIES / RAM 109.3 / 277.6 (WheelBase) Exc. 7000# GVW	
R	81-98	VAN 1/2 TON, A / B SERIES / RAM 109.6 / 278.4 (WheelBase) Exc. 7000# GVW	
R	71-80	VAN 1/2 TON, A / B SERIES / RAM All	
R	71-03	VAN 1 TON, A / B SERIES / RAM All	
R	71-03	VAN 3/4 TON, A / B SERIES / RAM All	
R	74-80	VAN, CB300 All	
F	81-86	GMC PICKUP 3/4 TON, K25 / K2500 All Quad Suspension Long Shock; Exc. Lift Kit	
F	87	PICKUP 3/4 TON, V2500 All Quad Suspension Long Shock; Exc. Lift Kit	
R	78-95	VAN 1/2 TON, G / SAVANA All	
R	85-96	VAN 1 TON, G / SAVANA Extended Cargo Van	
R	85-96	VAN 1 TON, G / SAVANA Extended Passenger Van	
R	79-96	VAN 1 TON, G / SAVANA Standard Cargo Van	
R	79-96	VAN 1 TON, G / SAVANA Standard Passenger Van	
R	78	VAN 1 TON, G / SAVANA Cutaway Van	
R	78-95	VAN 3/4 TON, G / SAVANA All Exc. 8600# GVW	
R	81-83	PLYMOUTH VAN 1/2 TON, PB SERIES All	
R	74-83	VAN 1 TON, PB SERIES All	
R	74-83	VAN 3/4 TON, PB SERIES All	

ProGuard

Shock	POP	Alternative No.	MTG Acc. Supplied
Pos.	Year	Application	
61523 B 140126			
F	72-93	DODGE PICKUP 3/4 TON, D200 SERIES All Exc. Heavy Duty Package	
F	99-03	VAN 1/2 TON, A / B SERIES / RAM 109.3 / 277.6 (WheelBase) Exc. 7000# GVW	
F	81-98	VAN 1/2 TON, A / B SERIES / RAM 109.6 / 278.4 (WheelBase) Exc. 7000# GVW	
F	71-80	VAN 1/2 TON, A / B SERIES / RAM All	
F	95-03	VAN 1 TON, A / B SERIES / RAM All	
F	71-94	VAN 1 TON, A / B SERIES / RAM All Exc. 4000# Front Axle	
F	71-03	VAN 3/4 TON, A / B SERIES / RAM All	
F	74-80	VAN, CB300 All Exc. 4000# Front Axle	
F	81-83	PLYMOUTH VAN 1/2 TON, PB SERIES All	
F	74-83	VAN 1 TON, PB SERIES All Exc. 4000# Front Axle	
F	74-83	VAN 3/4 TON, PB SERIES All	
61524 B 140357			
R	75-86	CHEVROLET PICKUP 3/4 TON, C20 Standard Cab Pickup	
R	73-74	PICKUP 3/4 TON, C20 All Standard Cab Pickup	
R	73-86	PICKUP 3/4 TON, K20 All Exc. Lift Kit	
R	87	PICKUP 3/4 TON, R20 Standard Cab Pickup	
R	87	PICKUP 3/4 TON, V20 All Exc. Quad Suspension and Lift Kit	
R	73	VAN 1/2 TON, P SERIES All	
R	73-78	VAN 3/4 TON, P SERIES All	
R	75-86	GMC PICKUP 3/4 TON, C25 / C2500 Cab & Chassis	
R	75-86	PICKUP 3/4 TON, C25 / C2500 Standard Cab Pickup	
R	73-74	PICKUP 3/4 TON, C25 / C2500 All Exc. Crew Cab & Bonus Cab	
R	73-86	PICKUP 3/4 TON, K25 / K2500 All Exc. Lift Kit	
R	88-89	PICKUP 3/4 TON, R2500 All Exc. Crew Cab & Bonus Cab	
R	87	PICKUP 3/4 TON, R2500 Cab & Chassis Exc. Crew Cab & Bonus Cab	
R	87	PICKUP 3/4 TON, R2500 Standard Cab Pickup Exc. Crew Cab & Bonus Cab	
R	87	PICKUP 3/4 TON, V2500 All Exc. Lift Kit	
R	73	VAN 1/2 TON, P SERIES All	
R	73-78	VAN 3/4 TON, P SERIES All	
61525 A 140702			
F	63-86	CHEVROLET PICKUP 1 TON, C30 All	
F	88-91	PICKUP 1 TON, C35/3500 Cab & Chassis Exc. HD Solid Front Axle	
F	87-88	PICKUP 1 TON, R30 All	
F	89	PICKUP 1 TON, R3500 Standard Cab Pickup	
F	63-86	PICKUP 3/4 TON, C20 All	
F	87-88	PICKUP 3/4 TON, R20 All	
F	89	PICKUP 3/4 TON, R2500 All	
F	63-80	VAN 1/2 TON, P SERIES All	
F	68-90	VAN 1 TON, P SERIES All Cutaway Chassis	
F	68-89	VAN 3/4 TON, P SERIES All	
F	88-91	GMC PICKUP 1 TON, C35/3500 Cab & Chassis Exc. I Beam Front Axle	
F	67-78	PICKUP 1 TON, C35/3500 All	
F	87-91	PICKUP 1 TON, R3500 All	
F	85-86	PICKUP 3/4 TON, C25 / C2500 Crew Cab Pickup	
F	75-86	PICKUP 3/4 TON, C25 / C2500 Cab & Chassis	
F	75-86	PICKUP 3/4 TON, C25 / C2500 Standard Cab Pickup	
F	75-83	PICKUP 3/4 TON, C25 / C2500 Crew Cab Pickup	
F	67-74	PICKUP 3/4 TON, C25 / C2500 All	
F	87-89	PICKUP 3/4 TON, R2500 All Exc. Crew Cab & Bonus Cab	
F	66	PICKUP 2500 SERIES All	
F	67-80	VAN 1/2 TON, P SERIES All	
F	75-90	VAN 1 TON, P SERIES All Cutaway Chassis	

Numerical listing

Shock	POP	Alternative No.	MTG Acc. Supplied
Pos.	Year	Application	
61525 A (cont) 140702			
F	73-74	VAN 1 TON, P SERIES Base Cutaway Chassis	
F	68-72	VAN 1 TON, P SERIES All	
F	68-89	VAN 3/4 TON, P SERIES All	
F	63-65	VAN, PB 1000 SERIES All	
61530 A			
R	97	FORD F-250 HD 4WD	
R	86-97	PICKUP 1 TON, F-350 / SUPERDUTY 4WD Dual Rear Wheels	
R	82-85	PICKUP 1 TON, F-350 / SUPERDUTY 4WD Clevis Type Lower Front Mount; Exc. Dual Rear Wheels or Lift Kit	
R	80-81	PICKUP 1 TON, F-350 / SUPERDUTY 4WD	
61542 A			
F	88-00	CHEVROLET PICKUP 1 TON, K35 / K3500 All	
F	88-00	PICKUP 3/4 TON, K25 / K2500 All	
F	88-00	GMC PICKUP 1 TON, K35 / K3500 All	
F	88-00	PICKUP 3/4 TON, K25 / K2500 All	
61543 A			
R	91-02	CHEVROLET C3500HD All Solid Front Axle	
R	88-90	PICKUP 1 TON, C35/3500 Extended Cab Pickup Exc. HD Straight Front Axle	
R	88-90	PICKUP 1 TON, C35/3500 Standard Cab Pickup Exc. HD Straight Front Axle	
R	88-00	PICKUP 1 TON, K35 / K3500 All	
R	88-00	PICKUP 3/4 TON, C25 / C2500 All	
R	88-00	PICKUP 3/4 TON, K25 / K2500 All	
R	01-02	GMC C3500HD All	
R	91-00	C3500HD All Solid Front Axle	
R	91-00	PICKUP 1 TON, C35/3500 All Exc. I Beam Front Axle	
R	88-90	PICKUP 1 TON, C35/3500 All Exc. HD Straight Front Axle	
R	88-00	PICKUP 1 TON, K35 / K3500 All	
R	88-00	PICKUP 3/4 TON, C25 / C2500 All	
R	88-00	PICKUP 3/4 TON, K25 / K2500 All	
61544 A 141277			
F	92-00	CHEVROLET PICKUP 1 TON, C35/3500 Crew Cab Pickup Exc. HD Straight Front Axle	
F	88-00	PICKUP 1 TON, C35/3500 Extended Cab Pickup Exc. HD Straight Front Axle	
F	88-00	PICKUP 1 TON, C35/3500 Standard Cab Pickup Exc. HD Straight Front Axle	
F	88-00	PICKUP 3/4 TON, C25 / C2500 All	
F	92-00	GMC PICKUP 1 TON, C35/3500 Crew Cab Pickup Exc. HD Straight Front Axle	
F	88-00	PICKUP 1 TON, C35/3500 Extended Cab Pickup Exc. HD Straight Front Axle	
F	88-00	PICKUP 1 TON, C35/3500 Standard Cab Pickup Exc. HD Straight Front Axle	
F	88-00	PICKUP 3/4 TON, C25 / C2500 All	
61546 C 141047			
F	80-81	FORD PICKUP 1 TON, F-350 / SUPERDUTY 4WD	
61547 A			
R	97	FORD F-250 HD RWD	
R	80-97	PICKUP 1 TON, F-350 / SUPERDUTY RWD Exc. Dual Rear Wheels	
61554 C			
R	80-97	FORD PICKUP 1 TON, F-350 / SUPERDUTY RWD Dual Rear Wheels	
R	97	PICKUP, F-450 SUPERDUTY All	
61555 B 140780			
F	96-02	CHEVROLET VAN 1 TON, G / EXPRESS All	
F	96-02	VAN 3/4 TON, G / EXPRESS All Exc. 8600# GVW	
F	96-02	GMC VAN 1/2 TON, G / SAVANA All	
F	96-02	VAN 1 TON, G / SAVANA All	
F	96-02	VAN 3/4 TON, G / SAVANA All Exc. 8600# GVW	

Numerical listing

Shock	POP	Alternative No.	MTG Acc. Supplied
Pos.	Year	Application	
61565 C			
R	97-02	CHEVROLET VAN 1 TON, G / EXPRESS All	
R	96	VAN 1 TON, G / EXPRESS All Exc. 8600# GVW	
R	96-02	VAN 3/4 TON, G / EXPRESS All Exc. 8600# GVW	
R	03-11	GMC VAN 1/2 TON, G / SAVANA All Exc. Upfitter Package and Cutaway Chassis	
R	96-02	VAN 1/2 TON, G / SAVANA All	
R	96-02	VAN 1 TON, G / SAVANA All Exc. 8600# GVW	
R	96-02	VAN 3/4 TON, G / SAVANA All Exc. 8600# GVW	
61591 D 140780			
F	02-14	FORD VAN 1/2 TON, ECONOLINE / CLUB WAGON All	
F	92-11	VAN 1 TON, ECONOLINE / CLUB WAGON / SUPERDUTY All	
F	92-02	VAN 3/4 TON, ECONOLINE / CLUB WAGON / SUPERDUTY All	
61592 W 142389			
R	49-52	CHEVROLET FLEETLINE All	
R	49-52	FLEETLINE TRUCK All	
61599 B 143000			
F	94-02	DODGE PICKUP 1 TON, RAM 3500 (SEE RAM 3500) RWD Exc. Solid Front Axle	
F	94-02	PICKUP 3/4 TON, RAM 2500 (SEE RAM 2500) RWD	
61600 A			
R	94-02	DODGE PICKUP 1 TON, RAM 3500 (SEE RAM 3500) RWD Exc. Solid Front Axle	
R	94-03	PICKUP 3/4 TON, RAM 2500 (SEE RAM 2500) All Exc. 8800# GVW	
61614 D			
F	97	FORD F-250 HD 4WD	
F	86-97	PICKUP 1 TON, F-350 / SUPERDUTY 4WD	
61632 W			
F	81-93	DODGE PICKUP 1 TON, W300 SERIES All Exc. Quad Suspension and Lift Kit	
F	61-80	PICKUP 1 TON, W300 SERIES All	
R	61-71	PICKUP 1 TON, W300 SERIES All	
F	90-93	PICKUP 3/4 TON, W200 SERIES Extended Cab Pickup Exc. Lift Kit	
F	88-93	PICKUP 3/4 TON, W200 SERIES Cab & Chassis Exc. Lift Kit	
F	81-93	PICKUP 3/4 TON, W200 SERIES Standard Cab Pickup Exc. Lift Kit	
F	86	PICKUP 3/4 TON, W200 SERIES Cab & Chassis Exc. Lift Kit	
F	81-83	PICKUP 3/4 TON, W200 SERIES Cab & Chassis Exc. Lift Kit	
F	81-82	PICKUP 3/4 TON, W200 SERIES Extended Cab Pickup Exc. Lift Kit	
F	69-80	PICKUP 3/4 TON, W200 SERIES All	
F	61-67	PICKUP 3/4 TON, W200 SERIES All	
61634 W 142731			
F	94-02	DODGE PICKUP 3/4 TON, RAM 2500 (SEE RAM 2500) 4WD Exc. 8800# GVW	
61635 C 142731			
F	94-02	DODGE PICKUP 1 TON, RAM 3500 (SEE RAM 3500) 4WD	
F	94-02	PICKUP 1 TON, RAM 3500 (SEE RAM 3500) RWD Solid Front Axle	
F	94-02	PICKUP 3/4 TON, RAM 2500 (SEE RAM 2500) 4WD 8800# GVW	
61641 A 141665			
F	99-04	CHEVROLET PICKUP 3/4 TON, SILVERADO 2500 RWD Exc. Electronic Adjustable Suspension	
F	99-04	GMC SIERRA 2500 RWD Exc. Electronic Adjustable Suspension	
61642 A			
R	77-86	CHEVROLET PICKUP 1 TON, K30 All	
R	90-91	PICKUP 1 TON, R3500 All	
R	89	PICKUP 1 TON, R3500 Cab & Chassis, RWD	
R	89	PICKUP 1 TON, R3500 Crew Cab Pickup, RWD	

ProGuard, Max Control

Shock	POP	Alternative No.	MTG Acc. Supplied
Pos.	Year	Application	
61642 A (cont)			
R	01-09	PICKUP 1 TON, SILVERADO 3500 All	
R	07-10	PICKUP 1 TON, SILVERADO 3500 HD All	
R	87-88	PICKUP 1 TON, V30 All	
R	89-91	PICKUP 1 TON, V3000 / V3500 All	
R	99-08	PICKUP 3/4 TON, SILVERADO 2500 All	
R	01-10	PICKUP 3/4 TON, SILVERADO 2500 HD All	
R	07	SILVERADO 2500 HD CLASSIC All	
R	94-02	DODGE PICKUP 1 TON, RAM 3500 (SEE RAM 3500) 4WD	
R	94-02	PICKUP 1 TON, RAM 3500 (SEE RAM 3500) RWD Solid Front Axle	
R	94-02	PICKUP 3/4 TON, RAM 2500 (SEE RAM 2500) 4WD 8800# GVW	
R	77-86	GMC PICKUP 1 TON, K35 / K3500 All	
R	87-91	PICKUP 1 TON, V3000 / V3500 All	
R	99-04	SIERRA 2500 All	
R	01-10	SIERRA 2500 HD All	
R	01-06	SIERRA 3500 All	
R	07	SIERRA 3500 CLASSIC All	
R	07-10	SIERRA 3500 HD All	
61646 W 142617			
R	00-02	FORD E-450 ECONOLINE SUPER DUTY All	
R	00-06	ECONOLINE All	
R	21-26	VAN 1 TON, ECONOLINE / CLUB WAGON / SUPERDUTY All	
R	92-19	VAN 1 TON, ECONOLINE / CLUB WAGON / SUPERDUTY All	
R	04-11	VAN 1 TON, ECONOLINE / CLUB WAGON / SUPERDUTY All Exc. Cutaway Chassis	
R	92-14	VAN 3/4 TON, ECONOLINE / CLUB WAGON / SUPERDUTY All	
61654 W			
R	99-04	FORD PICKUP 1 TON, F-350 / SUPERDUTY RWD	
R	99-04	PICKUP 3/4 TON, F-250 / SUPERDUTY RWD	
61655 B			
R	02	FORD E-550 ECONOLINE SUPER DUTY All	
R	03	E-550 SUPER DUTY All	
F	99-04	PICKUP 1 TON, F-350 / SUPERDUTY 4WD	
F	99-04	PICKUP 3/4 TON, F-250 / SUPERDUTY 4WD	
F	99-04	PICKUP, F-450 SUPERDUTY All	
F	99-04	PICKUP, F-550 SUPERDUTY All	
61656 C			
R	99-04	FORD PICKUP 1 TON, F-350 / SUPERDUTY 4WD	
R	99-04	PICKUP 3/4 TON, F-250 / SUPERDUTY 4WD	
61663 A 141665			
F	01-09	CHEVROLET PICKUP 1 TON, SILVERADO 3500 All	
F	07-10	PICKUP 1 TON, SILVERADO 3500 HD All	
F	05-08	PICKUP 3/4 TON, SILVERADO 2500 All	
F	99-04	PICKUP 3/4 TON, SILVERADO 2500 4WD	
F	01-10	PICKUP 3/4 TON, SILVERADO 2500 HD All 9200# GVW	
F	07	SILVERADO 2500 HD CLASSIC All	
F	99-04	GMC SIERRA 2500 4WD	
F	05-10	SIERRA 2500 HD 4WD	
F	01-04	SIERRA 2500 HD All	
F	01-06	SIERRA 3500 All	
F	07	SIERRA 3500 CLASSIC All	
F	07-10	SIERRA 3500 HD Torsion Bar (FrontSpringType)	
61680 A 142731			
F	05-24	FORD PICKUP 1 TON, F-350 / SUPERDUTY 4WD	
F	11-16	PICKUP 1 TON, F-350 / SUPERDUTY All	
F	99-09	PICKUP 1 TON, F-350 / SUPERDUTY All	
F	05-24	PICKUP 3/4 TON, F-250 / SUPERDUTY 4WD	

Numerical listing

Shock	POP	Alternative No.	MTG Acc. Supplied
Pos.	Year	Application	
61682 B			
R	13-16	FORD PICKUP 1 TON, F-350 / SUPERDUTY 4WD w/ Off Road Package	
R	05-12	PICKUP 1 TON, F-350 / SUPERDUTY Crew Cab Pickup, 4WD Single Rear Wheels	
R	05-12	PICKUP 1 TON, F-350 / SUPERDUTY Extended Cab Pickup, 4WD Single Rear Wheels	
R	05-12	PICKUP 1 TON, F-350 / SUPERDUTY Standard Cab Pickup, 4WD Single Rear Wheels	
R	12-16	PICKUP 3/4 TON, F-250 / SUPERDUTY RWD w/ Off Road Package	
R	05-16	PICKUP 3/4 TON, F-250 / SUPERDUTY 4WD	
61683 W 143276			
F	06-09	CHEVROLET VAN 3/4 TON, G / EXPRESS All Torsion Bar (FrontSpringType)	
F	03-05	VAN 3/4 TON, G / EXPRESS Torsion Bar (FrontSpringType)	
F	10-14	GMC VAN 1/2 TON, G / SAVANA AWD, Torsion Bar (FrontSpringType)	
F	04-09	VAN 1/2 TON, G / SAVANA Torsion Bar (FrontSpringType)	
F	03	VAN 1/2 TON, G / SAVANA Torsion Bar (FrontSpringType) Torsion Bar (FrontSpringType)	
F	06-09	VAN 3/4 TON, G / SAVANA All Torsion Bar (FrontSpringType)	
F	03-05	VAN 3/4 TON, G / SAVANA AWD, Torsion Bar (FrontSpringType)	
61684 D 143276			
F	03-14	GMC VAN 1/2 TON, G / SAVANA RWD, Coil (FrontSpringType)	
61685 A 143276			
F	09-22	CHEVROLET EXPRESS 4500 All	
F	10-24	VAN 1 TON, G / EXPRESS All	
F	10-24	VAN 3/4 TON, G / EXPRESS All	
F	10-20	GMC SAVANA 4500 All	
F	10-24	VAN 1 TON, G / SAVANA All	
F	10-24	VAN 3/4 TON, G / SAVANA All	
61687 A			
R	09-22	CHEVROLET EXPRESS 4500 All	
R	25	VAN 1 TON, G / EXPRESS All	
R	13-23	VAN 1 TON, G / EXPRESS All	
R	03-12	VAN 1 TON, G / EXPRESS All Single Rear Wheels	
R	03-24	VAN 3/4 TON, G / EXPRESS All	
R	10-20	GMC SAVANA 4500 All	
R	25	VAN 1 TON, G / SAVANA All	
R	13-23	VAN 1 TON, G / SAVANA All	
R	03-12	VAN 1 TON, G / SAVANA All Single Rear Wheels	
R	25	VAN 3/4 TON, G / SAVANA All	
R	03-23	VAN 3/4 TON, G / SAVANA All	
61710 W			
R	03-07	DODGE PICKUP 1 TON, RAM 3500 (SEE RAM 3500) Crew Cab Pickup, RWD	
R	03-10	PICKUP 3/4 TON, RAM 2500 (SEE RAM 2500) Crew Cab Pickup, RWD	
61713 D			
R	05-16	FORD PICKUP 1 TON, F-350 / SUPERDUTY RWD Exc. Off Road Package	
R	05-16	PICKUP 3/4 TON, F-250 / SUPERDUTY RWD Exc. Off Road Package	
61714 D 142731			
F	04-10	DODGE PICKUP 3/4 TON, RAM 2500 (SEE RAM 2500) 4WD	
61716 C			
R	03-10	DODGE PICKUP 3/4 TON, RAM 2500 (SEE RAM 2500) 4WD	
R	11-13	RAM 2500 (SEE DODGE RAM 2500) 4WD	
Max Control			
77375 C 140780			
F	96-02	CHEVROLET VAN 1 TON, G / EXPRESS All	
F	96-02	VAN 3/4 TON, G / EXPRESS All Exc. 8600# GVW	

Numerical listing

Shock	POP	Alternative No.	MTG Acc. Supplied
Pos.	Year	Application	
77375	C (cont)	140780	
F	96-02	GMC VAN 1/2 TON, G / SAVANA RWD	
F	96-02	VAN 1 TON, G / SAVANA All	
F	96-02	VAN 3/4 TON, G / SAVANA All Exc. 8600# GVW	
77403	D		
R	79-95	CHEVROLET VAN 1 TON, G / EXPRESS All 9200# GVW	
F	85	VAN 1 TON, P SERIES All Motorhome Chassis w/ I-Beam Front Suspension	
R	79-95	GMC VAN 1 TON, G / SAVANA Cutaway Van 9200# GVW	
F	85	VAN 1 TON, P SERIES All Motorhome Chassis w/ I-Beam Front Suspension	
77412	A		
R	77-86	CHEVROLET PICKUP 1 TON, K30 All	
R	90-91	PICKUP 1 TON, R3500 All	
R	89	PICKUP 1 TON, R3500 Cab & Chassis, RWD	
R	89	PICKUP 1 TON, R3500 Crew Cab Pickup, RWD	
R	01-09	PICKUP 1 TON, SILVERADO 3500 All	
R	08-10	PICKUP 1 TON, SILVERADO 3500 HD All	
R	07	PICKUP 1 TON, SILVERADO 3500 HD All Classic	
R	87-88	PICKUP 1 TON, V30 All	
R	89-91	PICKUP 1 TON, V3000 / V3500 All	
R	99-08	PICKUP 3/4 TON, SILVERADO 2500 All	
R	01-10	PICKUP 3/4 TON, SILVERADO 2500 HD All	
R	07	SILVERADO 2500 HD CLASSIC All	
R	77-86	GMC PICKUP 1 TON, K35 / K3500 All	
R	87-91	PICKUP 1 TON, V3000 / V3500 All	
R	99-04	SIERRA 2500 All	
R	01-10	SIERRA 2500 HD All	
R	07	SIERRA 2500 HD CLASSIC 4WD	
R	01-06	SIERRA 3500 All	
R	07	SIERRA 3500 CLASSIC All	
R	07-10	SIERRA 3500 HD All	
77414	C	140780	
F	97	FORD F-250 HD 4WD Quad Suspension; Rearward of Front Axle	
F	80-97	PICKUP 1 TON, F-350 / SUPERDUTY RWD Quad Suspension; Rearward of Front Axle	
77455	C		
F	86-97	FORD PICKUP 1 TON, F-350 / SUPERDUTY 4WD	
77461	B		
R	97	FORD F-250 HD 4WD	
R	86-97	PICKUP 1 TON, F-350 / SUPERDUTY 4WD Dual Rear Wheels	
R	82-85	PICKUP 1 TON, F-350 / SUPERDUTY 4WD Clevis Type Lower Front Mount; Exc. Dual Rear Wheels or Lift Kit	
R	80-81	PICKUP 1 TON, F-350 / SUPERDUTY 4WD	
R	99-04	PICKUP, F-450 SUPERDUTY All	
R	99-04	PICKUP, F-550 SUPERDUTY All	
77488	B		
R	91-00	CHEVROLET PICKUP 1 TON, C35/3500 All	
R	89-90	PICKUP 1 TON, C35/3500 Extended Cab Pickup	
R	89-90	PICKUP 1 TON, C35/3500 Standard Cab Pickup	
R	88	PICKUP 1 TON, C35/3500 Extended Cab Pickup Exc. HD Straight Front Axle	
R	88	PICKUP 1 TON, C35/3500 Standard Cab Pickup Exc. HD Straight Front Axle	
R	88-00	PICKUP 1 TON, K35 / K3500 All	
R	88-00	PICKUP 3/4 TON, C25 / C2500 All	
R	88-00	PICKUP 3/4 TON, K25 / K2500 All	
R	91-00	GMC PICKUP 1 TON, C35/3500 All	
R	88-90	PICKUP 1 TON, C35/3500 Extended Cab Pickup Exc. HD Straight Front Axle	

Max Control

Shock	POP	Alternative No.	MTG Acc. Supplied
Pos.	Year	Application	
77488	B (cont)		
R	88-90	PICKUP 1 TON, C35/3500 Standard Cab Pickup Exc. HD Straight Front Axle	
R	88-00	PICKUP 1 TON, K35 / K3500 All	
R	88-00	PICKUP 3/4 TON, C25 / C2500 All	
R	88-00	PICKUP 3/4 TON, K25 / K2500 All	
77489	C	141277	
F	98-00	CHEVROLET PICKUP 1 TON, C35/3500 All Exc. HD Straight Front Axle	
F	92-97	PICKUP 1 TON, C35/3500 Crew Cab Pickup Exc. HD Straight Front Axle	
F	88-97	PICKUP 1 TON, C35/3500 Extended Cab Pickup Exc. HD Straight Front Axle	
F	88-97	PICKUP 1 TON, C35/3500 Standard Cab Pickup Exc. HD Straight Front Axle	
F	88-00	PICKUP 3/4 TON, C25 / C2500 All	
F	92-00	GMC PICKUP 1 TON, C35/3500 Crew Cab Pickup Exc. HD Straight Front Axle	
F	88-00	PICKUP 1 TON, C35/3500 Extended Cab Pickup Exc. HD Straight Front Axle	
F	88-00	PICKUP 1 TON, C35/3500 Standard Cab Pickup Exc. HD Straight Front Axle	
F	88-00	PICKUP 3/4 TON, C25 / C2500 All	
77607	W	140719	
R	00-05	FORD EXCURSION RWD	
77608	W	140780	
F	02-14	FORD VAN 1/2 TON, ECONOLINE / CLUB WAGON All	
77609	A		
F	88-00	CHEVROLET PICKUP 1 TON, K35 / K3500 All	
F	88-00	PICKUP 3/4 TON, K25 / K2500 All	
F	88-00	GMC PICKUP 1 TON, K35 / K3500 All	
F	88-00	PICKUP 3/4 TON, K25 / K2500 All	
77614	A	140780	
F	00-02	FORD E-450 ECONOLINE SUPER DUTY All	
F	96-99	ECONOLINE SUPER DUTY All	
F	00-05	EXCURSION RWD	
F	21-26	VAN 1 TON, ECONOLINE / CLUB WAGON / SUPERDUTY All	
F	07-19	VAN 1 TON, ECONOLINE / CLUB WAGON / SUPERDUTY All Exc. Cutaway Chassis	
F	99-19	VAN 1 TON, ECONOLINE / CLUB WAGON / SUPERDUTY All	
F	92-05	VAN 1 TON, ECONOLINE / CLUB WAGON / SUPERDUTY All Cutaway Chassis	
F	92-14	VAN 3/4 TON, ECONOLINE / CLUB WAGON / SUPERDUTY All	
77623	D	142731	
R	00-02	FORD E-450 ECONOLINE SUPER DUTY All Exc. Cutaway Chassis	
R	96-99	ECONOLINE SUPER DUTY All	
R	21-26	VAN 1 TON, ECONOLINE / CLUB WAGON / SUPERDUTY All	
R	03-19	VAN 1 TON, ECONOLINE / CLUB WAGON / SUPERDUTY All Exc. Cutaway Chassis	
R	07-08	VAN 1 TON, ECONOLINE / CLUB WAGON / SUPERDUTY All	
R	92-05	VAN 1 TON, ECONOLINE / CLUB WAGON / SUPERDUTY All Cutaway Chassis	
R	99-03	VAN 1 TON, ECONOLINE / CLUB WAGON / SUPERDUTY All	
R	92-14	VAN 3/4 TON, ECONOLINE / CLUB WAGON / SUPERDUTY All	
77638	A		
R	09-22	CHEVROLET EXPRESS 4500 All	
R	03-24	VAN 1 TON, G / EXPRESS All	
R	03-24	VAN 3/4 TON, G / EXPRESS All	
R	96-02	VAN 3/4 TON, G / EXPRESS All Exc. 8600# GVW	
R	10-20	GMC SAVANA 4500 All	
R	96-14	VAN 1/2 TON, G / SAVANA RWD	
R	04-24	VAN 1 TON, G / SAVANA All	
R	96-02	VAN 1 TON, G / SAVANA All Exc. 8600# GVW	

Numerical listing

Shock	POP	Alternative No.	MTG Acc. Supplied
Pos.	Year	Application	
77638	A (cont)		
R	96	VAN 1 TON, G / SAVANA All 7100, 7400 and 8600# GVW	
R	03-24	VAN 3/4 TON, G / SAVANA All	
R	96-02	VAN 3/4 TON, G / SAVANA All Exc. 8600# GVW	
77661	D	143000	
F	94-02	DODGE PICKUP 1 TON, RAM 3500 (SEE RAM 3500) RWD Exc. Solid Front Axle	
F	94-02	PICKUP 3/4 TON, RAM 2500 (SEE RAM 2500) RWD	
77662	C		
R	74-80	CHEVROLET VAN 1/2 TON, P SERIES All	
R	79-89	VAN 3/4 TON, P SERIES All	
R	94-02	DODGE PICKUP 1 TON, RAM 3500 (SEE RAM 3500) RWD Exc. Solid Front Axle	
R	94-02	PICKUP 3/4 TON, RAM 2500 (SEE RAM 2500) All Exc. 8800# GVW	
R	74-80	GMC VAN 1/2 TON, P SERIES All	
R	75-99	VAN 1 TON, P SERIES All	
R	73-74	VAN 1 TON, P SERIES Base Cutaway Chassis	
R	74	VAN 1 TON, P SERIES Motorhome	
77673	W	142731	
F	94-02	DODGE PICKUP 3/4 TON, RAM 2500 (SEE RAM 2500) 4WD Exc. 8800# GVW	
77674	D	142731	
F	94-02	DODGE PICKUP 1 TON, RAM 3500 (SEE RAM 3500) 4WD	
F	94-02	PICKUP 1 TON, RAM 3500 (SEE RAM 3500) RWD Solid Front Axle	
F	94-02	PICKUP 3/4 TON, RAM 2500 (SEE RAM 2500) 4WD 8800# GVW	
77675	D		
R	94-02	DODGE PICKUP 1 TON, RAM 3500 (SEE RAM 3500) 4WD	
R	94-02	PICKUP 1 TON, RAM 3500 (SEE RAM 3500) RWD Solid Front Axle	
R	94-02	PICKUP 3/4 TON, RAM 2500 (SEE RAM 2500) 4WD 8800# GVW	
77716	A	142731	
F	75-91	FORD VAN 1/2 TON, ECONOLINE / CLUB WAGON All	
77783	C	141665	
F	99-04	CHEVROLET PICKUP 3/4 TON, SILVERADO 2500 RWD Exc. Electronic Adjustable Suspension	
F	99-04	GMC SIERRA 2500 RWD Exc. Electronic Adjustable Suspension	
77807	C	143078	
F	99-24	FORD PICKUP 1 TON, F-350 / SUPERDUTY RWD	
F	11-16	PICKUP 1 TON, F-350 / SUPERDUTY All	
F	99-09	PICKUP 1 TON, F-350 / SUPERDUTY All	
F	99-24	PICKUP 3/4 TON, F-250 / SUPERDUTY RWD	
77808	W		
R	99-04	FORD PICKUP 1 TON, F-350 / SUPERDUTY RWD	
R	99-04	PICKUP 3/4 TON, F-250 / SUPERDUTY RWD	
77809	A		
F	00-05	FORD EXCURSION 4WD	
R	97	F-250 HD RWD	
F	99-04	PICKUP 1 TON, F-350 / SUPERDUTY 4WD	
R	80-97	PICKUP 1 TON, F-350 / SUPERDUTY RWD Exc. Dual Rear Wheels	
F	99-04	PICKUP 3/4 TON, F-250 / SUPERDUTY 4WD	
F	99-04	PICKUP, F-450 SUPERDUTY All	
F	99-04	PICKUP, F-550 SUPERDUTY All	
77810	A		
R	99-04	FORD PICKUP 1 TON, F-350 / SUPERDUTY 4WD	
R	99-04	PICKUP 3/4 TON, F-250 / SUPERDUTY 4WD	

Numerical listing

Shock	POP	Alternative No.	MTG Acc. Supplied
Pos.	Year	Application	
77817	A		141665
F	01-09	CHEVROLET PICKUP 1 TON, SILVERADO 3500 All	
F	07-10	PICKUP 1 TON, SILVERADO 3500 HD All	
F	05-08	PICKUP 3/4 TON, SILVERADO 2500 All	
F	99-04	PICKUP 3/4 TON, SILVERADO 2500 4WD	
F	01-10	PICKUP 3/4 TON, SILVERADO 2500 HD All 9200# GVW	
F	07	SILVERADO 2500 HD CLASSIC All	
F	99-04	GMC SIERRA 2500 4WD	
F	01-10	SIERRA 2500 HD 4WD	
F	01-06	SIERRA 3500 All	
F	07-10	SIERRA 3500 HD Torsion Bar (FrontSpringType)	
77837	W		
R	00-05	FORD EXCURSION 4WD	
77907	W		
F	68-76	FORD PICKUP P350 All Up through 8000# GVW	
F	75-76	PICKUP P400 All Up through 8000# GVW	
R	96-04	MITSUBISHI FUSO FE All Model with O.E.M Number	
R	98-04	FG All Model with O.E.M Number	
77948	B		142731
F	07-10	DODGE PICKUP 1 TON, RAM 3500 (SEE RAM 3500) 4WD	
F	06	PICKUP 1 TON, RAM 3500 (SEE RAM 3500) 4WD Exc. 5.9L	
F	03-05	PICKUP 1 TON, RAM 3500 (SEE RAM 3500) 4WD	
F	07-10	PICKUP 3/4 TON, RAM 2500 (SEE RAM 2500) 4WD	
F	06	PICKUP 3/4 TON, RAM 2500 (SEE RAM 2500) 4WD, 4.7L 8Cyl V (287), 3.66 93.0(Bore)3.41 86.5(Stroke)	
F	06	PICKUP 3/4 TON, RAM 2500 (SEE RAM 2500) 4WD, 5.9L 6Cyl L (359), 4.02 102.0(Bore)4.72 120.0(Stroke)	
F	03-05	PICKUP 3/4 TON, RAM 2500 (SEE RAM 2500) 4WD	
F	11-24	RAM 2500 (SEE DODGE RAM 2500) 4WD	
F	11-20	3500 (SEE DODGE RAM 3500) 4WD	
77950	A		
R	03-10	DODGE PICKUP 1 TON, RAM 3500 (SEE RAM 3500) All	
R	03-10	PICKUP 3/4 TON, RAM 2500 (SEE RAM 2500) All	
R	11-13	RAM 2500 (SEE DODGE RAM 2500) All	
R	11-13	3500 (SEE DODGE RAM 3500) All	
77951	C		142731
F	05-24	FORD PICKUP 1 TON, F-350 / SUPERDUTY 4WD	
F	11-16	PICKUP 1 TON, F-350 / SUPERDUTY All 4WD	
F	99-09	PICKUP 1 TON, F-350 / SUPERDUTY All 4WD	
F	05-24	PICKUP 3/4 TON, F-250 / SUPERDUTY 4WD	
77952	A		
R	13-16	FORD PICKUP 1 TON, F-350 / SUPERDUTY 4WD	
R	05-12	PICKUP 1 TON, F-350 / SUPERDUTY Crew Cab Pickup, 4WD Single Rear Wheels	
R	05-12	PICKUP 1 TON, F-350 / SUPERDUTY Extended Cab Pickup, 4WD Single Rear Wheels	
R	05-12	PICKUP 1 TON, F-350 / SUPERDUTY Standard Cab Pickup, 4WD Single Rear Wheels	
R	05-16	PICKUP 3/4 TON, F-250 / SUPERDUTY 4WD	
77967	D		143146
F	20-24	FORD F-600 SUPER DUTY All Applications with OEM Number	
F	13-24	PICKUP, F-450 SUPERDUTY All	
F	05-08	PICKUP, F-450 SUPERDUTY All	
F	13-24	PICKUP, F-550 SUPERDUTY All	
F	05-07	PICKUP, F-550 SUPERDUTY All	

Max Control, Guardian Shock

Shock	POP	Alternative No.	MTG Acc. Supplied
Pos.	Year	Application	
77968	W		
R	13-16	FORD PICKUP, F-450 SUPERDUTY 4 X 2	
R	05-07	PICKUP, F-450 SUPERDUTY 4 X 2	
R	13-16	PICKUP, F-550 SUPERDUTY 4 X 2	
R	05-07	PICKUP, F-550 SUPERDUTY 4 X 2	
77969	W		
R	13-16	FORD PICKUP, F-450 SUPERDUTY 4 X 4	
R	05-07	PICKUP, F-450 SUPERDUTY 4 X 4	
R	13-16	PICKUP, F-550 SUPERDUTY 4 X 4	
R	05-07	PICKUP, F-550 SUPERDUTY 4 X 4	
77976	A		
R	11-24	CHEVROLET PICKUP 1 TON, SILVERADO 3500 HD All	
R	11-24	PICKUP 3/4 TON, SILVERADO 2500 HD All	
R	11-24	GMC SIERRA 2500 HD All	
R	11-24	SIERRA 3500 HD All	
R	14-25	RAM 3500 (SEE DODGE RAM 3500) All Coil Spring Suspension	
77980	W		142731
F	06	DODGE PICKUP 1 TON, RAM 3500 (SEE RAM 3500) 4WD, 5.7L 8Cyl V (345), 3.92 99.57(Bore)3.58 90.93(Stroke)	
F	06	PICKUP 3/4 TON, RAM 2500 (SEE RAM 2500) 4WD, 5.7L 8Cyl V (345), 3.92 99.57(Bore)3.58 90.93(Stroke)	
77986	W		
R	24	FORD PICKUP, F-450 SUPERDUTY 4 X 4 Models with 4WD and OEM number	
R	17-23	PICKUP, F-450 SUPERDUTY All Models with 4WD and OEM number	
R	24	PICKUP, F-550 SUPERDUTY 4 X 4 Models with 4WD and OEM number	
R	17-23	PICKUP, F-550 SUPERDUTY All Models with 4WD and OEM number	
77987	W		
R	20-24	FORD F-600 SUPER DUTY 4 X 2 Models with RWD and OEM number	
R	24	PICKUP, F-450 SUPERDUTY RWD Models with RWD and OEM number	
R	17-23	PICKUP, F-450 SUPERDUTY All Models with RWD and OEM number	
R	24	PICKUP, F-550 SUPERDUTY RWD Models with RWD and OEM number	
R	17-23	PICKUP, F-550 SUPERDUTY All Models with RWD and OEM number	
77988	W		
R	17-24	FORD PICKUP 1 TON, F-350 / SUPERDUTY 4WD	
R	17-24	PICKUP 3/4 TON, F-250 / SUPERDUTY 4WD	
Guardian Shock			
81039	A		140357
F	63-86	CHEVROLET PICKUP 1 TON, C30 All	
F	88-91	PICKUP 1 TON, C35/3500 Cab & Chassis Exc. HD Solid Front Axle	
F	87-88	PICKUP 1 TON, R30 All	
F	89-91	PICKUP 1 TON, R3500 All	
F	63-86	PICKUP 3/4 TON, C20 All	
F	87-88	PICKUP 3/4 TON, R20 All	
F	89	PICKUP 3/4 TON, R2500 All	
F	63-80	VAN 1/2 TON, P SERIES All	
F	68-90	VAN 1 TON, P SERIES All Cutaway Chassis	
F	68-89	VAN 3/4 TON, P SERIES All	
F	88-91	GMC PICKUP 1 TON, C35/3500 Cab & Chassis	
F	80-86	PICKUP 1 TON, C35/3500 All	
F	67-78	PICKUP 1 TON, C35/3500 All	
F	87-91	PICKUP 1 TON, R3500 All	
F	83-86	PICKUP 3/4 TON, C25 / C2500 All	
F	75-82	PICKUP 3/4 TON, C25 / C2500 Cab & Chassis	
F	75-82	PICKUP 3/4 TON, C25 / C2500 Crew Cab Pickup	
F	75-82	PICKUP 3/4 TON, C25 / C2500 Standard Cab Pickup	
F	67-74	PICKUP 3/4 TON, C25 / C2500 All	
F	87-89	PICKUP 3/4 TON, R2500 All Exc. Crew Cab & Bonus Cab	
F	66	PICKUP 2500 SERIES All	
F	67-80	VAN 1/2 TON, P SERIES All	

Numerical listing

Shock	POP	Alternative No.	MTG Acc. Supplied
Pos.	Year	Application	
81039	A (cont)		140357
F	75-90	VAN 1 TON, P SERIES All Cutaway Chassis	
F	73-74	VAN 1 TON, P SERIES Base Cutaway Chassis	
F	68-72	VAN 1 TON, P SERIES All	
F	68-89	VAN 3/4 TON, P SERIES All	
F	63-65	VAN, PB 1000 SERIES All	
81082	C		
R	97	FORD F-250 HD RWD	
R	80-97	PICKUP 1 TON, F-350 / SUPERDUTY RWD Exc. Dual Rear Wheels	
81091	B		
R	72-93	DODGE PICKUP 1 TON, D300 SERIES All	
R	72-93	PICKUP 3/4 TON, D200 SERIES All	
81096	C		140126
F	72-93	DODGE PICKUP 3/4 TON, D200 SERIES All Exc. Heavy Duty Package	
F	99-03	VAN 1/2 TON, A / B SERIES / RAM 109.3 / 277.6 (WheelBase) Exc. 7000# GVW	
F	81-98	VAN 1/2 TON, A / B SERIES / RAM 109.6 / 278.4 (WheelBase) Exc. 7000# GVW	
F	71-80	VAN 1/2 TON, A / B SERIES / RAM All	
F	95-03	VAN 1 TON, A / B SERIES / RAM All	
F	71-94	VAN 1 TON, A / B SERIES / RAM All Exc. 4000# Front Axle	
F	71-03	VAN 3/4 TON, A / B SERIES / RAM All	
F	74-80	VAN, CB300 All Exc. 4000# Front Axle	
F	81-83	PLYMOUTH VAN 1/2 TON, PB SERIES All	
F	74-83	VAN 1 TON, PB SERIES All Exc. 4000# Front Axle	
F	74-83	VAN 3/4 TON, PB SERIES All	
81113	D		
F	81-86	CHEVROLET PICKUP 3/4 TON, K20 All Standard Suspension; Exc. Lift Kit	
F	69-80	PICKUP 3/4 TON, K20 All Exc. Lift Kit	
F	69-86	GMC PICKUP 3/4 TON, K25 / K2500 All Exc. Quad Suspension and Lift Kit	
F	87	PICKUP 3/4 TON, V2500 All Quad Suspension Short Shock; Exc. Lift Kit	
81147	B		
F	65-66	FORD PICKUP 1 TON, F-350 / SUPERDUTY All	
R	61-64	PICKUP 1 TON, F-350 / SUPERDUTY All	
F	68-75	PICKUP P350 All Up through 8000# GVW	
F	75-76	PICKUP P400 All Up through 8000# GVW	
R	68-72	INTERNATIONAL M1100 / M1200 All	
R	69	M1400 All	
81164	B		140357
R	75-86	CHEVROLET PICKUP 3/4 TON, C20 Standard Cab Pickup	
R	73-74	PICKUP 3/4 TON, C20 All Standard Cab Pickup	
R	73-86	PICKUP 3/4 TON, K20 All Exc. Lift Kit	
R	87	PICKUP 3/4 TON, R20 Standard Cab Pickup	
R	87	PICKUP 3/4 TON, V20 All Exc. Quad Suspension and Lift Kit	
R	73	VAN 1/2 TON, P SERIES All	
R	73-78	VAN 3/4 TON, P SERIES All	
R	83-86	GMC PICKUP 3/4 TON, C25 / C2500 All	
R	75-82	PICKUP 3/4 TON, C25 / C2500 Cab & Chassis	
R	75-82	PICKUP 3/4 TON, C25 / C2500 Crew Cab Pickup	
R	75-82	PICKUP 3/4 TON, C25 / C2500 Standard Cab Pickup	
R	73-86	PICKUP 3/4 TON, K25 / K2500 All Exc. Lift Kit	
R	88-89	PICKUP 3/4 TON, R2500 All Exc. Crew Cab & Bonus Cab	

Numerical listing

Shock	POP	Alternative No.	MTG Acc. Supplied
Pos.	Year	Application	
81164	B (cont)		140357
R 87	PICKUP 3/4 TON, R2500 Cab & Chassis Exc. Crew Cab & Bonus Cab		
R 87	PICKUP 3/4 TON, R2500 Standard Cab Pickup Exc. Crew Cab & Bonus Cab		
R 87	PICKUP 3/4 TON, V2500 All Exc. Lift Kit		
R 73	VAN 1/2 TON, P SERIES All		
R 73-78	VAN 3/4 TON, P SERIES All		
81242	B		140126
R 75-79	FORD PICKUP 1 TON, F-350 / SUPERDUTY Extended Cab Pickup, RWD		
81270	A		140523
R 60	FORD PICKUP 1 TON, F-350 / SUPERDUTY All		
81318	C		141137
F 61-67	FORD ECONOLINE All		
81340	D		141041
R 49-52	CHEVROLET FLEETLINE All		
R 49-52	FLEETLINE TRUCK All		
81342	D		
R 81-93	DODGE PICKUP 1 TON, W300 SERIES All Exc. Quad Suspension and Lift Kit		
R 72-80	PICKUP 1 TON, W300 SERIES All		
R 90-93	PICKUP 3/4 TON, W200 SERIES Extended Cab Pickup Exc. Lift Kit		
R 88-93	PICKUP 3/4 TON, W200 SERIES Cab & Chassis Exc. Lift Kit		
R 81-93	PICKUP 3/4 TON, W200 SERIES Standard Cab Pickup Exc. Lift Kit		
R 86	PICKUP 3/4 TON, W200 SERIES Cab & Chassis Exc. Lift Kit		
R 81-83	PICKUP 3/4 TON, W200 SERIES Cab & Chassis Exc. Lift Kit		
R 81-82	PICKUP 3/4 TON, W200 SERIES Extended Cab Pickup Exc. Lift Kit		
R 72-80	PICKUP 3/4 TON, W200 SERIES All		
81394	B		140780
F 79	FORD PICKUP 1 TON, F-350 / SUPERDUTY RWD Quad Suspension Rearward of Front Axle		
F 67-78	PICKUP 1 TON, F-350 / SUPERDUTY RWD		
F 75-91	VAN 1 TON, ECONOLINE / CLUB WAGON / SUPERDUTY All		
F 77	VAN 1 TON, ECONOLINE / CLUB WAGON / SUPERDUTY All Exc. Cutaway Chassis RWD, 4WD Quad Suspension Rearward of Front Axle, Non Quad Suspension		
F 75-91	VAN 3/4 TON, ECONOLINE / CLUB WAGON / SUPERDUTY All		
81484	B		141137
R 75-79	FORD PICKUP 1 TON, F-350 / SUPERDUTY Standard Cab Pickup, RWD		
R 73-74	PICKUP 1 TON, F-350 / SUPERDUTY All RWD; Exc. Supercab		
R 69-74	VAN 1 TON, ECONOLINE / CLUB WAGON / SUPERDUTY All		
R 69-74	VAN 3/4 TON, ECONOLINE / CLUB WAGON / SUPERDUTY All		
81490	C		140780
F 86-90	FORD F-200 All		
F 97	F-250 HD RWD		
F 80-97	PICKUP 1 TON, F-350 / SUPERDUTY RWD		
81496	D		
F 81-86	CHEVROLET PICKUP 3/4 TON, K20 All Quad Suspension Long Shock; Exc. Lift Kit		
F 87	PICKUP 3/4 TON, V20 All Quad Suspension Long Shock; Exc. Lift Kit		
R 78-95	VAN 1/2 TON, G / EXPRESS All		
R 78-95	VAN 1 TON, G / EXPRESS Cutaway Van		
R 78-95	VAN 3/4 TON, G / EXPRESS All Exc. 8600# GVW		
R 99-03	DODGE VAN 1/2 TON, A / B SERIES / RAM 109.3 / 277.6 (WheelBase) Exc. 7000# GVW		

Guardian Shock

Shock	POP	Alternative No.	MTG Acc. Supplied
Pos.	Year	Application	
81496	D (cont)		
R 81-98	VAN 1/2 TON, A / B SERIES / RAM 109.6 / 278.4 (WheelBase) Exc. 7000# GVW		
R 71-80	VAN 1/2 TON, A / B SERIES / RAM All		
R 71-03	VAN 1 TON, A / B SERIES / RAM All		
R 71-03	VAN 3/4 TON, A / B SERIES / RAM All		
R 74-80	VAN, CB300 All		
F 87-88	GMC PICKUP 1 TON, V3000 / V3500 All Quad Suspension Long Shock; Exc. Lift Kit		
F 81-86	PICKUP 3/4 TON, K25 / K2500 All Quad Suspension Long Shock; Exc. Lift Kit		
F 87	PICKUP 3/4 TON, V2500 All Quad Suspension Long Shock; Exc. Lift Kit		
R 78-95	VAN 1/2 TON, G / SAVANA All		
R 85-96	VAN 1 TON, G / SAVANA Extended Cargo Van		
R 85-96	VAN 1 TON, G / SAVANA Extended Passenger Van		
R 79-96	VAN 1 TON, G / SAVANA Standard Cargo Van		
R 79-96	VAN 1 TON, G / SAVANA Standard Passenger Van		
R 78	VAN 1 TON, G / SAVANA Cutaway Van		
R 78-95	VAN 3/4 TON, G / SAVANA All Exc. 8600# GVW		
R 81-83	PLYMOUTH VAN 1/2 TON, PB SERIES All		
R 74-83	VAN 1 TON, PB SERIES All		
R 74-83	VAN 3/4 TON, PB SERIES All		
81510	C		
R 97	FORD F-250 HD 4WD		
R 86-97	PICKUP 1 TON, F-350 / SUPERDUTY 4WD Dual Rear Wheels		
R 82-85	PICKUP 1 TON, F-350 / SUPERDUTY 4WD Clevis Type Lower Front Mount; Exc. Dual Rear Wheels or Lift Kit		
R 80-81	PICKUP 1 TON, F-350 / SUPERDUTY 4WD		
81667	C		
R 88-00	CHEVROLET PICKUP 1 TON, C35/3500 Extended Cab Pickup Exc. HD Straight Front Axle		
R 88-00	PICKUP 1 TON, C35/3500 Standard Cab Pickup Exc. HD Straight Front Axle		
R 88-00	PICKUP 1 TON, K35 / K3500 All		
R 88-00	PICKUP 3/4 TON, C25 / C2500 All		
R 88-00	PICKUP 3/4 TON, K25 / K2500 All		
R 89-00	GMC PICKUP 1 TON, C35/3500 Extended Cab Pickup Exc. HD Straight Front Axle		
R 88-00	PICKUP 1 TON, C35/3500 Standard Cab Pickup Exc. HD Straight Front Axle		
R 88-00	PICKUP 1 TON, K35 / K3500 All		
R 88-00	PICKUP 3/4 TON, C25 / C2500 All		
R 88-00	PICKUP 3/4 TON, K25 / K2500 All		
81668	C		141277
F 92-00	CHEVROLET PICKUP 1 TON, C35/3500 All Exc. HD Straight Front Axle		
F 88-91	PICKUP 1 TON, C35/3500 Extended Cab Pickup Exc. HD Straight Front Axle		
F 88-91	PICKUP 1 TON, C35/3500 Standard Cab Pickup Exc. HD Straight Front Axle		
F 88-00	PICKUP 3/4 TON, C25 / C2500 All		
F 88-00	GMC PICKUP 1 TON, C35/3500 All Exc. HD Straight Front Axle		
F 88-00	PICKUP 3/4 TON, C25 / C2500 All		
81676	A		
R 53-55	FORD PICKUP 1 TON, F-350 / SUPERDUTY All		
81710	C		
R 80-97	FORD PICKUP 1 TON, F-350 / SUPERDUTY RWD Dual Rear Wheels		
81713	C		140800
F 96-02	CHEVROLET VAN 1 TON, G / EXPRESS All		

Numerical listing

Shock	POP	Alternative No.	MTG Acc. Supplied
Pos.	Year	Application	
81713	C (cont)		140800
F 96-02	VAN 3/4 TON, G / EXPRESS All Exc. 8600# GVW		
F 96-02	GMC VAN 1/2 TON, G / SAVANA RWD		
F 96-02	VAN 1 TON, G / SAVANA All		
F 96-02	VAN 3/4 TON, G / SAVANA All Exc. 8600# GVW		
81726	W		
F 88-00	CHEVROLET PICKUP 1 TON, K35 / K3500 All		
F 88-00	PICKUP 3/4 TON, K25 / K2500 All		
F 88-00	GMC PICKUP 1 TON, K35 / K3500 All		
F 88-00	PICKUP 3/4 TON, K25 / K2500 All		
81744	A		140780
F 21-24	FORD VAN 1 TON, ECONOLINE / CLUB WAGON / SUPERDUTY All		
F 92-19	VAN 1 TON, ECONOLINE / CLUB WAGON / SUPERDUTY All		
F 92-14	VAN 3/4 TON, ECONOLINE / CLUB WAGON / SUPERDUTY All		
81821	D		
F 97	FORD F-250 HD 4WD		
F 86-97	PICKUP 1 TON, F-350 / SUPERDUTY 4WD		
81825	D		
F 81-93	DODGE PICKUP 1 TON, W300 SERIES All Exc. Quad Suspension and Lift Kit		
F 61-80	PICKUP 1 TON, W300 SERIES All		
R 61-71	PICKUP 1 TON, W300 SERIES All		
F 90-93	PICKUP 3/4 TON, W200 SERIES Extended Cab Pickup Exc. Lift Kit		
F 88-93	PICKUP 3/4 TON, W200 SERIES Cab & Chassis Exc. Lift Kit		
F 81-93	PICKUP 3/4 TON, W200 SERIES Standard Cab Pickup Exc. Lift Kit		
F 86	PICKUP 3/4 TON, W200 SERIES Cab & Chassis Exc. Lift Kit		
F 81-83	PICKUP 3/4 TON, W200 SERIES Cab & Chassis Exc. Lift Kit		
F 81-82	PICKUP 3/4 TON, W200 SERIES Extended Cab Pickup Exc. Lift Kit		
F 69-80	PICKUP 3/4 TON, W200 SERIES All		
F 61-67	PICKUP 3/4 TON, W200 SERIES All		
81828	W		142617
R 21-24	FORD VAN 1 TON, ECONOLINE / CLUB WAGON / SUPERDUTY All		
R 10-19	VAN 1 TON, ECONOLINE / CLUB WAGON / SUPERDUTY All		
R 04-19	VAN 1 TON, ECONOLINE / CLUB WAGON / SUPERDUTY All Exc. Cutaway Chassis		
R 92-05	VAN 1 TON, ECONOLINE / CLUB WAGON / SUPERDUTY All		
R 92-14	VAN 3/4 TON, ECONOLINE / CLUB WAGON / SUPERDUTY All		
81834	W		140126
F 72-93	DODGE PICKUP 1 TON, D300 SERIES All Heavy Duty Package		
F 82-93	PICKUP 3/4 TON, D200 SERIES All Heavy Duty Package		
F 75-81	PICKUP 3/4 TON, D200 SERIES 165.0 / 419.1 (WheelBase) Heavy Duty Package		
F 72-74	PICKUP 3/4 TON, D200 SERIES All Heavy Duty Package		
F 71-93	VAN 1 TON, A / B SERIES / RAM All 4000# Front Axle		
F 74-80	VAN, CB300 All 4000# Front Axle		
F 74-83	PLYMOUTH VAN 1 TON, PB SERIES All 4000# Front Axle		
81914	D		142731
F 75-91	FORD VAN 1/2 TON, ECONOLINE / CLUB WAGON All		
81919	D		142731
F 99-02	DODGE PICKUP 3/4 TON, RAM 2500 (SEE RAM 2500) 4WD Exc. 8800# GVW		
F 94-95	PICKUP 3/4 TON, RAM 2500 (SEE RAM 2500) 4WD Exc. 8800# GVW		
81920	B		141665
F 99-04	CHEVROLET PICKUP 3/4 TON, SILVERADO 2500 RWD Exc. Electronic Adjustable Suspension		

Numerical listing

Guardian Shock, Classic Shock Absorbers, Cab Shock, 83000 Series

Numerical listing

Shock	POP	Alternative No.	MTG Acc. Supplied
Pos.	Year	Application	
81920	B (cont)		141665
F 01-04	PICKUP 3/4 TON, SILVERADO 2500 HD RWD		
F 99-04	GMC SIERRA 2500 RWD Exc. Electronic Adjustable Suspension		
F 01-04	SIERRA 2500 HD RWD		
81921	A		
R 77-86	CHEVROLET PICKUP 1 TON, K30 All		
R 90-91	PICKUP 1 TON, R3500 All		
R 89	PICKUP 1 TON, R3500 Cab & Chassis, RWD		
R 89	PICKUP 1 TON, R3500 Crew Cab Pickup, RWD		
R 01-09	PICKUP 1 TON, SILVERADO 3500 All		
R 08-10	PICKUP 1 TON, SILVERADO 3500 HD All		
R 87-88	PICKUP 1 TON, V30 All		
R 89-91	PICKUP 1 TON, V3000 / V3500 All		
R 99-08	PICKUP 3/4 TON, SILVERADO 2500 All		
R 01-10	PICKUP 3/4 TON, SILVERADO 2500 HD All		
R 07	SILVERADO 3500 CLASSIC All		
R 94-02	DODGE PICKUP 1 TON, RAM 3500 (SEE RAM 3500) 4WD		
R 94-02	PICKUP 1 TON, RAM 3500 (SEE RAM 3500) RWD Solid Front Axle		
R 94-02	PICKUP 3/4 TON, RAM 2500 (SEE RAM 2500) 4WD 8800# GVW		
R 77-86	GMC PICKUP 1 TON, K35 / K3500 All		
R 87-91	PICKUP 1 TON, V3000 / V3500 All		
R 99-04	SIERRA 2500 All		
R 01-10	SIERRA 2500 HD All		
R 01-06	SIERRA 3500 All		
R 07-10	SIERRA 3500 HD All		
81925	D		141665
F 01-09	CHEVROLET PICKUP 1 TON, SILVERADO 3500 All		
F 05-08	PICKUP 3/4 TON, SILVERADO 2500 All		
F 99-04	PICKUP 3/4 TON, SILVERADO 2500 4WD		
F 99-04	GMC SIERRA 2500 4WD		
81928	W		143000
F 94-02	DODGE PICKUP 1 TON, RAM 3500 (SEE RAM 3500) RWD Exc. Solid Front Axle		
F 94-02	PICKUP 3/4 TON, RAM 2500 (SEE RAM 2500) RWD		
Classic Shock Absorbers			
82003	A		
R 67-72	CHEVROLET PICKUP 3/4 TON, C20 All Coil(RearSpringType)		
R 64-66	VAN 1/2 TON, G / EXPRESS All		
R 67-72	VAN 1/2 TON, P SERIES All		
R 67-72	GMC PICKUP 3/4 TON, C25 / C2500 All Coil(RearSpringType)		
R 64-66	VAN 1/2 TON, G / SAVANA All		
R 68-72	VAN 1/2 TON, P SERIES All		
82007	B		140349
R 61-67	FORD ECONOLINE All		
F 68-72	INTERNATIONAL M1100 / M1200 All		
F 69	M1400 All		
82012	C		
F 69-74	FORD VAN 1 TON, ECONOLINE / CLUB WAGON / SUPERDUTY All		
F 69-74	VAN 3/4 TON, ECONOLINE / CLUB WAGON / SUPERDUTY All		
82026	A		140455
F 49-52	CHEVROLET FLEETLINE All		
F 49-52	FLEETLINE TRUCK All		
82035	C		140357
F 61-62	CHEVROLET PICKUP 1 TON, C30 All		
F 60-62	PICKUP 3/4 TON, C20 All		
F 61-62	VAN 1/2 TON, P SERIES All		
F 61-62	GMC PICKUP 2500 SERIES All		
82047	A		140630
F 61-67	CHEVROLET VAN 1 TON, P SERIES All		
F 61-67	VAN 3/4 TON, P SERIES All		
F 67	GMC VAN 1 TON, P SERIES All		
F 67	VAN 3/4 TON, P SERIES All		

Shock	POP	Alternative No.	MTG Acc. Supplied
Pos.	Year	Application	
82065	C		140478
R 74	DODGE M300 All		
R 74	M350 All		
R 61-71	PICKUP 1 TON, D300 SERIES All		
F 60	PICKUP 3/4 TON, D200 SERIES All		
F 60	PICKUP 3/4 TON, W200 SERIES All		
R 66-72	VAN 1 TON, P SERIES All		
R 61-64	VAN 1 TON, P SERIES All		
82066	A		140455
R 49-52	CHEVROLET FLEETLINE All		
R 49-52	FLEETLINE TRUCK All		
82086	B		
R 60-62	CHEVROLET PICKUP 3/4 TON, C20 All		
R 61-62	VAN 1/2 TON, P SERIES All		
82155	A		141041
R 61-62	CHEVROLET VAN 1 TON, P SERIES All		
R 61-62	VAN 3/4 TON, P SERIES All		
Cab Shock			
83006	W		
95-05	FREIGHTLINER FL50 All Day Cab Suspensions with O.E.M. Number		
83021	C		
90-96	CHEVROLET C60 KODIAK All Truck Cabs with Link Cabmate Model GMC104TK		
03-09	C4500 KODIAK All Truck Cabs with Link Cabmate Model GMC104TK		
03-09	C5500 KODIAK All Truck Cabs with Link Cabmate Model GMC104TK		
90-91	C5500 KODIAK All Truck Cabs with Link Cabmate Model GMC104TK		
00-01	C7500 KODIAK All Truck Cabs with Link Cabmate Model GMC104TK		
03-09	GMC C4500 TOPKICK All Truck Cabs with Link Cabmate Model GMC104TK		
03-09	C5500 TOPKICK All Truck Cabs with Link Cabmate Model GMC104TK		
05-08	ISUZU HVR All Truck Cabs with Link Cabmate Model GMC104TK		
96-97	MARMON HERRINGTON 57 GLIDER All Conventional Tractors with Link Cabmate Model MARC57-B		
90-94	57 GLIDER All Conventional Tractors with Link Cabmate Model MARC57-B		
83025	C		
03-09	GMC C4500 TOPKICK All Models with Link Cabmate Model GMT560		
03-09	C5500 TOPKICK All Models with Link Cabmate Model GMT560		
83054	W		
15-20	INTERNATIONAL DURASTAR All Models with O.E.M. Number		
13	DURASTAR All Models with O.E.M. Number		
83066	W		
23	MACK MD6		
24	MD6 All Models with O.E.M. Number		
21-22	MD6 All Models with O.E.M. Number		
83000 Series			
83103	W		145054 (2)
R 93-99	MITSUBISHI CANTER FE516BC		
R 88-95	CANTER FH100		
R 88-96	MITSUBISHI FUSO FH All Models with O.E.M. Number		
83114	W		140780 (1)
F 00-04	ISUZU FRR All		
F 95-98	FRR All		
F 86	FSR		
F 88-94	NRR All		
F 00-01	MITSUBISHI CANTER 35		
F 00-05	CANTER 55		
F 01-05	CANTER 60		
F 01-05	CANTER 75		
F 01-10	CANTER FB SERIES		
F 86-95	CANTER FE SERIES		
F 90-95	CANTER FH100		
F 87-08	CANTER FK SERIES		

Shock	POP	Alternative No.	MTG Acc. Supplied
Pos.	Year	Application	
83114	W (cont)		140780 (1)
F 76-84	CANTER FK SERIES		
F 76-84	CANTER FM SERIES		
F 03-08	CANTER FN SERIES		
F 01-10	MITSUBISHI FUSO FE SERIES		
F 89-94	UD 1800 All Models with O.E.M. Number		
F 99-04	1800CS All Models with O.E.M. Number		
F 89-94	2000 All Models with O.E.M. Number		
83120	W		145089-000(1)/145143(1)
R 95-05	FREIGHTLINER FL50 All Models with 15,000 lb Rear Suspension		
R 98-20	MT45 All Models with O.E.M. Number		
R 99-11	MT55 All Models with O.E.M. Number		
R	UPS TRUCK VARIOUS		
83122	W		
R 00-01	CHEVROLET C7500 KODIAK All Models with Hendrickson Air Suspension (Stamping number 47902-13)		
R 99	T6500 All Models with Hendrickson Air Suspension (Stamping number 47902-13)		
R 99	T7500 All Models with Hendrickson Air Suspension (Stamping number 47902-13)		
R 04-09	T8500 All Models with Hendrickson Air Suspension (Stamping number 47902-13)		
R 99	GMC T5500		
R 99	T6500 All Models with Hendrickson Air Suspension (Stamping number 47902-13)		
R	ISUZU FVR		
R 05-08	HVR All Models with Hendrickson Air Suspension		
83123	C		
R 13-24	KENWORTH K270 All Models with Hendrickson HAS - 210L or HAS - 230L Rear Air Suspension		
R 08-23	T270 All Models with Hendrickson HAS - 210L or HAS - 230L Rear Air Suspension		
83126	D		
F 05-10	HINO 145 All Models with O.E.M. Number		
F 05-10	165 All Models with O.E.M. Number		
F 05-10	185 All Models with O.E.M. Number		
R 13-24	KENWORTH K270 All Models with Reyco 102 or 79KB Suspension (Drive Axle)		
R 08-22	T170 All Models with Reyco 79KB Rear Steel Spring Suspension		
R 08-23	T270 All Models with Reyco 102 or 79KB Suspension (Drive Axle)		
R 21-24	T280 All Models with Reyco 102 or 79KB Suspension (Drive Axle)		
R 08-15	PETERBILT 210 All Models with Reyco 102 or 79KB Suspension (Drive Axle)		
R 08-19	325 All Models with Reyco 102 or 79KB Suspension (Drive Axle)		
83127	C		
F 23	MACK MD6		
F 24	MD6 All Models with 10,000 lb Taperleaf Springs		
F 21-22	MD6 All Models with 10,000 lb Taperleaf Springs		
83134	W		145054 (1)
R 02-10	FREIGHTLINER M2 100 All Models with Rear 52" Spring, 10,000 lb - 15,000 lb		
R 02-10	M2 100 All Models with Rear 52" Spring, 18,000 lb - 23,000 lb		
83135	C		
F 22-25	CHEVROLET 4500HD		
F 22-25	5500HD		
F 22-25	6500HD		
F 19-22	SILVERADO 4500 HD All Models with 7,000 to 8,000 lb Front Axle		
F 19-22	SILVERADO 5500 HD All Models with 7,000 to 8,000 lb Front Axle		
F 19-22	SILVERADO 6500 HD All Models with 7,000 to 8,000 lb Front Axle		

Numerical listing

Shock	POP	Alternative No.	MTG Acc. Supplied
Pos.	Year	Application	
83135	C (cont)		
F	10-12	INTERNATIONAL DURASTAR - 4300, 4400 SERIES	
F	12-18	TERRASTAR All Models with 6,000 to 7,000 lb Front Axle	
83136	W		145054 (2)
F	90-96	CHEVROLET C60 KODIAK All Conventional Cab w/ Front Shock with O.E.M. Number	
R	90-96	C60 KODIAK All Conventional Cab w/19000, 21000, 23000 lb Taperleaf Springs (EXC Low Profile Vehicle)	
F	90-02	C4500 KODIAK	
R	90-02	C4500 KODIAK	
F	03-09	C4500 KODIAK All C Chassis - Conventional Cab	
R	03-09	C4500 KODIAK All C Chassis - Conventional Cab w/19000, 21000, 23000 lb Taperleaf Springs (EXC Low Profile Vehicle)	
F	92-02	C5500 KODIAK	
R	92-02	C5500 KODIAK	
F	03-09	C5500 KODIAK All C Chassis - Conventional Cab	
R	03-09	C5500 KODIAK All C Chassis - Conventional Cab w/19000, 21000, 23000 lb Taperleaf Springs (EXC Low Profile Vehicle)	
F	90-91	C5500 KODIAK All C Chassis - Conventional Cab	
R	90-91	C5500 KODIAK All C Chassis - Conventional Cab w/19000, 21000, 23000 lb Taperleaf Springs (EXC Low Profile Vehicle)	
F	00-01	C7500 KODIAK All Conventional Cab w/ Front Shock with O.E.M. Number	
R	00-01	C7500 KODIAK All Conventional Cab w/19000, 21000, 23000 lb Taperleaf Springs (EXC Low Profile Vehicle)	
R	92-96	P60 All Motorhome Chassis	
R	92-96	P6000 All Motorhome Chassis	
F	97-09	T5500	
R	92-99	T5500	
F	03	T6500	
R	92-96	T6500	
F	04-09	T6500 All FL1 Tilt Cab with 8100 lb Axle	
F	04-09	T6500 All FL2 Tilt Cab with 5000 to 11000 lb Axle	
F	04-09	T6500 All FL3 Tilt Cab with 14575 lb Axle	
R	00-02	T6500 All Tilt Cab with 23,000 lb Axles; Tapered Leaf Spring	
F	97-02	T6500 All FL1 Tilt Cab with 8100 lb Axle	
F	97-02	T6500 All FL2 Tilt Cab with 5000 to 11000 lb Axle	
F	97-02	T6500 All FL3 Tilt Cab with 14575 lb Axle	
R	97-99	T6500 All Tilt Cab w/19000, 21000, 23000 lb Taperleaf Springs (EXC Low Profile Veh.)	
F	04-09	T7500 All FL1 Tilt Cab with 8100 lb Axle	
F	04-09	T7500 All FL2 Tilt Cab with 5000 to 11000 lb Axle	
F	04-09	T7500 All FL3 Tilt Cab with 14575 lb Axle	
R	00-02	T7500 All Tilt Cab with 23,000 lb Axles; Tapered Leaf Spring	
F	97-02	T7500 All FL1 Tilt Cab with 8100 lb Axle	
F	97-02	T7500 All FL2 Tilt Cab with 5000 to 11000 lb Axle	
F	97-02	T7500 All FL3 Tilt Cab with 14575 lb Axle	
R	97-99	T7500 All Tilt Cab w/19000, 21000, 23000 lb Taperleaf Springs (EXC Low Profile Veh.)	
F	04-09	T8500 All FL1 Tilt Cab with 8100 lb Axle	
F	04-09	T8500 All FL2 Tilt Cab with 5000 to 11000 lb Axle	
F	04-09	T8500 All FL3 Tilt Cab with 14575 lb Axle	
R	92-96	VAN 1 TON, P SERIES All Motorhome Chassis	
F	90-02	GMC C4500 TOPKICK	
R	90-02	C4500 TOPKICK	

83000 Series

Shock	POP	Alternative No.	MTG Acc. Supplied
Pos.	Year	Application	
83136	W (cont)		145054 (2)
R	03-09	C4500 TOPKICK All C Chassis - Conventional Cab with 19000, 21000, 23000 lb Taperleaf Springs (EXC Low Profile Vehicle)	
F	03-09	C4500 TOPKICK All C Chassis - Conventional Cab with Front Shock with O.E.M. Number	
F	90-02	C5500 TOPKICK	
R	90-02	C5500 TOPKICK	
R	03-09	C5500 TOPKICK All C Chassis - Conventional Cab with 19000, 21000, 23000 lb Taperleaf Springs (EXC Low Profile Vehicle)	
F	03-09	C5500 TOPKICK All C Chassis - Conventional Cab with Front Shock with O.E.M. Number	
F	97-09	T5500	
R	92-99	T5500	
F	03	T6500	
R	92-96	T6500	
F	04-09	T6500 All FL1 Tilt Cab with 8100 lb Axle	
F	04-09	T6500 All FL2 Tilt Cab with 5000 to 11000 lb Axle	
F	04-09	T6500 All FL3 Tilt Cab with 14575 lb Axle	
R	00-02	T6500 All Tilt Cab with 23,000 lb Axles; Tapered Leaf Spring	
F	97-02	T6500 All FL1 Tilt Cab with 8100 lb Axle	
F	97-02	T6500 All FL2 Tilt Cab with 5000 to 11000 lb Axle	
F	97-02	T6500 All FL3 Tilt Cab with 14575 lb Axle	
R	97-99	T6500 All Tilt Cab with 19000, 21000, 23000 lb Taperleaf Springs (EXC Low Profile Veh.)	
R	97-09	ISUZU FTR All Models with 19000, 21000, 23000 lb Taperleaf Springs (EXC Low Profile Veh.)	
F	90-09	FTR All Models with O.E.M. Number	
F	05-08	HVR All Conventional Cab with OEM Number;	
83137	W		
R	00-01	CHEVROLET C7500 KODIAK All Models with Hendrickson Air Suspension with O.E.M. Number	
R	18-24	ISUZU FTR All Models with Hendrickson HAS suspension	
R	00-11	FTR All Models with Hendrickson HAS suspension	
R	13-24	KENWORTH K270 All Models with Hendrickson HAS - 230 Rear Air Suspension	
R	08-14	T270 All Models with Hendrickson HAS - 400 (Standard) Rear Air Suspension	
83140	D		415010-802(2)/145148(2)
F	05-10	HINO 185 All Models with O.E.M. Number	
F	05-14	238 All Models with O.E.M. Number	
F	06-14	258 All Models with O.E.M. Number	
F	05-14	268 All Models with O.E.M. Number	
F	08-14	268A All Models with O.E.M. Number	
83141	W		415010-802(2)/145148(2)
F	98-04	HINO FB1817 All FE Models Trucks with:	
F	98-04	FE SERIES	
83142	C		145128 (1)
R	02-10	FREIGHTLINER M2 100 All Models with Hendrickson HMX 400/460 Haulmax with 17.5" & 18.5" Saddle	
83143	D		145128 (1)
R	02-10	FREIGHTLINER M2 100 All Models with Hendrickson HMX 400/460 Haulmax with 16.5" Saddle	
R	08-23	KENWORTH T270 All Models with Hendrickson HMX 400/460 Haulmax with 16.5" Saddle	
83148	D		
R		HINO ADDITIONAL APPLICATIONS	
83154	D		145089-000 (1)
R	98-23	FREIGHTLINER MT45 All Walkin Step Van Models (18 Foot) with O.E.M. Number	
R		MT55	

Numerical listing

Shock	POP	Alternative No.	MTG Acc. Supplied
Pos.	Year	Application	
83157	W		
F	99-20	FREIGHTLINER MT45 All MT45 Step Van - w/35" Front Spring	
F	99-20	MT55 All MT55 Step Van - w/35" Front Spring	
83159	W		TR0027 (4)
R	24-25	CHEVROLET LCF 3500	
R	16-23	LCF 3500 All	
R	18	LCF 3500HD	
R	16-17	LCF 3500HD All	
R	17-25	LCF 4500 All	
R	17-25	LCF 4500HD All	
R	25	LCF 5500XD	
R	17-24	LCF 5500XD All	
R	17-24	LCF 5500XD All With OEM Number 983439850	
R	19-22	SILVERADO 4500 HD All Diesel Low Cab Forward models with 14,000 to 15,000 lb Rear	
R	19-22	SILVERADO 4500 HD All Diesel Low Cab Forward models with 15,000 to 16,000 lb Rear	
R	19-22	SILVERADO 5500 HD All Diesel Low Cab Forward models with 14,000 to 15,000 lb Rear	
R	19-22	SILVERADO 5500 HD All Diesel Low Cab Forward models with 15,000 to 16,000 lb Rear	
R	00-10	GMC W4500 FORWARD All Models with 11000 lb and 13000 lb Suspension	
R	00-09	W5500 FORWARD All Models with 11000 lb and 13000 lb Suspension	
R	05-09	ISUZU FTR All Models with O.E.M. Number	
R	95-20	NPR All Models with O.E.M. Number	
R	20-23	NPR-HD All Models with 14,000 to 15,000 lb Rear	
R	20-23	NPR-HD All Models with 15,000 to 16,000 lb Rear	
R	03-23	NPR-HD All Models with O.E.M. Number	
R	23	NPR-XD	
R	15-22	NPR-XD All Models with 14,000 to 15,000 lb GVW	
R	15-22	NPR-XD All Models with 15,000 to 16,000 lb Rear	
R	20-23	NQR All Models with 15,000 to 16,000 lb Rear	
R	03-19	NQR All Models with O.E.M. Number	
R	02	NQR All Diesel	
R	95-97	NQR All Diesel	
R	20-23	NRR All Models with 15,000 to 16,000 lb Rear	
R	05-19	NRR All Models with O.E.M. Number	
R	11-15	REACH All Models with O.E.M. Number	
83162	W		140780(1)/145116 & 406422 & 415010-802(1)
F	86	ISUZU FSR	
F	89-13	UD 2600 All Models with O.E.M. Number	
83163	B		
F	00-02	CHEVROLET T6500 All Low profile, with Axle Code FL1	
F	00-02	T7500 All Low profile, with Axle Code FL1	
F	00-02	GMC T6500 All Low profile, with Axle Code FL1	
F	15-19	INTERNATIONAL DURASTAR All Models with 9,000 to 10,000 lb Front Suspension	
F	13	DURASTAR All Models with 9,000 to 10,000 lb Front Suspension	
F	19-22	MV607 All Models with 9,000 to 10,000 lb Front Suspension	
83164	W		
F	99-20	FREIGHTLINER MT45 All MT45 Step Van - w/38" Front Spring	
F	99-20	MT55 All MT55 Step Van - w/38" Front Spring	
83166	W		
R	08-14	HINO 238 All Models with Hendrickson Comfort Air (Single Axle - 19K)	
R	08-20	258 All Models with Hendrickson Comfort Air (Single Axle - 19K)	

Numerical listing

Shock	POP	Alternative No.	MTG Acc. Supplied
Pos.	Year	Application	
83166	W	(cont)	
R	08-14	258ALP	All Models with Hendrickson Comfort Air (Single Axle - 19K)
R	08-20	268	All Models with Hendrickson Comfort Air (Single Axle - 19K)
R	08-14	268A	All Models with Hendrickson Comfort Air (Single Axle - 19K)
R	22-24	L6	All Models with Hendrickson Comfort Air (Single Axle - 19K, 21K & 23K)
R	21-24	L6	All Models with Hendrickson Comfort Air (Single Axle - 19K, 21K & 23K)
R	21	L6	All Models with Hendrickson Comfort Air (Single Axle - 19K)
R	21-22	LION LION6	All Models with Hendrickson Comfort Air Suspension (21K Capacity)
83168	W	HINO 268, 268A SERIES	
83169	W	(cont)	
F	15-20	INTERNATIONAL DURASTAR	All Models with 6,000 to 8,000 lb Front Suspension
F	13	DURASTAR	All Models with 6,000 to 8,000 lb Front Suspension
F	13-18	DURASTAR - 4300, 4400 SERIES	
F	19-22	MV607	All Models with 6,000 to 8,000 lb Front Suspension
83180	W	(cont)	
R	14	INTERNATIONAL TERRASTAR	All 4 WD Models with Rear Spring Suspension
83215	W	401754 (4)	
R	86-87	HINO FD16	All Models with O.E.M. Number
R	88-92	FD17	All Models with O.E.M. Number
R	93-97	FD2218	All (FD5H), FE5H, FF5H
R	93-97	FD2218LD	
R	93-97	FD2218LP	All Models with O.E.M. Number
R	98	FE2620	All
83216	W	140149 (1)	
R	89-91	HINO FA14	All FA, FB Models Trucks with:
R	92	FA15	All FA, FB Models Trucks with:
R	93-97	FA1415	All (FA15)
R	93-97	FA1415	All FA, FB Models Trucks with:
R	93-97	FA1415	All FA1415 (FA15), FB1715 (FB15)
R	98-04	FA1517	All FA, FB Models Trucks with:
R	98	FA1517	All
R	98	FA1517	All FA1517, FA1817, FB1817
R	98	FA1817	
R	89-91	FB14	All FA, FB Models Trucks with:
R	92	FB15	All FA, FB Models Trucks with:
R	93-97	FB1715	All FA, FB Models Trucks with:
R	93-97	FB1715	All FA1415 (FA15), FB1715 (FB15)
R	98-04	FB1817	All FA, FB Models Trucks with:
R	98	FB1817	All
R	98	FB1817	All FA1517, FA1817, FB1817
F	93-97	FD2218	All (FD5H), FE5H, FF5H
F	93-97	FD2218LP	All Models with O.E.M. Number
F	86-87	FE16	All
F	90-91	GC17	All GC17
F	92	GC20	All GC20
83221	W	(cont)	
R	83-99	CHEVROLET C4500 KODIAK	
R	92-99	C5500 KODIAK	
R	83-89	C5500 KODIAK	
R	90-91	C5500 KODIAK	All C Chassis - Conventional Cab with 9100 to 17500 lb Rear Axle
83243	W	(cont)	
R	25	CHEVROLET SILVERADO 4500HD	
R	22-24	SILVERADO 4500 HD	All Models with 4X4 Rear

83000 Series, 85000 Series

Shock	POP	Alternative No.	MTG Acc. Supplied
Pos.	Year	Application	
83243	W	(cont)	
R	19-21	SILVERADO 4500 HD	All Models with 4 x 4 Rear
R	25	SILVERADO 5500HD	
R	23-24	SILVERADO 5500 HD	All Models with 4X4 Rear
R	19-22	SILVERADO 5500 HD	All Models with 4 x 4 Rear
R	25	SILVERADO 6500HD	
R	23-24	SILVERADO 6500 HD	All Models with 4X4 Rear
R	19-22	SILVERADO 6500 HD	All Models with 4 x 4 Rear
83308	W	140149 (1)	
F	80-86	FORD C600	All Models with 3100 lb Spring and 7000 lb Axle
83312	W	140149 (1)	
F	80-86	FORD C600	All Models with 4040, 5040 lb Springs and 7000, 9000, 12000 lb Axles
83317	W	141083 (1)	
R	13	INTERNATIONAL DURASTAR	All Models with 22,000 lb Rear Spring Suspension
83364	W	(cont)	
R	06-09	FORD LCF450	
R	06-09	LCF550	
R	06-09	INTERNATIONAL CF500	All w/ vari-rate suspension
R	16-20	DURASTAR	All Models with 10,500 or 13,500 lb Vari-Rate Rear Spring Suspension
R	12-18	TERRASTAR	All Models with 10,500 or 13,500 lb Vari-Rate Rear Spring Suspension
83391	W	145177 (2)	
F	15-20	HINO 258	All Models with O.E.M. Number
F	15-20	268	All Models with O.E.M. Number
F	22-24	L6	
F	21	L6	All Models with O.E.M. Number
83395	W	145054 (1)	
R	16-17	INTERNATIONAL DURASTAR	All Models with Vari-Rate Rear Spring Suspension
83397	W	(cont)	
F	25	CHEVROLET SILVERADO 4500HD	
F	19-24	SILVERADO 4500 HD	All Models with Taperleaf Front
F	25	SILVERADO 5500HD	
F	19-24	SILVERADO 5500 HD	All Models with Taperleaf Front
F	25	SILVERADO 6500HD	
F	19-24	SILVERADO 6500 HD	All Models with Taperleaf Front
F	24	INTERNATIONAL CV515	
83398	W	(cont)	
R	25	CHEVROLET SILVERADO 4500HD	
R	19-24	SILVERADO 4500 HD	All Models with 11K, 13.5K or 15.5K VARI-RATE Rear Suspension
R	25	SILVERADO 5500HD	
R	19-24	SILVERADO 5500 HD	All Models with 11K, 13.5K or 15.5K VARI-RATE Rear Suspension
R	25	SILVERADO 6500HD	
R	19-24	SILVERADO 6500 HD	All Models with 11K, 13.5K or 15.5K VARI-RATE Rear Suspension
R	24	INTERNATIONAL CV515	
83515	W	141041	
F	24-25	CHEVROLET LCF 3500	
F	16-23	LCF 3500	All
F	18	LCF 3500HD	
F	16-17	LCF 3500HD	All
F	17-25	LCF 4500	All With OEM Number
F	17-25	LCF 4500HD	All With OEM Number
F	17-25	LCF 4500XD	All With OEM Number
F	25	LCF 5500XD	
F	17-24	LCF 5500XD	All With OEM Number
F	19-22	SILVERADO 4500 HD	All Diesel Low Cab Forward models with 14,500 lb GVWR
F	19-22	SILVERADO 4500 HD	All Diesel Low Cab Forward models with 16,000 lb to 19,500 lb GVWR

Numerical listing

Shock	POP	Alternative No.	MTG Acc. Supplied
Pos.	Year	Application	
83515	W	(cont)	
F	19-22	SILVERADO 5500 HD	All Diesel Low Cab Forward models with 14,500 lb GVWR
F	19-22	SILVERADO 5500 HD	All Diesel Low Cab Forward models with 16,000 lb to 19,500 lb GVWR
F	87-10	W4500 TILTMMASTER	All Models with 11000 lb & 13000 lb Suspension
F	88-10	W5500 TILTMMASTER	All Models with 11000 lb & 13000 lb Suspension
F	87-96	W6500 TILTMMASTER	All Models with 11000 lb & 13000 lb Suspension
F	00-08	GMC W3500 FORWARD	All Models with 11000 lb and 13000 lb suspension
F	92-10	W4500 FORWARD	All Models with 11000 lb & 13000 lb Suspension
F	88-10	W5500 FORWARD	All Models with 11000 lb & 13000 lb Suspension
F	87-96	W6500 FORWARD	All Models with 11000 lb & 13000 lb Suspension
F	85	ISUZU ADDITIONAL APPLICATIONS	ALL MODELS WITH
F	86	FSR	
F	05-09	FTR	All Models with O.E.M. Number
F	84-85	NPR	
F	86-20	NPR	All Models with O.E.M. Number
F	99-23	NPR-HD	All Models with O.E.M. Number
F	23	NPR-XD	
F	15-22	NPR-XD	All Models with 14,000 to 15,000 lb GVW
F	15-22	NPR-XD	All Models with 15,000 to 16,000 lb GVW
F	94-23	NQR	All Models with O.E.M. Number
F	05-23	NRR	All Models with O.E.M. Number
F	88-94	NRR	All Models with O.E.M. Number
F	11-15	REACH	All Models with O.E.M. Number
F	99-04	UD 1200	All Models with O.E.M. Number
F	05-07	1300	All Models with O.E.M. Number
F	94-10	1400	All Models with O.E.M. Number
83518	W	141041 (1)/TR0027 (2)	
F	13-20	HINO 155	All Models with O.E.M. Number
F	21	195	
F	12-20	195	All Models with O.E.M. Number
83519	W	401011 (4)	
R	13-20	HINO 155	All Models with O.E.M. Number
R	21	195	
R	12-20	195	All Models with O.E.M. Number
83613	W	141083 (2)	
R	88-96	ISUZU FTR	All Models with O.E.M. Number
85000 Series			
85006	B	(cont)	
F	24	FORD F-59 COMMERCIAL STRIPPED CHASSIS	
F	11-23	F-59 COMMERCIAL STRIPPED CHASSIS	All MotorHomes with Ford F59 Commercial Chassis with 24,000 lb GVW to 26,000 lb GVW
F	95-05	FREIGHTLINER FL50	All Models with 10,000 to 18,000 lb Suspension
F		STERLING TRUCK ACTERRA	
85009	W	145054 (1)	
F	91-95	mitsubishi FUSO FK	All FK455 Models with 19mm Lower Mounting Pin, with OEM Number
F	91-95	FK	All FK457 Models with 19mm Lower Mounting Pin, with OEM Number
F	87-95	FK	All FK415 Models with 19mm Lower Mounting Pin, with OEM Number
F	95	FK	All FK190; 19mm Lower Mounting Pin, with OEM Number

Numerical listing

Shock	POP	Alternative No.	MTG Acc. Supplied
Pos.	Year	Application	
85009	W (cont)	145054 (1)	
F	88-90	FK All FK455 Models with O.E.M. Number	
85010	W		
R	11-21	FORD F-59 COMMERCIAL STRIPPED CHASSIS All F59 Commercial Chassis with 16,000 lb or 19,500 GVW	
R	89-97	F-59 COMMERCIAL STRIPPED CHASSIS All F59 Commercial Chassis with 16,000 lb or 19,500 GVW	
85012	B	145080 (2)	
R	85	ISUZU ADDITIONAL APPLICATIONS	
R	86-95	NPR All	
F	08-19	PETERBILT 325 All Models with 12000 lb Set Back Front Axle	
85013	C		
R	00-02	CHEVROLET T6500 All With Hendrickson Air Suspension	
R	00-02	T7500 All With Hendrickson Air Suspension	
F	11-21	FORD F-59 COMMERCIAL STRIPPED CHASSIS All F59 Commercial Chassis with 16,000 lb to 22,000 GVW	
F	89-97	F-59 COMMERCIAL STRIPPED CHASSIS All F59 Commercial Chassis with 16,000 lb to 22,000 GVW	
R	00-02	GMC T6500 All With Hendrickson Air Suspension	
85031	D	145147(1)/TR0027(2)	
F	08-21	KENWORTH T170 All Models with 8,000 lb Taper Leaf Front Springs	
F	08-10	T270 All Models with 12,000 lb Front Axle	
85043	W		
F	95-05	FREIGHTLINER FL50 All Models with 6000 to 9000 lb Front axle	
85058	C		
F	98-23	FREIGHTLINER MT45 All Step Van Models with O.E.M. Number MT55	
F			
85069	A	145089-000 (2)	
R	24	KENWORTH T270	
R	20-23	T270 All Models with Air Glide 400L (AG400L) Rear Air Suspension	
R	08-23	T270 All Models with AG210L Rear Air Suspension	
R	22-24	PETERBILT 536 All Models with Peterbilt Low Air Leaf Suspension	
85071	W	145054 (2)	
R	90-96	CHEVROLET C60 KODIAK All Conventional Cab w/15000, 19000, 21000 lb Multileaf Springs	
R	90-02	C4500 KODIAK	
R	03-09	C4500 KODIAK All C Chassis - Conventional Cab With 15000, 19000, 21000 lb Multileaf Springs	
R	92-02	C5500 KODIAK	
R	03-09	C5500 KODIAK All C Chassis - Conventional Cab With 15000, 19000, 21000 lb Multileaf Springs	
R	90-91	C5500 KODIAK All C Chassis - Conventional Cab With 15000, 19000, 21000 lb Multileaf Springs	
R	00-01	C7500 KODIAK All Conventional Cab w/15000, 19000, 21000 lb Multileaf Springs	
R	90-06	T5500	
R	03	T6500	
R	90-96	T6500	
R	04-05	T6500 All Tilt Cab w/15000, 19000, 21000 lb Multileaf Springs	
R	97-02	T6500 All Tilt Cab w/15000, 19000, 21000 lb Multileaf Springs	
R	04-05	T7500 All Tilt Cab w/15000, 19000, 21000 lb Multileaf Springs	
R	97-02	T7500 All Tilt Cab w/15000, 19000, 21000 lb Multileaf Springs	
R	04-05	T8500 All Tilt Cab w/15000, 19000, 21000 lb Multileaf Springs	
R	90-02	GMC C4500 TOPKICK	
R	03-09	C4500 TOPKICK All C Chassis - Conventional Cab with 15000, 19000, 21000 lb Multileaf Springs	

85000 Series

Shock	POP	Alternative No.	MTG Acc. Supplied
Pos.	Year	Application	
85071	W (cont)	145054 (2)	
R	90-02	C5500 TOPKICK	
R	03-09	C5500 TOPKICK All C Chassis - Conventional Cab with 15000, 19000, 21000 lb Multileaf Springs	
R	90-06	T5500	
R	03	T6500	
R	90-96	T6500	
R	04-05	T6500 All Tilt Cab with 15000, 19000, 21000 lb Multileaf Springs	
R	97-02	T6500 All Tilt Cab with 15000, 19000, 21000 lb Multileaf Springs	
F	18-20	ISUZU FTR All FTR Diesel Models with Std Cab	
R	90-09	FTR All Models with 15000, 19000, 21000 lb Multileaf Springs	
R	05-08	HVR All Conventional Cab W/15000, 19000, 21000lb Multi Leaf Springs	
85072	C		
R	08-22	KENWORTH T270 All Models with Hendrickson Primaax 230, 232, 460, 462, 690 and 692 Air Suspension (8-1/2" to 10" Ride Height)	
85084	C		
F	10-14	KENWORTH T270 All Models with 10,000 lb to 12,000 lb Front Axle	
F	10-14	T270 All Models with 13,200 lb to 14,600 lb Front Axle	
F	10-14	T270 All Models with 8,000 lb Front Axle	
F	08-15	PETERBILT 325 All Models with 8,000 lb Front Axle	
85106	W		
F	21-22	LION LION6 All Trucks with Hendrickson Softek Suspension (12,500 lb Capacity)	
85182	W	145089-200 (2)	
F	13-24	KENWORTH K270 All Models with 10,000 lb to 12,000 lb Front Axle	
85188	D		
R	23	MACK MD6	
R	24	MD6 All Models with O.E.M. Number	
R	21-22	MD6 All Models with O.E.M. Number	
85331	C		
R	02-10	FREIGHTLINER M2 100 All Models with Freightliner Low Profile Rear Air Suspension (18,000 to 40,000 lb)	
R	99-24	MT55 All Models with Freightliner Low Profile Rear Air Suspension	
85332	W	145128 (1)	
R	00-02	CHEVROLET T6500 All with 16,900lb Axle. Tapered Leaf Springs	
R	00-02	T7500 All with 16,900lb Axle. Tapered Leaf Springs	
R	00-02	GMC T6500 All with 16,900lb Axle. Tapered Leaf Springs	
85335	W		
R	02-10	FREIGHTLINER M2 100 All Models with Rear 10000 lb - 15000 lb Low Profile AirLiner	
85642	A		
R	19-22	INTERNATIONAL MV607 All Models with International 21,000 lb Rear Air Suspension	
85649	W	143146 (1)	
F	12-18	RAM 4500 All Models with O.E.M. Number	
F	12-18	5500 All Models with O.E.M. Number	
F	08-10	STERLING TRUCK BULLET 45 All Models with O.E.M. Number	
F	08-10	BULLET 55 All Models with O.E.M. Number	
85650	W		
R	12-18	RAM 4500 All Models with O.E.M. Number	
R	12-18	5500 All Models with O.E.M. Number	
R	08-10	STERLING TRUCK BULLET 45 All Models with O.E.M. Number	
R	08-10	BULLET 55 All Models with O.E.M. Number	

Numerical listing

Shock	POP	Alternative No.	MTG Acc. Supplied
Pos.	Year	Application	
85656	C		
R	16-19	INTERNATIONAL DURASTAR All Models with 20,000 lb International IROS Air Suspension	
R		DURASTAR - 4300, 4400 SERIES	
R	16-19	DURASTAR - 4300, 4400 SERIES	
R	25	MV60E All with IROS 20k Rear	
R	20-22	MV607 All Models with 20,000 lb International IROS Air Suspension	
85670	W		
R	25	CHEVROLET SILVERADO 4500HD	
R	19-24	SILVERADO 4500 HD All Models with IROS Rear	
R	25	SILVERADO 5500HD	
R	19-24	SILVERADO 5500 HD All Models with IROS Rear	
R	25	SILVERADO 6500HD	
R	19-24	SILVERADO 6500 HD All Models with IROS Rear	
85705	W	145090 (2)	
R	06-09	CHEVROLET T6500 All 15,000lb;17,000lb; 19,000lb; 21,000lb and 23,000lb Axle	
R	06-09	T7500 All 15,000lb;17,000lb; 19,000lb; 21,000lb and 23,000lb Axle	
R	06-09	T8500 All 15,000lb;17,000lb; 19,000lb; 21,000lb and 23,000lb Axle	
R	06-09	GMC T6500 All 15,000lb;17,000lb; 19,000lb; 21,000lb and 23,000lb Axle	
85724	A		
R	95-05	FREIGHTLINER FL50 All Models with FAS II (40,000 lb) Rear Air Suspension	
R	02-10	M2 100 All Models with FAS II (40,000 lb) Rear Air Suspension	
85910	W		
F		PETERBILT 330	
85919	A		
F	99-24	FREIGHTLINER MT55 All MT55 Chassis with O.E.M. Number	
85920	B		
F	01-09	STERLING TRUCK ACTERRA	
85921	W	145054 (1)	
R	02-10	FREIGHTLINER M2 100 All Models with Rear 60" Spring ,18000 lb - 23000 lb	
85923	D		
R		INTERNATIONAL DURASTAR - 4300, 4400 SERIES	
R	10-11	DURASTAR - 4300, 4400 SERIES	
85927	W		
R	02-10	INTERNATIONAL 4200 All with Tapered Rail, 5.6" Ride Height, W/IAS Suspension	
R		DURASTAR - 4300, 4400 SERIES	
85928	C		
F	02-10	INTERNATIONAL 4200 All With 10,000lb - 14,000lb Axle	
F	16-20	DURASTAR All Models with 11,000 lb to 14,000 lb Front axle	
F	16-20	DURASTAR - 4300, 4400 SERIES	
F	23	EMV607	
F	25	MV60E All Models with 11,000 lb to 14,000 lb Taper Leaf Springs	
F	19-22	MV607 All Models with 11,000 lb to 14,000 lb Taper-leaf Springs	
85956	C		
R	02-10	FREIGHTLINER M2 100 All Models with Freightliner TuffTrac Rear Air Suspension	
85957	D		
F	02-10	INTERNATIONAL 4200 All with 6,000lb - 8,000lb Axle	
F	12-18	8600 TRANSTAR All Models with 10,000 to 14,000 lb Front Axle	
F	15	DURASTAR All Models with 12,000 lb Front axle	
F	13	DURASTAR All Models with 12,000 lb Front axle	
F	10-15	DURASTAR - 4300, 4400 SERIES	

Numerical listing

Shock	POP	Alternative No.	MTG Acc. Supplied
Pos.	Year	Application	
85976	D		
R	00-14	INTERNATIONAL 5500I All Hendrickson HAS-402 Air Ride Suspension	
R	15-20	DURASTAR All Models with Hendrickson HAS - 230 or 460 Rear Air Suspension	
R	13	DURASTAR All Models with Hendrickson HAS - 230 or 460 Rear Air Suspension	
R	19-22	MV607 All Models with Hendrickson HAS - 230 or 460 Rear Air Suspension	
85979	W		
R	00-14	INTERNATIONAL 5500I All Hendrickson HAS-402 Air Ride Suspension	
85988	D		145099 (1)
R	22-24	PETERBILT 536 All Models with Air Trac Suspension (40,000 lb)	
85989	A		
F	15-22	KENWORTH T270 All Models with 10,000 lb to 14,600 lb Taperleaf Springs and Set Back Front Axles	
F	15-22	T270 All Models with 16,000 lb to 20,000 lb Taperleaf Springs and Set Back Front Axles	
F	24	T280 All Models with 10,000 lb to 12,000 lb Mono-leaf front springs	
F	22-24	PETERBILT 536 All Models with 10,000 lb to 14,600 lb Taperleaf Springs and Set Back Front Axles	
89000 Series			
89405	W		
R	13-24	KENWORTH K270 All Models with Hendrickson HAS - 210L or HAS - 230L Rear Air Suspension	
R	08-23	T270 All Models with Hendrickson HAS - 210L or HAS - 230L Rear Air Suspension	
89406	W		
R	00-01	CHEVROLET C7500 KODIAK All Models with Hendrickson Air Suspension (Stamping number 47902-13)	
R	99	T6500 All Models with Hendrickson Air Suspension (Stamping number 47902-13)	
R	99	T7500 All Models with Hendrickson Air Suspension (Stamping number 47902-13)	
R	04-09	T8500 All Models with Hendrickson Air Suspension (Stamping number 47902-13)	
R	99	GMC T5500	
R	99	T6500 All Models with Hendrickson Air Suspension (Stamping number 47902-13)	
R		ISUZU FVR	
89409	W		140149 (1)
F	80-86	FORD C600 All Models with 4040, 5040 lb Springs and 7000, 9000, 12000 lb Axles	
89413	W		145080 (2)
R	85	ISUZU ADDITIONAL APPLICATIONS	
R	86-95	NPR All	
F	08-19	PETERBILT 325 All Models with 12000 lb Set Back Front Axle	
89414	W		
F	11-21	FORD F-59 COMMERCIAL STRIPPED CHASSIS All F59 Commercial Chassis with 16,000 lb to 22,000 GVW	
F	89-97	F-59 COMMERCIAL STRIPPED CHASSIS All F59 Commercial Chassis with 16,000 lb to 22,000 GVW	
89425	W		401754 (4)
R	00-14	INTERNATIONAL 5500I All Chalmers 854-46	
89430	C		
F	05-10	HINO 145 All Models with O.E.M. Number	
F	05-10	165 All Models with O.E.M. Number	
F	05-10	185 All Models with O.E.M. Number	

85000 Series, 89000 Series, Steering Stabilizer

Shock	POP	Alternative No.	MTG Acc. Supplied
Pos.	Year	Application	
89430	C (cont)		
R	13-24	KENWORTH K270 All Models with Reyco 102 or 79KB Suspension (Drive Axle)	
R	08-22	T170 All Models with Reyco 79KB Rear Steel Spring Suspension	
R	08-23	T270 All Models with Reyco 102 or 79KB Suspension (Drive Axle)	
R	21-24	T280 All Models with Reyco 102 or 79KB Suspension (Drive Axle)	
R	08-15	PETERBILT 210 All Models with Reyco 102 or 79KB Suspension (Drive Axle)	
R	08-19	325 All Models with Reyco 102 or 79KB Suspension (Drive Axle)	
89431	W		
F	98-23	FREIGHTLINER MT45 All Step Van Models with O.E.M. Number MT55	
89443	C		
R	95-05	FREIGHTLINER FL50 All Models with FAS II (40,000 lb) Rear Air Suspension	
R	02-10	M2 100 All Models with FAS II (40,000 lb) Rear Air Suspension	
89455	C		141108 (1)
R	08-23	KENWORTH T270 All Models with AG210L Rear Air Suspension	
R	22-24	PETERBILT 536 All Models with Peterbilt Low Air Leaf Suspension	
89458	W		
R	08-11	INTERNATIONAL 8500 TRANSTAR All Models with International 40,000lb Rear Air Suspension	
R	08-18	8600 TRANSTAR All Models with International 40,000lb Rear Air Suspension	
R		DURASTAR - 4300, 4400 SERIES	
R	10-11	DURASTAR - 4300, 4400 SERIES	
89460	W		
F	10-14	KENWORTH T270 All Models with 10,000 lb to 12,000 lb Front Axle	
F	10-14	T270 All Models with 13,200 lb to 14,600 lb Front Axle	
F	10-14	T270 All Models with 8,000 lb Front Axle	
F	08-15	PETERBILT 325 All Models with 8,000 lb Front Axle	
89503	W		
F	01-09	STERLING TRUCK ACTERRA	
Steering Stabilizer			
6802SE	A		141998
F	82-86	CHEVROLET PICKUP 1 TON, C30 6.2L 8Cyl V (379), 3.98 101.0(Bore)3.82 97.0(Stroke) Single System Steering Stabilizer; w/ Cooler All models with factory frame bracket. Kit 143168 required to install to linkage.	
F	75-86	PICKUP 1 TON, C30 4.8L 6Cyl L (292), 3.88 98.4(Bore)4.13 104.8(Stroke) Single System Steering Stabilizer; w/ Cooler All models with factory frame bracket. Kit 143168 required to install to linkage.	
F	75-86	PICKUP 1 TON, C30 5.7L 8Cyl V (350), 4.00 101.6(Bore)3.48 88.5(Stroke) Single System Steering Stabilizer; w/ Cooler All models with factory frame bracket. Kit 143168 required to install to linkage.	
F	80	PICKUP 1 TON, C30 4.1L 6Cyl L (250), 3.68 93.5(Bore)3.91 99.3(Stroke) Single System Steering Stabilizer; w/ Cooler All models with factory frame bracket. Kit 143168 required to install to linkage.	
F	79	PICKUP 1 TON, C30 4.1L 6Cyl L (250) Single System Steering Stabilizer; w/ Cooler All models with factory frame bracket. Kit 143168 required to install to linkage.	

Numerical listing

Shock	POP	Alternative No.	MTG Acc. Supplied
Pos.	Year	Application	
6802SE	A (cont)		141998
F	76-78	PICKUP 1 TON, C30 6.6L 8Cyl V (400), 4.13 104.8(Bore)3.76 95.5(Stroke) Single System Steering Stabilizer; w/ Cooler All models with factory frame bracket. Kit 143168 required to install to linkage.	
F	78	PICKUP 1 TON, C30 4.1L 6Cyl L (250), 3.68 93.5(Bore)3.91 99.3(Stroke) Single System Steering Stabilizer; w/ Cooler All models with factory frame bracket. Kit 143168 required to install to linkage.	
F	78	PICKUP 1 TON, C30 5.0L 8Cyl V (305), 3.74 94.9(Bore)3.48 88.4(Stroke) Single System Steering Stabilizer; w/ Cooler All models with factory frame bracket. Kit 143168 required to install to linkage.	
F	75	PICKUP 1 TON, C30 4.1L 6Cyl L (250), 3.68 93.5(Bore)3.91 99.3(Stroke) Single System Steering Stabilizer; w/ Cooler All models with factory frame bracket. Kit 143168 required to install to linkage.	
F	73-74	PICKUP 1 TON, C30 All Single System Steering Stabilizer; w/ Cooler All models with factory frame bracket. Kit 143168 required to install to linkage.	
F	61-72	PICKUP 1 TON, C30 All Single System Steering Stabilizer All models with factory frame bracket. Kit 143168 required to install to linkage.	
F	77-86	PICKUP 1 TON, K30 All Dual System Steering Stabilizer All models with factory frame bracket. Kit 143168 required to install to linkage.	
F	87-88	PICKUP 1 TON, R30 4.8L 6Cyl L (292), 3.88 98.4(Bore)4.13 104.8(Stroke) Single System Steering Stabilizer; w/ Cooler All models with factory frame bracket. Kit 143168 required to install to linkage.	
F	87-88	PICKUP 1 TON, R30 5.7L 8Cyl V (350), 4.00 101.6(Bore)3.48 88.5(Stroke) Single System Steering Stabilizer; w/ Cooler All models with factory frame bracket. Kit 143168 required to install to linkage.	
F	87-88	PICKUP 1 TON, R30 6.2L 8Cyl V (379), 3.98 101.0(Bore)3.82 97.0(Stroke) Single System Steering Stabilizer; w/ Cooler All models with factory frame bracket. Kit 143168 required to install to linkage.	
F	89-91	PICKUP 1 TON, R3500 5.7L 8Cyl V (350), 4.00 101.6(Bore)3.48 88.5(Stroke) Single System Steering Stabilizer; w/ Cooler All models with factory frame bracket. Kit 143168 required to install to linkage.	
F	63-86	PICKUP 3/4 TON, C20 All Single System Steering Stabilizer All models with factory frame bracket. Kit 143168 required to install to linkage.	
F	67-86	PICKUP 3/4 TON, K20 All Dual System Steering Stabilizer All models with factory frame bracket. Kit 143168 required to install to linkage.	
F	87-88	PICKUP 3/4 TON, R20 All Single System Steering Stabilizer All models with factory frame bracket. Kit 143168 required to install to linkage.	
F	89	PICKUP 3/4 TON, R2500 All Single System Steering Stabilizer All models with factory frame bracket. Kit 143168 required to install to linkage.	
F	87	PICKUP 3/4 TON, V20 All Dual System Steering Stabilizer All models with factory frame bracket. Kit 143168 required to install to linkage.	
F	70-95	VAN 1/2 TON, G / EXPRESS All Single System Steering Stabilizer All models with factory frame bracket. Kit 143168 required to install to linkage.	

Numerical listing

Shock	POP	Alternative No.	MTG Acc. Supplied
Pos.	Year	Application	
6802SE	A (cont)	141998	
F	71-95	VAN 1 TON, G / EXPRESS All Single System Steering Stabilizer All models with factory frame bracket. Kit 143168 required to install to linkage.	
F	70-95	VAN 3/4 TON, G / EXPRESS All Single System Steering Stabilizer All models with factory frame bracket. Kit 143168 required to install to linkage.	
F	75-93	DODGE PICKUP 1 TON, D300 SERIES All Single System Steering Stabilizer All models with factory frame bracket. Kit 143168 required to install to linkage.	
F	72-74	PICKUP 1 TON, D300 SERIES All Single System Steering Stabilizer; w/ Coil Spring Front Suspension All models with factory frame bracket. Kit 143168 required to install to linkage.	
F	60-71	PICKUP 1 TON, D300 SERIES All Single System Steering Stabilizer; w/ I-Beam Axle All models with factory frame bracket. Kit 143168 required to install to linkage.	
F	90-93	PICKUP 1 TON, W300 SERIES All Single System Steering Stabilizer All models with factory frame bracket. Kit 143168 required to install to linkage.	
F	60-86	PICKUP 1 TON, W300 SERIES All Dual System Steering Stabilizer; Exc. Vacuum Servo Mounted on Drivers Side of Axle All models with factory frame bracket. Kit 143168 required to install to linkage.	
F	73-93	PICKUP 3/4 TON, D200 SERIES All Single System Steering Stabilizer All models with factory frame bracket. Kit 143168 required to install to linkage.	
F	60-71	PICKUP 3/4 TON, D200 SERIES All Single System Steering Stabilizer; w/ I-Beam Axle All models with factory frame bracket. Kit 143168 required to install to linkage.	
F	90-93	PICKUP 3/4 TON, W200 SERIES All Single System Steering Stabilizer All models with factory frame bracket. Kit 143168 required to install to linkage.	
F	60-86	PICKUP 3/4 TON, W200 SERIES All Dual System Steering Stabilizer; Exc. Vacuum Servo Mounted on Drivers Side of Axle All models with factory frame bracket. Kit 143168 required to install to linkage.	
F	71	VAN 1/2 TON, A / B SERIES / RAM All Single System Steering Stabilizer; w/ I-Beam Axle Applications with OEM mounting hardware	
F	71	VAN 1 TON, A / B SERIES / RAM All Single System Steering Stabilizer; w/ I-Beam Axle Applications with OEM mounting hardware	
F	71	VAN 3/4 TON, A / B SERIES / RAM All Single System Steering Stabilizer; w/ I-Beam Axle Applications with OEM mounting hardware	
F	61-67	FORD ECONOLINE VAN Single System Steering Stabilizer All models with factory frame bracket. Kit 143168 required to install to linkage.	
F	92-97	PICKUP 1 TON, F-350 / SUPERDUTY RWD Dual System Steering Stabilizer All models with factory frame bracket. Kit 143168 required to install to linkage.	
F	89-91	PICKUP 1 TON, F-350 / SUPERDUTY RWD Single System Steering Stabilizer All models with factory frame bracket. Kit 143168 required to install to linkage.	
F	82-88	PICKUP 1 TON, F-350 / SUPERDUTY RWD Single System Steering Stabilizer; Exc. Anti-Sway Bar All models with factory frame bracket. Kit 143168 required to install to linkage.	

Steering Stabilizer

Shock	POP	Alternative No.	MTG Acc. Supplied
Pos.	Year	Application	
6802SE	A (cont)	141998	
F	79-81	PICKUP 1 TON, F-350 / SUPERDUTY RWD Dual System Steering Stabilizer All models with factory frame bracket. Kit 143168 required to install to linkage.	
F	75-78	PICKUP 1 TON, F-350 / SUPERDUTY All Dual System Steering Stabilizer All models with factory frame bracket. Kit 143168 required to install to linkage.	
F	65-74	PICKUP 1 TON, F-350 / SUPERDUTY All Single System Steering Stabilizer; w/ Twin I Beam Axle All models with factory frame bracket. Kit 143168 required to install to linkage.	
F	60-64	PICKUP 1 TON, F-350 / SUPERDUTY All Single System Steering Stabilizer w/ I Beam Axle All models with factory frame bracket. Kit 143168 required to install to linkage.	
F	65-67	PICKUP P100 All Single System Steering Stabilizer All models with factory frame bracket. Kit 143168 required to install to linkage.	
F	68-73	PICKUP P350 All Single System Steering Stabilizer All models with factory frame bracket. Kit 143168 required to install to linkage.	
F	69-74	VAN 3/4 TON, ECONOLINE / CLUB WAGON / SUPERDUTY All Single System Steering Stabilizer; w/ Twin I-Beam Axle All models with factory frame bracket. Kit 143168 required to install to linkage.	
F	75-86	GMC PICKUP 1 TON, C35/3500 Crew Cab Pickup Single System Steering Stabilizer All models with factory frame bracket. Kit 143168 required to install to linkage.	
F	72-74	PICKUP 1 TON, C35/3500 All Single System Steering Stabilizer All models with factory frame bracket. Kit 143168 required to install to linkage.	
F	67-86	PICKUP 3/4 TON, C25 / C2500 All Single System Steering Stabilizer All models with factory frame bracket. Kit 143168 required to install to linkage.	
F	67-86	PICKUP 3/4 TON, K25 / K2500 All Dual System Steering Stabilizer All models with factory frame bracket. Kit 143168 required to install to linkage.	
F	87-89	PICKUP 3/4 TON, R2500 All Single System Steering Stabilizer All models with factory frame bracket. Kit 143168 required to install to linkage.	
F	87	PICKUP 3/4 TON, V2500 All AN49 All models with factory frame bracket. Kit 143168 required to install to linkage.	
F	70-95	VAN 1/2 TON, G / SAVANA All Single System Steering Stabilizer All models with factory frame bracket. Kit 143168 required to install to linkage.	
F	71-95	VAN 1 TON, G / SAVANA All Single System Steering Stabilizer All models with factory frame bracket. Kit 143168 required to install to linkage.	
F	70-95	VAN 3/4 TON, G / SAVANA All Single System Steering Stabilizer All models with factory frame bracket. Kit 143168 required to install to linkage.	
F	69-70	INTERNATIONAL 1200D All Single System Steering Stabilizer; 1/2 Ton, 3/4 Ton & Travelall All models with factory frame bracket. Kit 143168 required to install to linkage.	
F	69-70	1300D All Single System Steering Stabilizer; 1/2 Ton, 3/4 Ton & Travelall All models with factory frame bracket. Kit 143168 required to install to linkage.	

Numerical listing

Shock	POP	Alternative No.	MTG Acc. Supplied
Pos.	Year	Application	
6802SE	A (cont)	141998	
F	68-72	M1100 / M1200 All Single System Steering Stabilizer; 1/2 and 3/4 Ton I-Beam Axle All models with factory frame bracket. Kit 143168 required to install to linkage.	
F	69	M1400 All Single System Steering Stabilizer; 1/2 and 3/4 Ton I-Beam Axle All models with factory frame bracket. Kit 143168 required to install to linkage.	
6803SE	D	141998	
F	61-72	CHEVROLET PICKUP 3/4 TON, K20 All Single System Steering Stabilizer	
F	01-09	PICKUP 3/4 TON, SILVERADO 2500 HD All 9200# GVW w/o OE Unit - 15059138 15155638	
F	60-89	DODGE PICKUP 1 TON, W300 SERIES All Single System Steering Stabilizer	
F	69-89	PICKUP 3/4 TON, W200 SERIES All Single System Steering Stabilizer	
F	60-67	PICKUP 3/4 TON, W200 SERIES All Single System Steering Stabilizer	
F	71-87	VAN 1/2 TON, A / B SERIES / RAM All Single System Steering Stabilizer	
F	71-87	VAN 1 TON, A / B SERIES / RAM All Single System Steering Stabilizer	
F	80-87	VAN 3/4 TON, A / B SERIES / RAM All Single System Steering Stabilizer	
F	78-79	VAN 3/4 TON, A / B SERIES / RAM All Van Charger Special	
F	71-77	VAN 3/4 TON, A / B SERIES / RAM All Single System Steering Stabilizer	
F	75-77	FORD PICKUP 1 TON, F-350 / SUPERDUTY Manual Steering Single System Steering Stabilizer	
F	60-74	PICKUP 1 TON, F-350 / SUPERDUTY All Single System Steering Stabilizer	
F	74-79	VAN 3/4 TON, ECONOLINE / CLUB WAGON / SUPERDUTY All QuadraVan Special	
F	67-72	GMC PICKUP 3/4 TON, K25 / K2500 All Single System Steering Stabilizer	
6804SE	B	500498,141397	
F	77-86	CHEVROLET PICKUP 1 TON, K30 All Single System Steering Stabilizer	
F	73-86	PICKUP 3/4 TON, K20 All Single System Steering Stabilizer	
F	87	PICKUP 3/4 TON, V20 All Single System Steering Stabilizer	
F	94-95	VAN 1 TON, G / EXPRESS All Single System Steering Stabilizer; HD w/ Straight Front Axle & Tilt Hood	
F	85-93	VAN 1 TON, P SERIES All Single System Steering Stabilizer; w/ I-Beam Front Suspension	
F	94-97	DODGE PICKUP 1 TON, RAM 3500 (SEE RAM 3500) 4WD With OEM 52038276	
F	94-97	PICKUP 1 TON, RAM 3500 (SEE RAM 3500) RWD w/ OEM 52038276 Solid Front Axle	
F	94-97	PICKUP 3/4 TON, RAM 2500 (SEE RAM 2500) 4WD With OEM 52038276	
F	73-86	GMC PICKUP 3/4 TON, K25 / K2500 All Single System Steering Stabilizer	
F	87	PICKUP 3/4 TON, V2500 All Single System Steering Stabilizer	
F	94-95	VAN 1 TON, G / SAVANA All Single System Steering Stabilizer; HD w/ Straight Front Axle & Tilt Hood	
6828SE	D	142718	
F	00-02	FORD E-450 ECONOLINE SUPER DUTY All Single System Steering Stabilizer	
F	02	E-550 ECONOLINE SUPER DUTY All Single System Steering Stabilizer	
F	03	E-550 SUPER DUTY All Single System Steering Stabilizer	
F	96-99	ECONOLINE SUPER DUTY All Single System Steering Stabilizer	
F	99-10	PICKUP 1 TON, F-350 / SUPERDUTY RWD Single System Steering Stabilizer	
F	92-97	PICKUP 1 TON, F-350 / SUPERDUTY RWD Single System Steering Stabilizer	

Numerical listing

Steering Stabilizer, Ultra Struts, Ultra ReadyMount, Ultra Truck Shock

Numerical listing

Shock	POP	Alternative No.	MTG Acc. Supplied
Pos.	Year	Application	
6828SE	D	(cont)	142718
F	99-10	PICKUP 3/4 TON, F-250 / SUPERDUTY RWD Single System Steering Stabilizer	
F	21-24	VAN 1 TON, ECONOLINE / CLUB WAGON / SUPERDUTY All Single System Steering Stabilizer	
F	92-19	VAN 1 TON, ECONOLINE / CLUB WAGON / SUPERDUTY All Single System Steering Stabilizer	
F	96-04	VAN 3/4 TON, ECONOLINE / CLUB WAGON / SUPERDUTY All Single System Steering Stabilizer	
6847SE	D		143081
F	00-07	DODGE PICKUP 1 TON, RAM 3500 (SEE RAM 3500) 4WD With OEM # 52106909AB, AC, AD	
F	00-07	PICKUP 1 TON, RAM 3500 (SEE RAM 3500) RWD With OEM # 52106909AB, AC, AD and Solid Front Axle	
F	00-07	PICKUP 3/4 TON, RAM 2500 (SEE RAM 2500) 4WD With OEM # 52106909AB, AC, AD	
6850SE	D		143168
F	99-04	FORD PICKUP 1 TON, F-350 / SUPERDUTY 4WD Exc. OE Unit	
F	99-04	PICKUP 3/4 TON, F-250 / SUPERDUTY 4WD Exc. OE Unit	
6853SE	A		143155
F	95-00	CHEVROLET PICKUP 1 TON, K35 / K3500 All Exc. OE Unit	
F	92-99	PICKUP 3/4 TON, C25 / C2500 All Exc. OE Unit	
F	99-00	PICKUP 3/4 TON, K25 / K2500 All Exc. OE Unit	
F	01-09	PICKUP 3/4 TON, SILVERADO 2500 HD 4WD 9200# GVW w/ OE Unit - 15059138 15155638	
F	99-00	GMC PICKUP 3/4 TON, K25 / K2500 4WD 9200# GVW w/ OE Unit - 15059138 15155638	
F	99-04	SIERRA 2500 4WD Single System Steering Stabilizer; Up through 8600# GVW; Exc. OE Steering Stabilizer	
F	01-09	SIERRA 2500 HD 4WD 9200# GVW w/ OE Unit - 15059138 15155638	
6854SE	D		142718
F	00-05	FORD EXCURSION 4WD With OE Unit	
F	99-03	PICKUP 1 TON, F-350 / SUPERDUTY 4WD With OE Unit	
F	99-03	PICKUP 3/4 TON, F-250 / SUPERDUTY 4WD With OE Unit	
F	99-04	PICKUP, F-450 SUPERDUTY 4 X 4 Single System Steering Stabilizer	
F	99-04	PICKUP, F-550 SUPERDUTY 4 X 4 Single System Steering Stabilizer	
6855SE	C		143154
F	99-04	FORD PICKUP 1 TON, F-350 / SUPERDUTY 4WD Replacement Kit	
F	99-04	PICKUP 3/4 TON, F-250 / SUPERDUTY 4WD Replacement Kit	
6856SE	W		143156.00
F	05-07	FORD PICKUP 3/4 TON, F-250 / SUPERDUTY 4WD Exc. OE Unit	
Ultra Struts			
G56778	W		
F	03-06	DODGE SPRINTER 2500 All	
F	03-06	SPRINTER 3500 All	
F	02-06	FREIGHTLINER SPRINTER 2500 All	
F	04-06	MERCEDES-BENZ SPRINTER All	
Ultra ReadyMount			
G57206	C		
F	12-15	RAM C/V All	
G57800	B		
F	14-25	RAM PROMASTER 1500 All Left	
F	14-25	PROMASTER 2500 All Left	
F	14-25	PROMASTER 3500 All Left	
F	26	THOR MOTOR COACH RIZE 18M Left Ram Promaster with OEM #6815 7795AE Strut	

Shock	POP	Alternative No.	MTG Acc. Supplied
Pos.	Year	Application	
G57801	B		
F	14-25	RAM PROMASTER 1500 All Right	
F	14-25	PROMASTER 2500 All Right	
F	14-25	PROMASTER 3500 All Right	
F	26	THOR MOTOR COACH RIZE 18M Right Ram Promaster with OEM #6815 7795AE Strut	
G57802	C		
F	07-09	DODGE SPRINTER 2500 All	
F	07-09	SPRINTER 3500 All	
F	07-18	FREIGHTLINER SPRINTER 2500 All	
F	07-18	SPRINTER 3500 All	
F	10-18	MERCEDES-BENZ SPRINTER 2500 All	
F	10-18	SPRINTER 3500 All	
G57816	C		
F	15-22	FORD TRANSIT-150 All	
F	15-22	TRANSIT-250 All	
F	15-22	TRANSIT-350 All	
G57852	W		
F	15-21	RAM PROMASTER CITY All Left	
G57853	W		
F	15-21	RAM PROMASTER CITY All Right	
Ultra Truck Shock			
G63183	D		
F	81-93	DODGE PICKUP 1 TON, W300 SERIES All Exc. Quad Suspension and Lift Kit	
F	61-80	PICKUP 1 TON, W300 SERIES All	
R	61-71	PICKUP 1 TON, W300 SERIES All	
F	90-93	PICKUP 3/4 TON, W200 SERIES Extended Cab Pickup Exc. Lift Kit	
F	88-93	PICKUP 3/4 TON, W200 SERIES Cab & Chassis Exc. Lift Kit	
F	81-93	PICKUP 3/4 TON, W200 SERIES Standard Cab Pickup Exc. Lift Kit	
F	86	PICKUP 3/4 TON, W200 SERIES Cab & Chassis Exc. Lift Kit	
F	81-83	PICKUP 3/4 TON, W200 SERIES Cab & Chassis Exc. Lift Kit	
F	81-82	PICKUP 3/4 TON, W200 SERIES Extended Cab Pickup Exc. Lift Kit	
F	69-80	PICKUP 3/4 TON, W200 SERIES All	
F	61-67	PICKUP 3/4 TON, W200 SERIES All	
G63299	A		140885
R	61-67	FORD ECONOLINE All	
R	00-01	MITSUBISHI CANTER 35	
R	00-05	55	
R	01-05	60	
R	01-05	75	
R	01-19	FB SERIES	
R	93-99	FB SERIES	
R	84-20	FE SERIES	
R	05-13	MITSUBISHI FUSO FE	
R	85-86	FE	
R	01-04	FE All FE7 & FE8 Series; Model with O.E.M. Number	
R	87-04	FE All Model with O.E.M. Number	
R	89-97	FE All FE335EV Series; Model with O.E.M. Number	
R	92-93	FE All FE337EV Series; Model with O.E.M. Number	
R	87-89	FE All FE435 Series; Model with O.E.M. Number	
G63306	C		
R	67	CHEVROLET K20 PANEL All	
R	67-72	PICKUP 1 TON, C30 All Exc. 11,000# Rear Axle	
R	63-72	PICKUP 3/4 TON, C20 All	
R	67-72	PICKUP 3/4 TON, K20 All	
R	67-77	VAN 1/2 TON, G / EXPRESS All	
R	63-66	VAN 1/2 TON, P SERIES All	
R	76-77	VAN 1 TON, G / EXPRESS All	
R	75	VAN 1 TON, G / EXPRESS 110.0 / 279.4 (WheelBase)	
R	75	VAN 1 TON, G / EXPRESS 125.0 / 317.5 (WheelBase)	
R	71-74	VAN 1 TON, G / EXPRESS All	
R	68-72	VAN 1 TON, P SERIES All Exc. 11,000# Rear Axle	
R	67-77	VAN 3/4 TON, G / EXPRESS All	
R	68-72	VAN 3/4 TON, P SERIES All	
R	67-72	GMC PICKUP 1 TON, C35/3500 All Exc. 11,000# Rear Axle	
R	72	PICKUP 3/4 TON, C25 / C2500 All Leaf(RearSpringType)	
R	71	PICKUP 3/4 TON, C25 / C2500 All	

Shock	POP	Alternative No.	MTG Acc. Supplied
Pos.	Year	Application	
G63306	C	(cont)	
R	67-70	PICKUP 3/4 TON, C25 / C2500 All Leaf(RearSpringType)	
R	67-77	VAN 1/2 TON, G / SAVANA All	
R	67	VAN 1/2 TON, P SERIES All	
R	76-77	VAN 1 TON, G / SAVANA All	
R	75	VAN 1 TON, G / SAVANA 110.0 / 279.4 (WheelBase)	
R	75	VAN 1 TON, G / SAVANA 125.0 / 317.5 (WheelBase)	
R	71-74	VAN 1 TON, G / SAVANA All	
R	68-72	VAN 1 TON, P SERIES All Exc. 11,000# Rear Axle	
R	67-77	VAN 3/4 TON, G / SAVANA All	
R	68-72	VAN 3/4 TON, P SERIES All	
R	63-65	VAN, PB 1000 SERIES All	
G63347	A		
F	69-86	CHEVROLET PICKUP 3/4 TON, K20 All Exc. Lift Kit	
F	87	PICKUP 3/4 TON, V20 All Exc. Quad Suspension and Lift Kit	
F	69-86	GMC PICKUP 3/4 TON, K25 / K2500 All Exc. Quad Suspension and Lift Kit	
F	87	PICKUP 3/4 TON, V2500 All Exc. Lift Kit	
G63349	A		140357
R	75-86	CHEVROLET PICKUP 3/4 TON, C20 Standard Cab Pickup	
R	75-86	PICKUP 3/4 TON, K20 All Exc. Lift Kit	
R	87	PICKUP 3/4 TON, R20 Standard Cab Pickup	
R	87	PICKUP 3/4 TON, V20 All Exc. Quad Suspension and Lift Kit	
R	73	VAN 1/2 TON, P SERIES All	
R	73-78	VAN 3/4 TON, P SERIES All	
R	75-86	GMC PICKUP 3/4 TON, C25 / C2500 Cab & Chassis	
R	75-86	PICKUP 3/4 TON, C25 / C2500 Standard Cab Pickup	
R	73-74	PICKUP 3/4 TON, C25 / C2500 All Exc. Crew Cab & Bonus Cab	
R	73-86	PICKUP 3/4 TON, K25 / K2500 All Exc. Lift Kit	
R	88-89	PICKUP 3/4 TON, R2500 All Exc. Crew Cab & Bonus Cab	
R	87	PICKUP 3/4 TON, R2500 Cab & Chassis Exc. Crew Cab & Bonus Cab	
R	87	PICKUP 3/4 TON, R2500 Standard Cab Pickup Exc. Crew Cab & Bonus Cab	
R	87	PICKUP 3/4 TON, V2500 All Exc. Lift Kit	
R	73	VAN 1/2 TON, P SERIES All	
R	73-78	VAN 3/4 TON, P SERIES All	
G63350	C		140126
R	75-79	FORD PICKUP 1 TON, F-350 / SUPERDUTY Extended Cab Pickup, RWD	
R	67-74	PICKUP 1 TON, F-350 / SUPERDUTY RWD Supercab	
G63353	C		
R	72-93	DODGE PICKUP 1 TON, D300 SERIES All	
R	72-93	PICKUP 3/4 TON, D200 SERIES All	
G63355	A		140702
F	63-86	CHEVROLET PICKUP 1 TON, C30 All	
F	88-91	PICKUP 1 TON, C35/3500 Cab & Chassis Exc. HD Solid Front Axle	
F	87-88	PICKUP 1 TON, R30 All	
F	89	PICKUP 1 TON, R3500 Standard Cab Pickup	
F	63-86	PICKUP 3/4 TON, C20 All	
F	87-88	PICKUP 3/4 TON, R20 All	
F	89	PICKUP 3/4 TON, R2500 All	
F	63-80	VAN 1/2 TON, P SERIES All	
F	68-90	VAN 1 TON, P SERIES All Cutaway Chassis	
F	68-89	VAN 3/4 TON, P SERIES All	
F	88-90	GMC PICKUP 1 TON, C35/3500 Cab & Chassis Exc. HD Solid Front Axle	
F	67-78	PICKUP 1 TON, C35/3500 All	
F	87-91	PICKUP 1 TON, R3500 All	
F	85-86	PICKUP 3/4 TON, C25 / C2500 Crew Cab Pickup	
F	75-86	PICKUP 3/4 TON, C25 / C2500 Cab & Chassis	

Numerical listing

Shock	POP	Alternative No.	MTG Acc. Supplied
Pos.	Year	Application	
G63355	A	(cont)	140702
F	75-86	PICKUP 3/4 TON, C25 / C2500 Standard Cab Pickup	
F	75-83	PICKUP 3/4 TON, C25 / C2500 Crew Cab Pickup	
F	67-74	PICKUP 3/4 TON, C25 / C2500 All	
F	87-89	PICKUP 3/4 TON, R2500 All Exc. Crew Cab & Bonus Cab	
F	66	PICKUP 2500 SERIES All	
F	67-80	VAN 1/2 TON, P SERIES All	
F	75-90	VAN 1 TON, P SERIES All Cutaway Chassis	
F	73-74	VAN 1 TON, P SERIES Base Cutaway Chassis	
F	68-72	VAN 1 TON, P SERIES All	
F	68-89	VAN 3/4 TON, P SERIES All	
F	63-65	VAN, PB 1000 SERIES All	
G63357	A		
F	71-95	CHEVROLET VAN 1/2 TON, G / EXPRESS All	
F	70	VAN 1/2 TON, G / EXPRESS All Independent Front Suspension	
F	76-96	VAN 1 TON, G / EXPRESS All	
F	75	VAN 1 TON, G / EXPRESS 146.0 / 370.8 (WheelBase)	
F	71-74	VAN 1 TON, G / EXPRESS All	
F	71-95	VAN 3/4 TON, G / EXPRESS All	
F	70	VAN 3/4 TON, G / EXPRESS All Independent Front Suspension	
F	71-95	GMC VAN 1/2 TON, G / SAVANA All	
F	70	VAN 1/2 TON, G / SAVANA All Independent Front Suspension	
F	76-95	VAN 1 TON, G / SAVANA All	
F	75	VAN 1 TON, G / SAVANA 146.0 / 370.8 (WheelBase)	
F	71-74	VAN 1 TON, G / SAVANA All	
F	78-95	VAN 3/4 TON, G / SAVANA All Exc. 8600# GVW	
F	71-77	VAN 3/4 TON, G / SAVANA All	
F	70	VAN 3/4 TON, G / SAVANA All Independent Front Suspension	
G63359	B		140126
F	72-93	DODGE PICKUP 3/4 TON, D200 SERIES All Exc. Heavy Duty Package	
F	99-03	VAN 1/2 TON, A / B SERIES / RAM 109.3 / 277.6 (WheelBase) Exc. 7000# GVW	
F	81-98	VAN 1/2 TON, A / B SERIES / RAM 109.6 / 278.4 (WheelBase) Exc. 7000# GVW	
F	71-80	VAN 1/2 TON, A / B SERIES / RAM All Exc. 4000# Front Axle	
F	95-03	VAN 1 TON, A / B SERIES / RAM All	
F	71-94	VAN 1 TON, A / B SERIES / RAM All Exc. 4000# Front Axle	
F	81-03	VAN 3/4 TON, A / B SERIES / RAM All	
F	71-80	VAN 3/4 TON, A / B SERIES / RAM All Exc. 4000# Front Axle	
F	74-80	VAN, CB300 All Exc. 4000# Front Axle	
F	81-83	PLYMOUTH VAN 1/2 TON, PB SERIES All	
F	74-83	VAN 1 TON, PB SERIES All Exc. 4000# Front Axle	
F	74-83	VAN 3/4 TON, PB SERIES All	
G63360	D		140126
F	72-93	DODGE PICKUP 1 TON, D300 SERIES All Heavy Duty Package	
F	72-93	PICKUP 3/4 TON, D200 SERIES All Heavy Duty Package	
F	71-93	VAN 1 TON, A / B SERIES / RAM All 4000# Front Axle	
F	74-80	VAN, CB300 All 4000# Front Axle	
F	74-83	PLYMOUTH VAN 1 TON, PB SERIES All 4000# Front Axle	
G63366	A		
R	75-86	CHEVROLET PICKUP 1 TON, C30 All	
R	88-91	PICKUP 1 TON, C35/3500 Cab & Chassis Exc. HD Solid Front Axle	
R	87-88	PICKUP 1 TON, R30 All	
R	89	PICKUP 1 TON, R3500 Standard Cab Pickup	
R	75-86	PICKUP 3/4 TON, C20 Crew Cab Pickup	
R	87-88	PICKUP 3/4 TON, R20 Crew Cab Pickup	
R	89	PICKUP 3/4 TON, R2500 All	
R	74-80	VAN 1/2 TON, P SERIES All	
R	73-99	VAN 1 TON, P SERIES All	

Ultra Truck Shock

Shock	POP	Alternative No.	MTG Acc. Supplied
Pos.	Year	Application	
G63366	A	(cont)	
R	79-89	VAN 3/4 TON, P SERIES All	
R	88-91	GMC PICKUP 1 TON, C35/3500 Cab & Chassis Exc. HD Solid Front Axle	
R	73-78	PICKUP 1 TON, C35/3500 All	
R	87-91	PICKUP 1 TON, R3500 All	
R	85-86	PICKUP 3/4 TON, C25 / C2500 Crew Cab Pickup	
R	75-83	PICKUP 3/4 TON, C25 / C2500 Crew Cab Pickup	
R	73-74	PICKUP 3/4 TON, C25 / C2500 All Crew Cab	
R	87-89	PICKUP 3/4 TON, R2500 Crew Cab Pickup	
R	74-80	VAN 1/2 TON, P SERIES All	
R	73-99	VAN 1 TON, P SERIES All	
R	79-89	VAN 3/4 TON, P SERIES All	
G63375	A		140780,142615
F	96-02	CHEVROLET VAN 1 TON, G / EXPRESS All	
F	96-02	VAN 3/4 TON, G / EXPRESS All Exc. 8600# GVW	
F	96-02	GMC VAN 1/2 TON, G / SAVANA RWD	
F	96-02	VAN 1 TON, G / SAVANA All	
F	96-02	VAN 3/4 TON, G / SAVANA All Exc. 8600# GVW	
G63377	C		141137
R	75-79	FORD PICKUP 1 TON, F-350 / SUPERDUTY Standard Cab Pickup, RWD	
R	73-74	PICKUP 1 TON, F-350 / SUPERDUTY All RWD; Supercab	
R	69-74	VAN 1 TON, ECONOLINE / CLUB WAGON / SUPERDUTY All	
R	69-74	VAN 3/4 TON, ECONOLINE / CLUB WAGON / SUPERDUTY All	
G63386	B		140780
F	75-79	FORD PICKUP 1 TON, F-350 / SUPERDUTY RWD RWD, 4WD Quad Suspension Rearward of Front Axle, Non Quad Suspension	
F	67-74	PICKUP 1 TON, F-350 / SUPERDUTY All RWD, 4WD Quad Suspension Rearward of Front Axle, Non Quad Suspension	
F	75-91	VAN 1 TON, ECONOLINE / CLUB WAGON / SUPERDUTY All Cutaway Chassis RWD, 4WD Quad Suspension Rearward of Front Axle, Non Quad Suspension	
F	75-91	VAN 3/4 TON, ECONOLINE / CLUB WAGON / SUPERDUTY All RWD, 4WD Quad Suspension Rearward of Front Axle, Non Quad Suspension	
G63387	D		140126
R	79	FORD PICKUP 1 TON, F-350 / SUPERDUTY 4WD	
R	75-91	VAN 1 TON, ECONOLINE / CLUB WAGON / SUPERDUTY All Cutaway Chassis	
R	75-91	VAN 3/4 TON, ECONOLINE / CLUB WAGON / SUPERDUTY All	
G63394	D		140702
F	85-99	CHEVROLET VAN 1 TON, P SERIES All Motorhome Chassis w/ Independent Front Suspension	
F	74-84	VAN 1 TON, P SERIES All Motorhome Chassis	
F	85-99	GMC VAN 1 TON, P SERIES All Motorhome Chassis w/ Independent Front Suspension	
F	75-84	VAN 1 TON, P SERIES All Motorhome Chassis	
F	74	VAN 1 TON, P SERIES Motorhome	
G63403	B		
R	79-91	CHEVROLET VAN 1 TON, G / EXPRESS All 9200# GVW	
F	85	VAN 1 TON, P SERIES All Motorhome Chassis w/ I-Beam Front Suspension	
R	93-96	GMC VAN 1 TON, G / SAVANA Cutaway Van 9200# GVW	
R	79-91	VAN 1 TON, G / SAVANA Cutaway Van 9200# GVW	
F	85	VAN 1 TON, P SERIES All Motorhome Chassis w/ I-Beam Front Suspension	

Numerical listing

Shock	POP	Alternative No.	MTG Acc. Supplied
Pos.	Year	Application	
G63405	A		140884
R	61-66	FORD PICKUP 1 TON, F-350 / SUPERDUTY All	
F	68-76	PICKUP P350 All Up through 8000# GVW	
F	75-76	PICKUP P400 All Up through 8000# GVW	
R	68-72	INTERNATIONAL M1100 / M1200 All	
R	69	M1400 All	
F	04-13	mitsubishi CANTER FE SERIES	
F	84-95	FE SERIES	
R	96-04	mitsubishi FUSO FE All Model with O.E.M. Number	
F	96-99	FE All With OEM Number	
F	06	FE SERIES	
R	98-04	FG All Model with O.E.M. Number	
F	00-02	FG All With OEM Number	
R	91	FG FG434 With OEM Number	
R	89-97	FG SERIES	
G63409	C		
R	80-97	FORD PICKUP 1 TON, F-350 / SUPERDUTY RWD Dual Rear Wheels	
R	97	PICKUP, F-450 SUPERDUTY All	
G63410	C		141047
F	80-81	FORD PICKUP 1 TON, F-350 / SUPERDUTY 4WD	
G63411	C		
F	77-86	CHEVROLET PICKUP 1 TON, K30 All	
F	90-91	PICKUP 1 TON, R3500 All	
F	89	PICKUP 1 TON, R3500 Cab & Chassis	
F	89	PICKUP 1 TON, R3500 Crew Cab Pickup	
F	87-88	PICKUP 1 TON, V30 All	
F	89-91	PICKUP 1 TON, V3000 / V3500 All	
F	77-86	GMC PICKUP 1 TON, K35 / K3500 All	
F	87-91	PICKUP 1 TON, V3000 / V3500 All	
G63413	A		
R	78-95	CHEVROLET VAN 1/2 TON, G / EXPRESS All	
R	85-95	VAN 1 TON, G / EXPRESS Extended Cargo Van	
R	85-95	VAN 1 TON, G / EXPRESS Extended Passenger Van	
R	78-95	VAN 1 TON, G / EXPRESS Standard Cargo Van	
R	78-95	VAN 1 TON, G / EXPRESS Standard Passenger Van	
R	78	VAN 1 TON, G / EXPRESS Extended Cargo Van	
R	78-95	VAN 3/4 TON, G / EXPRESS All Exc. 8600# GVW	
R	99-03	DODGE VAN 1/2 TON, A / B SERIES / RAM 109.3 / 277.6 (WheelBase) Exc. 7000# GVW	
R	81-98	VAN 1/2 TON, A / B SERIES / RAM 109.6 / 278.4 (WheelBase) Exc. 7000# GVW	
R	71-80	VAN 1/2 TON, A / B SERIES / RAM All	
R	95-03	VAN 1 TON, A / B SERIES / RAM All	
R	94	VAN 1 TON, A / B SERIES / RAM All Exc. 4000# Front Axle	
R	71-93	VAN 1 TON, A / B SERIES / RAM All	
R	71-03	VAN 3/4 TON, A / B SERIES / RAM All	
R	74-80	VAN, CB300 All	
R	78-95	GMC VAN 1/2 TON, G / SAVANA All	
R	85-96	VAN 1 TON, G / SAVANA Extended Cargo Van	
R	85-96	VAN 1 TON, G / SAVANA Extended Passenger Van	
R	79-96	VAN 1 TON, G / SAVANA Standard Cargo Van	
R	79-96	VAN 1 TON, G / SAVANA Standard Passenger Van	
R	78	VAN 1 TON, G / SAVANA Cutaway Van	
R	78-95	VAN 3/4 TON, G / SAVANA All Exc. 8600# GVW	
R	81-83	PLYMOUTH VAN 1/2 TON, PB SERIES All	
R	74-83	VAN 1 TON, PB SERIES All	
R	74-83	VAN 3/4 TON, PB SERIES All	
G63419	W		
R	98	HINO FA, FB SERIES	

Numerical listing

Shock	POP	Alternative No.	MTG Acc. Supplied
Pos.	Year	Application	
G63432	A	141349,140169	
F		INTERNATIONAL DURASTAR - 1000 SERIES UD UD 1300	
G63455	C		
F	97	FORD F-250 HD 4WD	
F	86-97	PICKUP 1 TON, F-350 / SUPERDUTY 4WD	
G63456	W		
R	86-97	FORD PICKUP 1 TON, F-350 / SUPERDUTY 4WD Exc. Dual Rear Wheels	
G63461	A		
R	97	FORD F-250 HD 4WD	
R	86-97	PICKUP 1 TON, F-350 / SUPERDUTY 4WD Dual Rear Wheels	
R	82-85	PICKUP 1 TON, F-350 / SUPERDUTY 4WD Clevis Type Lower Front Mount; Exc. Dual Rear Wheels or Lift Kit	
R	80-81	PICKUP 1 TON, F-350 / SUPERDUTY 4WD	
R	99-07	PICKUP, F-450 SUPERDUTY All Models with single or dual rear wheels with 165" or 201" wheel base	
R	99-07	PICKUP, F-550 SUPERDUTY All Models with single or dual rear wheels with 165" or 201" wheel base	
G63488	A		
R	92-00	CHEVROLET PICKUP 1 TON, C35/3500 Crew Cab Pickup Exc. HD Straight Front Axle	
R	92-00	PICKUP 1 TON, C35/3500 Standard Cab Pickup Exc. HD Straight Front Axle	
R	88-00	PICKUP 1 TON, C35/3500 Extended Cab Pickup Exc. HD Straight Front Axle	
R	88-90	PICKUP 1 TON, C35/3500 Standard Cab Pickup Exc. HD Straight Front Axle	
R	88-00	PICKUP 1 TON, K35 / K3500 All	
R	88-00	PICKUP 3/4 TON, C25 / C2500 All	
R	88-00	PICKUP 3/4 TON, K25 / K2500 All	
R	92-00	GMC PICKUP 1 TON, C35/3500 Crew Cab Pickup Exc. HD Straight Front Axle	
R	88-00	PICKUP 1 TON, C35/3500 Extended Cab Pickup Exc. HD Straight Front Axle	
R	88-00	PICKUP 1 TON, C35/3500 Standard Cab Pickup Exc. HD Straight Front Axle	
R	88-00	PICKUP 1 TON, K35 / K3500 All	
R	88-00	PICKUP 3/4 TON, C25 / C2500 All	
R	88-00	PICKUP 3/4 TON, K25 / K2500 All	
G63489	A	141277	
F	92-00	CHEVROLET PICKUP 1 TON, C35/3500 Crew Cab Pickup Exc. HD Straight Front Axle	
F	88-00	PICKUP 1 TON, C35/3500 Extended Cab Pickup Exc. HD Straight Front Axle	
F	88-00	PICKUP 1 TON, C35/3500 Standard Cab Pickup Exc. HD Straight Front Axle	
F	88-00	PICKUP 3/4 TON, C25 / C2500 All	
F	92-00	GMC PICKUP 1 TON, C35/3500 Crew Cab Pickup Exc. HD Straight Front Axle	
F	88-00	PICKUP 1 TON, C35/3500 Extended Cab Pickup Exc. HD Straight Front Axle	
F	88-00	PICKUP 1 TON, C35/3500 Standard Cab Pickup Exc. HD Straight Front Axle	
F	88-00	PICKUP 3/4 TON, C25 / C2500 All	
G63492	A	141137	
F	61-67	FORD ECONOLINE All	
G63607	D	140719	
R	00-05	FORD EXCURSION RWD	
G63609	A		
F	88-00	CHEVROLET PICKUP 1 TON, K35 / K3500 All	
F	88-00	PICKUP 3/4 TON, K25 / K2500 All	
F	88-00	GMC PICKUP 1 TON, K35 / K3500 All	

Ultra Truck Shock

Shock	POP	Alternative No.	MTG Acc. Supplied
Pos.	Year	Application	
G63609	A (cont)		
F	88-00	PICKUP 3/4 TON, K25 / K2500 All	
G63610	A	142389	
F	49-52	CHEVROLET FLEETLINE All	
F	49-52	FLEETLINE TRUCK All	
F	89-91	HINO FA14 All Models with O.E.M. Number	
F	92	FA15 All FA, FB Models Trucks with:	
F	93-97	FA1415 All (FA15)	
F	93-97	FA1415 All FA, FB Models Trucks with:	
F	93-97	FA1415 All FA1415 (FA15), FB1715 (FB15)	
F	98-04	FA1517 All FA, FB Models Trucks with:	
F	89-91	FB14 All FA, FB Models Trucks with:	
F	92	FB15 All FA, FB Models Trucks with:	
F	93-97	FB1715 All FA, FB Models Trucks with:	
F	93-97	FB1715 All FA1415 (FA15), FB1715 (FB15)	
F	98-04	FB1817 All FA, FB Models Trucks with:	
F	05-11	MINIBUS FE145 All Models with O.E.M. Number	
F	96-04	FE All Models with O.E.M. Number	
F	88-04	FH All Models with O.E.M. Number	
F	99-10	UD UD 18HD SERIES	
F	11-13	UD 1800 SERIES	
F	95-98	UD 1800 SERIES	
F	95-13	UD 2000 SERIES	
G63614	A	140780	
F	00-05	FORD EXCURSION RWD	
G63622	A	142617	
F	00-02	FORD E-450 ECONOLINE SUPER DUTY All	
F	00-06	ECONOLINE All	
F	20-24	F-600 SUPER DUTY All Applications with OEM Number	
F	99-24	PICKUP 1 TON, F-350 / SUPERDUTY RWD	
F	11-16	PICKUP 1 TON, F-350 / SUPERDUTY All Exc. Off Road Package	
F	99-09	PICKUP 1 TON, F-350 / SUPERDUTY All Exc. Off Road Package	
F	23-24	PICKUP 3/4 TON, F-250 / SUPERDUTY RWD	
F	11-22	PICKUP 3/4 TON, F-250 / SUPERDUTY RWD Exc. Off Road Package	
F	99-10	PICKUP 3/4 TON, F-250 / SUPERDUTY RWD	
F	21-26	VAN 1 TON, ECONOLINE / CLUB WAGON / SUPERDUTY All	
F	99-19	VAN 1 TON, ECONOLINE / CLUB WAGON / SUPERDUTY All	
F	07	VAN 1 TON, ECONOLINE / CLUB WAGON / SUPERDUTY All Exc. Cutaway Chassis	
F	92-05	VAN 1 TON, ECONOLINE / CLUB WAGON / SUPERDUTY All Cutaway Chassis	
F	92-14	VAN 3/4 TON, ECONOLINE / CLUB WAGON / SUPERDUTY All	
G63623	A	142617	
R	00-02	FORD E-450 ECONOLINE SUPER DUTY All	
R	00-06	ECONOLINE All	
R	21-26	VAN 1 TON, ECONOLINE / CLUB WAGON / SUPERDUTY All	
R	99-19	VAN 1 TON, ECONOLINE / CLUB WAGON / SUPERDUTY All	
R	04-11	VAN 1 TON, ECONOLINE / CLUB WAGON / SUPERDUTY All Exc. Cutaway Chassis	
R	92-05	VAN 1 TON, ECONOLINE / CLUB WAGON / SUPERDUTY All Cutaway Chassis	
R	92-14	VAN 3/4 TON, ECONOLINE / CLUB WAGON / SUPERDUTY All	
G63625	C	140702	
F	86-99	CHEVROLET VAN 1 TON, P SERIES All Motorhome Chassis w/ I-Beam Front Suspension	

Numerical listing

Shock	POP	Alternative No.	MTG Acc. Supplied
Pos.	Year	Application	
G63625	C (cont)	140702	
F	86-99	GMC VAN 1 TON, P SERIES All Motorhome Chassis w/ I-Beam Front Suspension	
G63638	A		
R	97-02	CHEVROLET VAN 1 TON, G / EXPRESS All Exc. 8600# GVW	
R	96-02	VAN 3/4 TON, G / EXPRESS All Exc. 8600# GVW	
R	96-02	GMC VAN 1 TON, G / SAVANA All Exc. 8600# GVW	
R	96-02	VAN 3/4 TON, G / SAVANA All Exc. 8600# GVW	
G63661	C	143000	
F	94-02	DODGE PICKUP 1 TON, RAM 3500 (SEE RAM 3500) RWD Exc. Solid Front Axle	
F	94-02	PICKUP 3/4 TON, RAM 2500 (SEE RAM 2500) RWD	
G63662	A		
R	94-02	DODGE PICKUP 1 TON, RAM 3500 (SEE RAM 3500) RWD Exc. Solid Front Axle	
R	94-03	PICKUP 3/4 TON, RAM 2500 (SEE RAM 2500) All Exc. 8800# GVW	
G63671	W		
R	92-96	CHEVROLET VAN 1 TON, G / EXPRESS Cutaway Van	
R	92-96	GMC VAN 1 TON, G / SAVANA Cutaway Van Exc 9200# GVW	
G63673	B	143000	
F	03-10	DODGE PICKUP 1 TON, RAM 3500 (SEE RAM 3500) 4WD	
F	94-02	PICKUP 3/4 TON, RAM 2500 (SEE RAM 2500) 4WD Exc. 8800# GVW	
F	11-24	RAM 3500 (SEE DODGE RAM 3500) 4WD	
G63674	D	142731	
F	94-02	DODGE PICKUP 1 TON, RAM 3500 (SEE RAM 3500) 4WD	
F	94-02	PICKUP 1 TON, RAM 3500 (SEE RAM 3500) RWD Solid Front Axle	
F	94-02	PICKUP 3/4 TON, RAM 2500 (SEE RAM 2500) 4WD 8800# GVW	
G63675	A		
R	77-86	CHEVROLET PICKUP 1 TON, K30 All	
R	90-91	PICKUP 1 TON, R3500 All	
R	89	PICKUP 1 TON, R3500 Cab & Chassis, RWD	
R	89	PICKUP 1 TON, R3500 Crew Cab Pickup, RWD	
R	01-09	PICKUP 1 TON, SILVERADO 3500 All	
R	07-10	PICKUP 1 TON, SILVERADO 3500 HD All	
R	87-88	PICKUP 1 TON, V30 All	
R	89-91	PICKUP 1 TON, V3000 / V3500 All	
R	99-08	PICKUP 3/4 TON, SILVERADO 2500 All	
R	01-10	PICKUP 3/4 TON, SILVERADO 2500 HD All	
R	07	SILVERADO 2500 HD CLASSIC All	
R	94-02	DODGE PICKUP 1 TON, RAM 3500 (SEE RAM 3500) 4WD	
R	94-02	PICKUP 1 TON, RAM 3500 (SEE RAM 3500) RWD Solid Front Axle	
R	94-02	PICKUP 3/4 TON, RAM 2500 (SEE RAM 2500) 4WD 8800# GVW	
R	77-86	GMC PICKUP 1 TON, K35 / K3500 All	
R	87-91	PICKUP 1 TON, V3000 / V3500 All	
R	99-04	SIERRA 2500 All	
R	01-10	SIERRA 2500 HD All	
R	01-06	SIERRA 3500 All	
R	07-10	SIERRA 3500 HD All	
G63692	W		
F	97	FORD PICKUP, F-450 SUPERDUTY All	
G63716	A	142731	
F	75-91	FORD VAN 1/2 TON, ECONOLINE / CLUB WAGON All	
G63783	A	141665	
F	99-04	CHEVROLET PICKUP 3/4 TON, SILVERADO 2500 RWD Exc. Electronic Adjustable Suspension	

Numerical listing

Shock	POP	Alternative No.	MTG Acc. Supplied
Pos.	Year	Application	
G63783	A (cont)		141665
F	99-04	GMC SIERRA 2500 RWD Exc. Electronic Adjustable Suspension	
G63808	D		
R	99-04	FORD PICKUP 1 TON, F-350 / SUPERDUTY RWD	
R	99-04	PICKUP 3/4 TON, F-250 / SUPERDUTY RWD	
G63809	A		
F	00-05	FORD EXCURSION 4WD	
R	97	F-250 HD RWD	
F	99-04	PICKUP 1 TON, F-350 / SUPERDUTY 4WD	
R	80-97	PICKUP 1 TON, F-350 / SUPERDUTY RWD Exc. Dual Rear Wheels	
F	99-04	PICKUP 3/4 TON, F-250 / SUPERDUTY 4WD	
F	99-04	PICKUP, F-450 SUPERDUTY All	
F	99-04	PICKUP, F-550 SUPERDUTY All	
G63810	C		
R	99-04	FORD PICKUP 1 TON, F-350 / SUPERDUTY 4WD	
R	99-04	PICKUP 3/4 TON, F-250 / SUPERDUTY 4WD	
G63817	A		141665
F	01-09	CHEVROLET PICKUP 1 TON, SILVERADO 3500 All	
F	07-10	PICKUP 1 TON, SILVERADO 3500 HD All	
F	05-08	PICKUP 3/4 TON, SILVERADO 2500 All	
F	99-04	PICKUP 3/4 TON, SILVERADO 2500 4WD	
F	05-10	PICKUP 3/4 TON, SILVERADO 2500 HD All 9200# GVW	
F	01-04	PICKUP 3/4 TON, SILVERADO 2500 HD 4WD 9200# GVW	
F	07	SILVERADO 2500 HD CLASSIC All	
F	99-04	GMC SIERRA 2500 4WD	
F	05-10	SIERRA 2500 HD 4WD	
F	01-04	SIERRA 2500 HD All	
F	01-06	SIERRA 3500 All	
F	07-10	SIERRA 3500 HD Torsion Bar (FrontSpringType)	
G63837	D		
R	00-05	FORD EXCURSION 4WD	
G63886	A		142731
F	20-24	FORD F-600 SUPER DUTY All Applications with OEM Number	
F	05-24	PICKUP 1 TON, F-350 / SUPERDUTY 4WD	
F	11-16	PICKUP 1 TON, F-350 / SUPERDUTY All w/ Off Road Package	
F	99-09	PICKUP 1 TON, F-350 / SUPERDUTY All w/ Off Road Package	
F	05-24	PICKUP 3/4 TON, F-250 / SUPERDUTY 4WD	
F	12-16	PICKUP 3/4 TON, F-250 / SUPERDUTY RWD w/ Off Road Package	
G63888	C		
R	13-16	FORD PICKUP 1 TON, F-350 / SUPERDUTY 4WD	
R	05-12	PICKUP 1 TON, F-350 / SUPERDUTY Crew Cab Pickup, 4WD Single Rear Wheels	
R	05-12	PICKUP 1 TON, F-350 / SUPERDUTY Extended Cab Pickup, 4WD Single Rear Wheels	
R	05-12	PICKUP 1 TON, F-350 / SUPERDUTY Standard Cab Pickup, 4WD Single Rear Wheels	
R	05-16	PICKUP 3/4 TON, F-250 / SUPERDUTY 4WD	
G63893	C		143276
F	03-12	CHEVROLET VAN 1 TON, G / EXPRESS All Torsion Bar (FrontSpringType)	
F	06-12	VAN 3/4 TON, G / EXPRESS All Torsion Bar (FrontSpringType)	
F	03-05	VAN 3/4 TON, G / EXPRESS Torsion Bar (FrontSpringType)	
F	10-14	GMC VAN 1/2 TON, G / SAVANA AWD, Torsion Bar (FrontSpringType)	

Ultra Truck Shock

Shock	POP	Alternative No.	MTG Acc. Supplied
Pos.	Year	Application	
G63893	C (cont)		143276
F	03-09	VAN 1/2 TON, G / SAVANA Torsion Bar (FrontSpringType)	
F	03-12	VAN 1 TON, G / SAVANA All Torsion Bar (FrontSpringType)	
F	04-12	VAN 3/4 TON, G / SAVANA All Torsion Bar (FrontSpringType)	
F	03	VAN 3/4 TON, G / SAVANA Torsion Bar (FrontSpringType)	
G63894	B		143078,143276
F	03-14	GMC VAN 1/2 TON, G / SAVANA RWD, Coil (FrontSpringType)	
G63895	A		143276
F	09-22	CHEVROLET EXPRESS 4500 All	
F	17-24	VAN 1 TON, G / EXPRESS All	
F	03-16	VAN 1 TON, G / EXPRESS Coil (FrontSpringType)	
F	17-24	VAN 3/4 TON, G / EXPRESS All	
F	03-16	VAN 3/4 TON, G / EXPRESS Coil (FrontSpringType)	
F	10-20	GMC SAVANA 4500 All	
F	17-24	VAN 1 TON, G / SAVANA All	
F	03-16	VAN 1 TON, G / SAVANA Coil (FrontSpringType)	
F	17-24	VAN 3/4 TON, G / SAVANA All	
F	03-16	VAN 3/4 TON, G / SAVANA Coil (FrontSpringType)	
G63896	B		
R	96-14	GMC VAN 1/2 TON, G / SAVANA All	
G63897	A		
R	09-22	CHEVROLET EXPRESS 4500 All	
R	13-24	VAN 1 TON, G / EXPRESS All	
R	03-12	VAN 1 TON, G / EXPRESS All Single Rear Wheels	
R	03-24	VAN 3/4 TON, G / EXPRESS All	
R	10-20	GMC SAVANA 4500 All	
R	13-24	VAN 1 TON, G / SAVANA All	
R	03-12	VAN 1 TON, G / SAVANA All Single Rear Wheels	
R	03-24	VAN 3/4 TON, G / SAVANA All	
G63918	W		
R	07-09	DODGE SPRINTER 2500 All Single Rear Wheels	
R	03-06	SPRINTER 2500 All Exc. Dual Rear Wheels	
R	07-09	SPRINTER 3500 All Single Rear Wheels	
R	03-06	SPRINTER 3500 All Exc. Dual Rear Wheels	
R	02-06	FREIGHTLINER SPRINTER 2500 All	
R	04-06	MERCEDES-BENZ SPRINTER All Exc. Dual Rear Wheels	
G63969	W		143146
F	05-08	FORD PICKUP, F-450 SUPERDUTY All	
F	05-07	PICKUP, F-550 SUPERDUTY All	
G63971	W		
R	03-10	DODGE PICKUP 1 TON, RAM 3500 (SEE RAM 3500) Crew Cab Pickup, RWD	
R	03-10	PICKUP 3/4 TON, RAM 2500 (SEE RAM 2500) Crew Cab Pickup, RWD	
R	13-25	RAM 3500 (SEE DODGE RAM 3500) Crew Cab Pickup Leaf Spring Suspension	
R	11-12	3500 (SEE DODGE RAM 3500) Crew Cab Pickup, RWD	
G64009	C		142731
F	11-24	RAM 2500 (SEE DODGE RAM 2500) 4WD	
G64010	D		
R	05-16	FORD PICKUP 1 TON, F-350 / SUPERDUTY RWD	
R	11-16	PICKUP 3/4 TON, F-250 / SUPERDUTY RWD Exc. Off Road Package	
R	05-10	PICKUP 3/4 TON, F-250 / SUPERDUTY RWD	
G64011	W		142731
F	04-10	DODGE PICKUP 3/4 TON, RAM 2500 (SEE RAM 2500) 4WD	
G64013	W		
R	03-10	DODGE PICKUP 3/4 TON, RAM 2500 (SEE RAM 2500) 4WD 8800# GVW	

Numerical listing

Shock	POP	Alternative No.	MTG Acc. Supplied
Pos.	Year	Application	
G64013	W (cont)		
R	11-13	RAM 2500 (SEE DODGE RAM 2500) 4WD	
G64042	A		
R	12-15	RAM C/V All Exc. Load Leveling	
G64043	C		
F	03-10	DODGE PICKUP 1 TON, RAM 3500 (SEE RAM 3500) RWD	
F	03-10	PICKUP 3/4 TON, RAM 2500 (SEE RAM 2500) RWD	
F	11-24	RAM 2500 (SEE DODGE RAM 2500) Standard Cab Pickup, RWD	
F	11-20	3500 (SEE DODGE RAM 3500) Standard Cab Pickup, RWD	
G64089	W		
R	07-20	FREIGHTLINER SPRINTER 3500 All	
R	07-10	MERCEDES-BENZ SPRINTER All	
R	11-20	SPRINTER 3500 All	
R	21-24	SPRINTER 3500XD All With OEM Number	
G64121	A		
R	15-18	CHEVROLET PICKUP 1 TON, SILVERADO 3500 All	
R	11-13	PICKUP 1 TON, SILVERADO 3500 All	
R	11-24	PICKUP 1 TON, SILVERADO 3500 HD All	
R	11-18	PICKUP 3/4 TON, SILVERADO 2500 All	
R	11-24	PICKUP 3/4 TON, SILVERADO 2500 HD All	
R	11-24	GMC SIERRA 2500 HD All	
R	11-24	SIERRA 3500 HD All	
R	20-24	RAM 3500 (SEE DODGE RAM 3500) All	
R	13-19	3500 (SEE DODGE RAM 3500) All Coil Spring Suspension	
G64148	A		
F	11-24	CHEVROLET PICKUP 1 TON, SILVERADO 3500 HD All	
F	11-24	PICKUP 3/4 TON, SILVERADO 2500 HD All	
F	11-24	GMC SIERRA 2500 HD All	
F	11-24	SIERRA 3500 HD All	
G64164	W		
R	12-19	NISSAN NV1500 All	
R	12-19	NV2500 All	
R	12-19	NV3500 All	
G64168	N		142731
R	14-24	RAM 2500 (SEE DODGE RAM 2500) All	
G64177	W		
R	15-25	FORD TRANSIT-150 All	
R	15-25	TRANSIT-250 All	
R	15-25	TRANSIT-350 All	
R	25-26	TRANSIT-350 HD All	
G64246	N		
R	14-25	RAM PROMASTER 1500 All With OEM Number	
R	14-25	PROMASTER 2500 All With OEM Number	
R	14-25	PROMASTER 3500 All With OEM Number	
G64268	W		
R	17-24	FORD PICKUP 1 TON, F-350 / SUPERDUTY 4WD	
R	17-23	PICKUP 3/4 TON, F-250 / SUPERDUTY 4WD	
G64269	W		
R	17-24	FORD PICKUP 1 TON, F-350 / SUPERDUTY RWD	
R	17-24	PICKUP 3/4 TON, F-250 / SUPERDUTY RWD	



Medium Duty Shocks

(Alphabetical Listing)

(Numerical Listing)

Amortiguadores de servicio mediano

(Lista alfabética)

(Listado numérico)



Amortisseurs à usage moyen

(Liste alphabétique)

(Ordre numérique)

Gabriel[®]
THE ORIGINAL

APPLICATION GUIDE

Year	Fitment Notes	OEM#								
			Fleetline\ Gas SLX	Classic\ Ultra\ ProGuard\ Guardian	Max Control\ LTV Severe Duty\ Load Carrier\ Hijackers\ OffGrid Nomads	Steering Dampers\ Steering Stabilizer\ Cab Shock	Fleetline\ Gas SLX	Classic\ Ultra\ ProGuard\ Guardian	Max Control\ LTV Severe Duty\ Load Carrier\ Hijackers\ OffGrid Nomads	Steering Dampers\ Steering Stabilizer\ Cab Shock

BERKSHIRE COACH

BERKSHIRE COACH

ULTRA 24

17-24	Coaches with Ford E350 or E450 Chassis	8C2Z-18124-D 8C24-18045-DA ASH-1154		G63622	58622 77614
		8C24-18080-DB ASH-1136 8C2Z-18125-D		G63623	58623 77623

ULTRA 28

17-24	Coaches with Ford E450 Chassis	8C2Z-18124-D 8C24-18045-DA ASH-1154		G63622	58622 77614
		8C24-18080-DB ASH-1136 8C2Z-18125-D		G63623	58623 77623

BLUE BIRD

BLUE BIRD

MICROBIRD TYPE A SCHOOL BUS

92-24	Models with Ford E350 or E450 Chassis	8C2Z-18124-D 8C24-18045-DA ASH-1154 AT-163G		G63622	58622 77614
		8C24-18080-DB ASH-1136 8C2Z-18125-D AT-164G		G63623	58623 77623

CHAMPION BUS INC.

CHAMPION BUS INC.

AMERICAN COACH

	Shuttle buses with Ford E350 or E450 Chassis (Up to 2023) To 2020	8C24-18080-DB ASH-1136 8C2Z-18125-D AT-164G		G63623	58623 77623
	Shuttle buses with Ford E350 or E450 Chassis (Up to 2023) To 2023	8C2Z-18124-D 8C24-18045-DA ASH-1154 AT-163G		G63622	58622 77614

CHALLENGER

	Shuttle buses with Ford E350 or E450 Chassis (Up to 2023)	8C2Z-18124-D 8C24-18045-DA ASH-1154 AT-163G		G63622	58622 77614
		8C24-18080-DB ASH-1136 8C2Z-18125-D AT-164G		G63623	58623 77623

CRUSADER

	Shuttle buses with Ford E350 Chassis To 2020	8C24-18080-DB ASH-1136 8C2Z-18125-D AT-164G		G63623	58623 77623
	Shuttle buses with Ford E350 Chassis To 2023	8C2Z-18124-D 8C24-18045-DA ASH-1154 AT-163G		G63622	58622 77614

LF TRANSPORT

	Shuttle buses with Ford E450 Chassis (Up to 2023)	8C2Z-18124-D 8C24-18045-DA ASH-1154 AT-163G		G63622	58622 77614
		8C24-18080-DB ASH-1136 8C2Z-18125-D AT-164G		G63623	58623 77623

VARIOUS

	GMC P6000 Chassis	22064230		83136
--	-------------------	----------	--	-------	------	------	------	------	------	------

APPLICATION GUIDE

Year	Fitment Notes	OEM#								
			Fleetline/ Gas SLX	Classic/ Ultra/ ProGuard/ Guardian	Max Control/ LTV Severe Duty/ Load Carrier/ HiJackers/ OffGrid Nomads	Steering Dampers/ Steering Stabilizer/ Cab Shock	Fleetline/ Gas SLX	Classic/ Ultra/ ProGuard/ Guardian	Max Control/ LTV Severe Duty/ Load Carrier/ HiJackers/ OffGrid Nomads	Steering Dampers/ Steering Stabilizer/ Cab Shock

CHEVROLET

4, 40, 4000 & 4500 SERIES

CHEVROLET

69-72	All - Exc. Tilt Cab	22012096 3192892	O	83221
67-72	S-40 School Bus	22012096 3192892	O	83221
69-70	D-D Forward Control with 9000 & 11000 lb. Axles - Exc. Tilt Cab	22012096 3192892	O	83221
	D-D Forward Control with Tilt Cab	4940606 22012095	O	83126
67-68	TDM 4 Cycle Detroit Diesel with Tandem Axle - Exc. Tilt Cab	22012096 3192892	O	83221
60-68	C-40 , P-40, SS-40 Models	O	85005
68	Cowl - Exc. School Bus	22012096 3192892	O	83221

5, 50, 5000 & 5500 SERIES

76-89	C Chassis - Conventional Cab	22012196	O	83221
	C, M, S Chassis - Conventional Cab	22012169 22012096	O	83221
75-80	C, M, S Chassis - Conventional Cab	4975510	O	83221
73-80	C, M, S Chassis - Conventional Cab	22007750 4975494 4975467	O	83207
71-72	TDM 4 Cycle Detroit Diesel with Tandem Axle - Exc. Tilt Cab	4940606 22012095	O	83126 89430
69-72	All - Exc. Tilt Cab	22012096 3192892	O	83221
69-70	D-D Forward Control with 9000 & 11000 lb. Axles - Exc. Tilt Cab	22012096 3192892	O	83221
	D-D Forward Control with Tilt Cab	4940606 22012095	O	83126
63-69	C-50, M-50, S-50, SE-50, T-50 Models	O	85005	83221
67-68	TDM 4 Cycle Detroit Diesel with Tandem Axle - Exc. Tilt Cab	22012096 3192892	O	83221
68	Cowl - Exc. School Bus	22012096 3192892	O	83221

4500HD

22-25	Models with 7,000 to 8,000 lb Front Axle;	3989717C1	O	83135
-------	---	-----------	---	-------	------	------	------	------	------	------	------

5500HD

22-25	Models with 7,000 to 8,000 lb Front Axle;	3989717C1	O	83135
-------	---	-----------	---	-------	------	------	------	------	------	------	------

6500HD

22-25	Models with 7,000 to 8,000 lb Front Axle;	3989717C1	O	83135
-------	---	-----------	---	-------	------	------	------	------	------	------	------



C - SERIES (C6500, C7500, C8500) KODIAK

	Models with O.E.M. Number	88982684	I	83136
--	---------------------------	----------	---	-------	------	------	------	------	------	------	------

C60 KODIAK

90-96	Conventional Cab w/ Front Shock with O.E.M. Number	88982682 15588554 15887728 15174898 19152843 22064230 15123676	I	83136
	Conventional Cab w/15000, 19000, 21000 lb Multileaf Springs	15174902 88982686 22064232	I	85071

APPLICATION GUIDE

Year	Fitment Notes	OEM#								
			Fleetline/ Gas SLX	Classic/ Ultra/ ProGuard/ Guardian	Max Control/ LTV Severe Duty/ Load Carrier/ Hijackers/ OffGrid Nomads	Steering Dampers/ Steering Stabilizer/ Cab Shock	Fleetline/ Gas SLX	Classic/ Ultra/ ProGuard/ Guardian	Max Control/ LTV Severe Duty/ Load Carrier/ Hijackers/ OffGrid Nomads	Steering Dampers/ Steering Stabilizer/ Cab Shock

CHEVROLET

CHEVROLET

C60 KODIAK (cont)

90-96	Conventional Cab w/19000, 21000, 23000 lb Taperleaf Springs (EXC Low Profile Vehicle)	22064233							83136			
	Truck Cabs with Link Cabmate Model GMC104TK	1201-0054 1202-0054	00				83021					



C4500 KODIAK

03-09	C Chassis - Conventional Cab	88982682 15588554 15887728 19152843 22064230 15123676		83136								
	C Chassis - Conventional Cab w/19000, 21000, 23000 lb Taperleaf Springs (EXC Low Profile Vehicle)	22064233							83136			
	C Chassis - Conventional Cab With 15000, 19000, 21000 lb Multileaf Springs	15174902 88982686 22064232							85071			
	Truck Cabs with Link Cabmate Model GMC104TK	1201-0054 1202-0054	00				83021					
90-02	C Chassis - Conventional Cab	88982682 15588554 15887728 19152843 22064230 15123676		83136								
	C Chassis - Conventional Cab w/19000, 21000, 23000 lb Taperleaf Springs (EXC Low Profile Vehicle)	22064233							83136			
	C Chassis - Conventional Cab With 15000, 19000, 21000 lb Multileaf Springs	15174902 88982686 22064232							85071			
83-99	C Chassis - Conventional Cab with 9100 to 17500 lb Rear Axle	22064432							83221			

C5500 KODIAK

03-09	C Chassis - Conventional Cab	88982682 15588554 15887728 19152843 22064230 15123676		83136								
	C Chassis - Conventional Cab w/19000, 21000, 23000 lb Taperleaf Springs (EXC Low Profile Vehicle)	22064233							83136			
	C Chassis - Conventional Cab With 15000, 19000, 21000 lb Multileaf Springs	15174902 88982686 22064232							85071			
	Truck Cabs with Link Cabmate Model GMC104TK	1201-0054 1202-0054	00				83021					
92-02	C Chassis - Conventional Cab	88982682 15588554 15887728 19152843 22064230 15123676		83136								
	C Chassis - Conventional Cab w/19000, 21000, 23000 lb Taperleaf Springs (EXC Low Profile Vehicle)	22064233							83136			
	C Chassis - Conventional Cab With 15000, 19000, 21000 lb Multileaf Springs	15174902 88982686 22064232							85071			
92-99	C Chassis - Conventional Cab with 9100 to 17500 lb Rear Axle	22064432							83221			

APPLICATION GUIDE

Year	Fitment Notes	OEM#								
			Fleetline/ Gas SLX	Classic/ Ultra/ ProGuard/ Guardian	Max Control/ LTV Severe Duty/ Load Carrier/ HiJackers/ OffGrid Nomads	Steering Dampers/ Steering Stabilizer/ Cab Shock	Fleetline/ Gas SLX	Classic/ Ultra/ ProGuard/ Guardian	Max Control/ LTV Severe Duty/ Load Carrier/ HiJackers/ OffGrid Nomads	Steering Dampers/ Steering Stabilizer/ Cab Shock

CHEVROLET

CHEVROLET

C5500 KODIAK (cont)

90-91	C Chassis - Conventional Cab	88982682 15588554 15887728 19152843 22064230 15123676	I	83136
	C Chassis - Conventional Cab w/19000, 21000, 23000 lb Taperleaf Springs (EXC Low Profile Vehicle)	22064233	I	83136
	C Chassis - Conventional Cab With 15000, 19000, 21000 lb Multileaf Springs	15174902 88982686 22064232	I	85071
	C Chassis - Conventional Cab with 9100 to 17500 lb Rear Axle	22064432	O	83221
	Truck Cabs with Link Cabmate Model GMC104TK	1201-0054 1202-0054	O	83021
83-89	C Chassis - Conventional Cab with 9100 to 17500 lb Rear Axle	22064432	O	83221



C6500 KODIAK

97-09	Conventional Cab w/ Front Shock with O.E.M. Number	88982682 15588554 15887728 15174898 19152843 22064230 15123676	I	83136
	Conventional Cab w/15000, 19000, 21000 lb Multileaf Springs	15174902 88982686 22064232	I	85071
	Conventional Cab w/19000, 21000, 23000 lb Taperleaf Springs (EXC Low Profile Vehicle)	22064233	I	83136
	Models with Hendrickson Air Suspension (Stamping number 47902-13)	12474915 15963161	O	83122 89406
	Models with Hendrickson Air Suspension with O.E.M. Number	60670-005 060665-003 12474917 15740554 59057-001 47902-29	O	83137
	Truck Cabs with Link Cabmate Model GMC104TK	1201-0054 1202-0054	O	83021
97-99	Conventional Cab with 9100 to 17500 lb Rear Axle	22064432	O	83221

C7500 KODIAK

00-01	Conventional Cab w/ Front Shock with O.E.M. Number	88982682 15588554 15887728 15174898 19152843 22064230 15123676	I	83136
	Conventional Cab w/15000, 19000, 21000 lb Multileaf Springs	15174902 88982686 22064232	I	85071
	Conventional Cab w/19000, 21000, 23000 lb Taperleaf Springs (EXC Low Profile Vehicle)	22064233	I	83136
	Models with Hendrickson Air Suspension (Stamping number 47902-13)	12474915 15963161	O	83122 89406
	Models with Hendrickson Air Suspension with O.E.M. Number	60670-005 060665-003 12474917 15740554 59057-001 47902-29	O	83137
	Truck Cabs with Link Cabmate Model GMC104TK	1201-0054 1202-0054	O	83021

APPLICATION GUIDE

Year	Fitment Notes	OEM#								
			Fleetline\ Gas SLX	Classic\ Ultra\ ProGuard\ Guardian	Max Control\ LTV Severe Duty\ Load Carrier\ Hijackers\ OffGrid Nomads	Steering Dampers\ Steering Stabilizer\ Cab Shock	Fleetline\ Gas SLX	Classic\ Ultra\ ProGuard\ Guardian	Max Control\ LTV Severe Duty\ Load Carrier\ Hijackers\ OffGrid Nomads	Steering Dampers\ Steering Stabilizer\ Cab Shock

CHEVROLET EXPRESS 4500

CHEVROLET

09-22	All			61685 G63895	NM1016	61687 G63897	58638 77638 NM1015
-------	-----	--	--	-------	--------------	--------	-------	--	-------	--------------	--------------------	-------

LCF 3500

24-25	All	98381010 98232671		83515
		98380746			83159
16-23	All	98381010 98232671		83515
		98380746			83159

LCF 3500HD

18	All	98381010 98232671		83515
		98380746			83159
16-17	All	98381010 98232671		83515
		98380746			83159

LCF 4500

17-25	All	983439850 98380746			83159
		With OEM Number		98381010 98232671 893810110		83515

LCF 4500HD

17-25	All	983439850 98380746			83159
		With OEM Number		98381010 98232671 893810110		83515

LCF 4500XD

17-25	With OEM Number	98381010 893810110		83515
-------	-----------------	--------------------	--	-------	-------	-------	-------	--	-------	-------	-------	-------

LCF 5500XD

25	All	98380746			83159
		With OEM Number		98232671		83515
		With OEM Number 983439850		983439850		83159
17-24	All	983439850 98380746			83159
		With OEM Number		98381010 98232671 893810110		83515
		With OEM Number 983439850		983439850		83159

P60

92-96	Motorhome Chassis	22064233			83136
-------	-------------------	----------	--	-------	-------	-------	-------	--	-------	-------	-------	-------

P6000

92-96	Motorhome Chassis	22064233			83136
-------	-------------------	----------	--	-------	-------	-------	-------	--	-------	-------	-------	-------

SILVERADO 4500 HD

23-24	Models with 11K, 13.5K or 15.5K VARI-RATE Rear Suspension	4208946C1			83398
		Models with Taperleaf Front		4089293C1		83397
22-24	Models with 4X4 Rear	4109458C2			83243

APPLICATION GUIDE

Year	Fitment Notes	OEM#								
			Fleetline/ Gas SLX	Classic/ Ultra/ ProGuard/ Guardian	Max Control/ LTV Severe Duty/ Load Carrier/ HiJackers/ OffGrid Nomads	Steering Dampers/ Steering Stabilizer/ Cab Shock	Fleetline/ Gas SLX	Classic/ Ultra/ ProGuard/ Guardian	Max Control/ LTV Severe Duty/ Load Carrier/ HiJackers/ OffGrid Nomads	Steering Dampers/ Steering Stabilizer/ Cab Shock

CHEVROLET

CHEVROLET

SILVERADO 4500 HD (cont)

19-24	Models with IROS Rear	4214011C2		OO	85670
19-22	Diesel Low Cab Forward models with 14,000 to 15,000 lb Rear	8983807460 8-98380-746-0		OO	83159
	Diesel Low Cab Forward models with 14,500 lb GVWR	8983810100	 OO	83515
	Diesel Low Cab Forward models with 15,000 to 16,000 lb Rear	8983807470		OO	83159
	Diesel Low Cab Forward models with 16,000 lb to 19,500 lb GVWR	8983810120	 OO	83515
	Models with 11K, 13.5K or 15.5K VARI-RATE Rear Suspension	4208946C1 4206863C1		OO	83398
	Models with 7,000 to 8,000 lb Front Axle	3989717C1	OO	83135
	Models with Taperleaf Front	4109582C1 4089293C1 4109583C1 4207304C1	OO	83397
19-21	Models with 4 x 4 Rear	4109458C2		OO	83243

SILVERADO 4500HD

25	Models with 11K, 13.5K, 15.5K Vari-Rate	4208946C1		OO	83398
	Models with 4X4 Rear	4109458C2		OO	83243
	Models with IROS Rear	4214011C2		OO	85670
	Models with Taperleaf Front	4089293C1	OO	83397

SILVERADO 5500 HD

23-24	Models with 4X4 Rear	4109458C2		OO	83243
19-24	Models with IROS Rear	4214011C2		OO	85670
24	Models with 11K, 13.5K or 15.5K VARI-RATE Rear Suspension	4208946C1		OO	83398
	Models with Taperleaf Front	4089293C1	OO	83397
19-23	Models with 11K, 13.5K or 15.5K VARI-RATE Rear Suspension	4208946C1 4206863C1		OO	83398
	Models with Taperleaf Front	4109582C1 4089293C1 4109583C1 4207304C1	OO	83397
19-22	Diesel Low Cab Forward models with 14,000 to 15,000 lb Rear	8983807460 8-98380-746-0		OO	83159
	Diesel Low Cab Forward models with 14,500 lb GVWR	8983810100	 OO	83515
	Diesel Low Cab Forward models with 15,000 to 16,000 lb Rear	8983807470		OO	83159
	Diesel Low Cab Forward models with 16,000 lb to 19,500 lb GVWR	8983810120	 OO	83515
	Models with 4 x 4 Rear	4109458C2		OO	83243
	Models with 7,000 to 8,000 lb Front Axle	3989717C1	OO	83135

SILVERADO 5500HD

25	Models with 11K, 13.5K, 15.5K Vari-Rate	4208946C1		OO	83398
	Models with 4X4 Rear	4109458C2		OO	83243
	Models with IROS Rear	4214011C2		OO	85670
	Models with Taperleaf Front	4089293C1	OO	83397

APPLICATION GUIDE

Year	Fitment Notes	OEM#								
			Fleetline\ Gas SLX	Classic\ Ultra\ ProGuard\ Guardian	Max Control\ LTV Severe Duty\ Load Carrier\ Hijackers\ OffGrid Nomads	Steering Dampers\ Steering Stabilizer\ Cab Shock	Fleetline\ Gas SLX	Classic\ Ultra\ ProGuard\ Guardian	Max Control\ LTV Severe Duty\ Load Carrier\ Hijackers\ OffGrid Nomads	Steering Dampers\ Steering Stabilizer\ Cab Shock

CHEVROLET

CHEVROLET

SILVERADO 6500 HD

23-24	Models with 4X4 Rear	4109458C2	83243
19-24	Models with IROS Rear	4214011C2	85670
24	Models with 11K, 13.5K or 15.5K VARI-RATE Rear Suspension	4208946C1	83398
	Models with Taperleaf Front	4089293C1	OO	83397
19-23	Models with 11K, 13.5K or 15.5K VARI-RATE Rear Suspension	4208946C1 4206863C1	83398
	Models with Taperleaf Front	4109582C1 4089293C1 4109583C1 4207304C1	OO	83397
19-22	Models with 4 x 4 Rear	4109458C2	83243
	Models with 7,000 to 8,000 lb Front Axle	3989717C1	OO	83135

SILVERADO 6500HD

25	Models with 11K, 13.5K, 15.5K Vari-Rate	4208946C1	83398
	Models with 4X4 Rear	4109458C2	83243
	Models with IROS Rear	4214011C2	85670
	Models with Taperleaf Front	4089293C1	OO	83397



T5500

97-09	FL1 Tilt Cab with 8100 lb Axle	22165188 22165187 22064804 22064805		83136
	FL2 Tilt Cab with 5000 to 11000 lb Axle	22166442 22064807		83136
	FL3 Tilt Cab with 14575 lb Axle	22165189 22064806		83136
90-06	Tilt Cab w/15000, 19000, 21000 lb Multileaf Springs	15174902 22064232		85071
92-99	Tilt Cab w/19000, 21000, 23000 lb Taperleaf Springs (EXC Low Profile Veh.)	22064233		83136

T6500

06-09	15,000lb; 17,000lb; 19,000lb; 21,000lb and 23,000lb Axle	88982687		85705
04-09	FL1 Tilt Cab with 8100 lb Axle	22165188 22165187 22064804 22064805		83136
	FL2 Tilt Cab with 5000 to 11000 lb Axle	22166442 22064807		83136
	FL3 Tilt Cab with 14575 lb Axle	22165189 22064806		83136
04-05	Tilt Cab w/15000, 19000, 21000 lb Multileaf Springs	15174902 22064232		85071
03	FL1 Tilt Cab with 8100 lb Axle	22165188 22165187 22064804 22064805		83136
	FL2 Tilt Cab with 5000 to 11000 lb Axle	22166442 22064807		83136
	FL3 Tilt Cab with 14575 lb Axle	22165189 22064806		83136
	Tilt Cab w/15000, 19000, 21000 lb Multileaf Springs	15174902 22064232		85071
00-02	Low profile, with Axle Code FL1	22165187	OO	83163
	Tilt Cab with 23,000 lb Axles; Tapered Leaf Spring	22064233		83136

APPLICATION GUIDE

Year	Fitment Notes	OEM#								
			Fleetline/ Gas SLX	Classic/ Ultra/ ProGuard/ Guardian	Max Control/ LTV Severe Duty/ Load Carrier/ HiJackers/ OffGrid Nomads	Steering Dampers/ Steering Stabilizer/ Cab Shock	Fleetline/ Gas SLX	Classic/ Ultra/ ProGuard/ Guardian	Max Control/ LTV Severe Duty/ Load Carrier/ HiJackers/ OffGrid Nomads	Steering Dampers/ Steering Stabilizer/ Cab Shock

CHEVROLET

CHEVROLET

T6500 (cont)

00-02	with 16,900lb Axle. Tapered Leaf Springs	22064489	I O	85332
	With Hendrickson Air Suspension	15963161 12474917	O O	85013
97-02	FL1 Tilt Cab with 8100 lb Axle	22165188 22165187 22064804 22064805	I T	83136
	FL2 Tilt Cab with 5000 to 11000 lb Axle	22166442 22064807	I T	83136
	FL3 Tilt Cab with 14575 lb Axle	22165189 22064806	I T	83136
	Tilt Cab w/15000, 19000, 21000 lb Multileaf Springs	15174902 22064232	I T	I T	85071
97-99	Tilt Cab w/19000, 21000, 23000 lb Taperleaf Springs (EXC Low Profile Veh.)	22064233	I T	83136
99	Models with Hendrickson Air Suspension (Stamping number 47902-13)	12474915 15963161	O O	83122 89406
92-96	Tilt Cab w/19000, 21000, 23000 lb Taperleaf Springs (EXC Low Profile Veh.)	22064233	I T	83136
90-96	Tilt Cab w/15000, 19000, 21000 lb Multileaf Springs	15174902 22064232	I T	85071



T7500

06-09	15,000lb;17,000lb; 19,000lb; 21,000lb and 23,000lb Axle	88982687	I T	85705
04-09	FL1 Tilt Cab with 8100 lb Axle	22165188 22165187 22064804 22064805	I T	83136
	FL2 Tilt Cab with 5000 to 11000 lb Axle	22166442 22064807	I T	83136
	FL3 Tilt Cab with 14575 lb Axle	22165189 22064806	I T	83136
04-05	Tilt Cab w/15000, 19000, 21000 lb Multileaf Springs	15174902 22064232	I T	85071
00-02	Low profile, with Axle Code FL1	22165187	O O	83163
	Tilt Cab with 23,000 lb Axles; Tapered Leaf Spring	22064233	I T	83136
	with 16,900lb Axle. Tapered Leaf Springs	22064489	I O	85332
	With Hendrickson Air Suspension	15963161 12474917	O O	85013
97-02	FL1 Tilt Cab with 8100 lb Axle	22165188 22165187 22064804 22064805	I T	83136
	FL2 Tilt Cab with 5000 to 11000 lb Axle	22166442 22064807	I T	83136
	FL3 Tilt Cab with 14575 lb Axle	22165189 22064806	I T	83136
	Tilt Cab w/15000, 19000, 21000 lb Multileaf Springs	15174902 22064232	I T	85071
97-99	Tilt Cab w/19000, 21000, 23000 lb Taperleaf Springs (EXC Low Profile Veh.)	22064233	I T	83136
99	Models with Hendrickson Air Suspension (Stamping number 47902-13)	12474915 15963161	O O	83122 89406

T8500

06-09	15,000lb;17,000lb; 19,000lb; 21,000lb and 23,000lb Axle	88982687	I T	85705
-------	---	----------	------	------	------	------	--------	-------	------	------	------

APPLICATION GUIDE

Year	Fitment Notes	OEM#								
			Fleetline\ Gas SLX	Classic\ Ultra\ ProGuard\ Guardian	Max Control\ LTV Severe Duty\ Load Carrier\ Hijackers\ OffGrid Nomads	Steering Dampers\ Steering Stabilizer\ Cab Shock	Fleetline\ Gas SLX	Classic\ Ultra\ ProGuard\ Guardian	Max Control\ LTV Severe Duty\ Load Carrier\ Hijackers\ OffGrid Nomads	Steering Dampers\ Steering Stabilizer\ Cab Shock

CHEVROLET

CHEVROLET

T8500 (cont)

04-09	FL1 Tilt Cab with 8100 lb Axle	22165188 22165187 22064804 22064805	I	83136
	FL2 Tilt Cab with 5000 to 11000 lb Axle	22166442 22064807	I	83136
	FL3 Tilt Cab with 14575 lb Axle	22165189 22064806	I	83136
	Models with Hendrickson Air Suspension (Stamping number 47902-13)	12474915 15963161	O	83122 89406
04-05	Tilt Cab w/15000, 19000, 21000 lb Multileaf Springs	15174902 22064232	I	85071

VAN 1 TON, P SERIES

92-96	Motorhome Chassis	22064233	I	83136
-------	-------------------	----------	---	------	------	------	------	-------	------	------	------

W4500 TILTMASTER

87-10	Models with 11000 lb & 13000 lb Suspension	9516306471 97083029 94454987 98232671 97083027 8972536200 8-94454-986-0 8-94454-987-0 97253620 8-97253-620-0 8944549870 8944549860	O	83515
-------	--	---	---	-------	------	------	------	------	------	------	------

W5500 TILTMASTER

88-10	Models with 11000 lb & 13000 lb Suspension	97253620	O	83515
-------	--	----------	---	-------	------	------	------	------	------	------	------

W6500 TILTMASTER

87-96	Models with 11000 lb & 13000 lb Suspension	1-51630-168-1	O	83515
-------	--	---------------	---	-------	------	------	------	------	------	------	------

CHRYSLER

CHRYSLER

MOTORHOME CHASSIS

73-81	M & R-300, 400, 500 Motorhome Chassis	3638112	O	G63183
63-72	M-300, M-375 & R-375 Motorhome Chassis	2961043 3633744	O	G63183

COACH HOUSE

COACH HOUSE

PLATINUM

03-24	Motorhomes with Ford E450 Chassis	8C2Z-18124-D 8C24-18045-DA ASH-1154 AT-163G	O	G63622	58622 77614
		8C24-18080-DB ASH-1136 8C2Z-18125-D AT-164G	O	G63623	58623 77623



PLATINUM III

19-22	MotorHomes with Ford Transit-350 Chassis		I	G57816 ⁴⁰	G64177
-------	--	--	---	------	----------------------	------	------	------	--------	------	------

PLATINUM IV

23-24	Motorhomes with Ford E450 Chassis	8C2Z-18124-D 8C24-18045-DA ASH-1154 AT-163G	O	G63622	58622 77614
-------	-----------------------------------	--	---	------	--------	----------------	------	------	------	------	------

APPLICATION GUIDE

Year	Fitment Notes	OEM#								
			Fleetline\ Gas SLX	Classic\ Ultra\ ProGuard\ Guardian	Max Control\ LTV Severe Duty\ Load Carrier\ HiJackers\ OffGrid Nomads	Steering Dampers\ Steering Stabilizer\ Cab Shock	Fleetline\ Gas SLX	Classic\ Ultra\ ProGuard\ Guardian	Max Control\ LTV Severe Duty\ Load Carrier\ HiJackers\ OffGrid Nomads	Steering Dampers\ Steering Stabilizer\ Cab Shock

COACH HOUSE

COACH HOUSE

PLATINUM IV (cont)

23-24	Motorhomes with Ford E450 Chassis	8C24-18080-DB ASH-1136 8C2Z-18125-D AT-164G	 O	G63623	58623 77623
-------	-----------------------------------	--	------	------	------	------	-------	------	--------	----------------	------



COACHMEN

COACHMEN

AURORA

09	MotorHomes with Ford F53 Chassis with 16,000 lb GVW to 22,000 lb GVW	ASH-1229 ASH-1228 9U94-18045-AA ASH-1205 AT-620 ASH-1022 1C34-18045-AA ASH-294 9U9Z-18124-A ASH-25822 ASH-25823 1C34-18045-JA AT-766	OO	83209	 O
		ASH-1206 9U94-18080-AA AT-621 ASH-25824 9U9Z-18125-A ASH-1023 ASH-1230 ASH-137	OO	83122 89406
08	MotorHomes with Ford F53 Chassis with 16,000 lb GVW to 22,000 lb GVW	ASH-1229 ASH-1228 9U94-18045-AA ASH-1205 AT-620 ASH-1022 1C34-18045-AA ASH-294 9U9Z-18124-A ASH-25822 ASH-25823 1C34-18045-JA AT-766	OO	83209	 O
		ASH-1206 9U94-18080-AA AT-621 ASH-25824 9U9Z-18125-A ASH-1023 ASH-1230 ASH-137	OO	83122 89406
07	MotorHomes with Ford F53 Chassis with 16,000 lb GVW to 22,000 lb GVW	ASH-1229 ASH-1228 9U94-18045-AA ASH-1205 AT-620 ASH-1022 1C34-18045-AA ASH-294 9U9Z-18124-A ASH-25822 ASH-25823 1C34-18045-JA AT-766	OO	83209	 O
		ASH-1206 9U94-18080-AA AT-621 ASH-25824 9U9Z-18125-A ASH-1023 ASH-1230 ASH-137	OO	83122 89406

APPLICATION GUIDE

Year	Fitment Notes	OEM#								
			Fleetline/ Gas SLX	Classic/ Ultra/ ProGuard/ Guardian	Max Control/ LTV Severe Duty/ Load Carrier/ Hijackers/ OffGrid Nomads	Steering Dampers/ Steering Stabilizer/ Cab Shock	Fleetline/ Gas SLX	Classic/ Ultra/ ProGuard/ Guardian	Max Control/ LTV Severe Duty/ Load Carrier/ Hijackers/ OffGrid Nomads	Steering Dampers/ Steering Stabilizer/ Cab Shock

COACHMEN

COACHMEN

AURORA (cont)

04-06	MotorHomes with Ford F53 Chassis with 16,000 lb GVW to 22,000 lb GVW	ASH-1229 ASH-1228 9U94-18045-AA ASH-1205 AT-620 ASH-1022 1C34-18045-AA ASH-294 9U9Z-18124-A ASH-25822 ASH-25823 1C34-18045-JA AT-766	 o	83209						
		ASH-1206 9U94-18080-AA AT-621 ASH-25824 9U9Z-18125-A ASH-1023 ASH-1230 ASH-137	 o	 o	83122 89406

BEYOND

26	All	FK3Z-18125-C				G64177	
19-22	MotorHomes with Ford Transit-350 Chassis		 o	G57816 ⁴⁰	 o	G64177

CATALINA

	MotorHomes with Ford E350 or E450 Chassis	8C2Z-18124-D 8C24-18045-DA ASH-1154 AT-163G	 o	G63622	58622 77614
		8C24-18080-DB ASH-1136 8C2Z-18125-D AT-164G	 o	 o	G63623	58623 77623



CLASS A MOTORHOMES

	MotorHomes with Freightliner XC Chassis	66153-002 F4-BE5-C832-MO	 o	83124
--	---	-----------------------------	-------	-------	------	------	------	--	--	------	------	------	------

CONCORD

23-24	MotorHomes with Ford E350 or E450 Chassis	8C2Z-18124-D 8C24-18045-DA ASH-1154 AT-163G	 o	G63622	58622 77614
		8C24-18080-DB ASH-1136 8C2Z-18125-D AT-164G	 o	 o	G63623	58623 77623
20-22	MotorHomes with Ford E350 or E450 Chassis	8C2Z-18124-D 8C24-18045-DA ASH-1154 AT-163G	 o	G63622	58622 77614	 o
		8C24-18080-DB ASH-1136 8C2Z-18125-D AT-164G	 o	 o	G63623	58623 77623
07-19	MotorHomes with Ford E350 or E450 Chassis	8C2Z-18124-D 8C24-18045-DA ASH-1154 AT-163G	 o	G63622	58622 77614	 o
		8C24-18080-DB ASH-1136 8C2Z-18125-D AT-164G	 o	 o	G63623	58623 77623
04-06	MotorHomes with Ford E350 or E450 Chassis	8C2Z-18124-D 8C24-18045-DA ASH-1154 AT-163G	 o	G63622	58622 77614	 o

APPLICATION GUIDE

Year	Fitment Notes	OEM#								
			Fleetline\ Gas SLX	Classic\ Ultra\ ProGuard\ Guardian	Max Control\ LTV Severe Duty\ Load Carrier\ HIJackers\ OffGrid Nomads	Steering Dampers\ Steering Stabilizer\ Cab Shock	Fleetline\ Gas SLX	Classic\ Ultra\ ProGuard\ Guardian	Max Control\ LTV Severe Duty\ Load Carrier\ HIJackers\ OffGrid Nomads	Steering Dampers\ Steering Stabilizer\ Cab Shock

COACHMEN

COACHMEN

CONCORD (cont)

04-06	MotorHomes with Ford E350 or E450 Chassis	8C24-18080-DB ASH-1136 8C2Z-18125-D AT-164G											
-------	---	--	--	--	--	--	--	--	--	--	--	--	--

CROSS COUNTRY

06	MotorHomes with Freightliner XC Chassis ADL200 Suspension w/ 20K Rear	16-16873-000											
	MotorHomes with Freightliner XC Chassis AS120 Front Suspension	16-16874-000 16-16737-000 141700131810	OO	83160									
	MotorHomes with Freightliner XC Chassis Rear Shock with O.E.M. Number	141700131809 16-16736-000											
	MotorHomes with Freightliner XC Chassis ZF - IFS Front Suspension with 23,000 lb GVW or Greater	16-18103-000 481700000493	IT	85900									

CROSS COUNTRY ELITE

03-05	MotorHomes with Freightliner XC Chassis ADL200 Suspension w/ 20K Rear	16-16873-000											
	MotorHomes with Freightliner XC Chassis AS120 Front Suspension	16-16874-000 16-16737-000 141700131810	OO	83160									
	MotorHomes with Freightliner XC Chassis Rear Shock with O.E.M. Number	141700131809 16-16736-000											
	MotorHomes with Freightliner XC Chassis ZF - IFS Front Suspension with 23,000 lb GVW or Greater	16-18103-000 481700000493	IT	85900									

CROSS COUNTRY SE

03-05	MotorHomes with Freightliner XC Chassis ADL200 Suspension w/ 20K Rear	16-16873-000											
	MotorHomes with Freightliner XC Chassis AS120 Front Suspension	16-16874-000 16-16737-000 141700131810	OO	83160									
	MotorHomes with Freightliner XC Chassis Rear Shock with O.E.M. Number	141700131809 16-16736-000											
	MotorHomes with Freightliner XC Chassis ZF - IFS Front Suspension with 23,000 lb GVW or Greater	16-18103-000 481700000493	IT	85900									



CROSS TRAIL TRANSIT

21-22	MotorHomes with Ford Transit-350 Chassis												
-------	--	--	--	--	--	--	--	--	--	--	--	--	--

ENCORE

21-24	MotorHomes with Ford F53 Chassis with 16,000 lb GVW to 22,000 lb GVW	ASH-1229 ASH-1228 9U94-18045-AA ASH-1205 AT-620 ASH-1022 1C34-18045-AA ASH-294 9U9Z-18124-A ASH-25822 ASH-25823 1C34-18045-JA AT-766											
-------	--	--	--	--	--	--	--	--	--	--	--	--	--

APPLICATION GUIDE

Year	Fitment Notes	OEM#								
			Fleetline\ Gas SLX	Classic\ Ultra\ ProGuard\ Guardian	Max Control\ LTV Severe Duty\ Load Carrier\ Hijackers\ OffGrid Nomads	Steering Dampers\ Steering Stabilizer\ Cab Shock	Fleetline\ Gas SLX	Classic\ Ultra\ ProGuard\ Guardian	Max Control\ LTV Severe Duty\ Load Carrier\ Hijackers\ OffGrid Nomads	Steering Dampers\ Steering Stabilizer\ Cab Shock

COACHMEN

COACHMEN

ENCORE (cont)

21-24	MotorHomes with Ford F53 Chassis with 16,000 lb GVW to 22,000 lb GVW	ASH-1206 9U94-18080-AA AT-621 ASH-25824 9U9Z-18125-A ASH-1023 ASH-1230 ASH-137	83122 89406
-------	--	---	-----	-----	-----	-----	-----	----------------	-----	-----	-----

ENCOUNTER

11-16	MotorHomes with Ford F53 Chassis with 16,000 lb GVW to 22,000 lb GVW	ASH-1229 ASH-1228 9U94-18045-AA ASH-1205 AT-620 ASH-1022 1C34-18045-AA ASH-294 9U9Z-18124-A ASH-25822 ASH-25823 1C34-18045-JA AT-766	83209
		ASH-1206 9U94-18080-AA AT-621 ASH-25824 9U9Z-18125-A ASH-1023 ASH-1230 ASH-137	83122 89406

FREEDOM EXPRESS

09	MotorHomes with Ford E350 or E450 Chassis	8C2Z-18124-D 8C24-18045-DA ASH-1154 AT-163G	...	G63622	58622 77614
		8C24-18080-DB ASH-1136 8C2Z-18125-D AT-164G	G63623	58623 77623	...
04-08	MotorHomes with Ford E350 or E450 Chassis	8C2Z-18124-D 8C24-18045-DA ASH-1154 AT-163G	...	G63622	58622 77614
		8C24-18080-DB ASH-1136 8C2Z-18125-D AT-164G	G63623	58623 77623	...



FREELANDER

08-24	MotorHomes with Ford E350 or E450 Chassis	8C2Z-18124-D 8C24-18045-DA ASH-1154 AT-163G	...	G63622	58622 77614
		8C24-18080-DB ASH-1136 8C2Z-18125-D AT-164G	G63623	58623 77623	...
03-07	MotorHomes with Ford E350 or E450 Chassis	8C2Z-18124-D 8C24-18045-DA ASH-1154 AT-163G	...	G63622	58622 77614
		8C24-18080-DB ASH-1136 8C2Z-18125-D AT-164G	G63623	58623 77623	...

LEPRECHAUN

11-24	MotorHomes with Ford E350 or E450 Chassis	8C2Z-18124-D 8C24-18045-DA ASH-1154 AT-163G	...	G63622	58622 77614
		8C24-18080-DB ASH-1136 8C2Z-18125-D AT-164G	G63623	58623 77623	...

APPLICATION GUIDE

Year	Fitment Notes	OEM#								
			Fleetline\ Gas SLX	Classic\ Ultra\ ProGuard\ Guardian	Max Control\ LTV Severe Duty\ Load Carrier\ HiJackers\ OffGrid Nomads	Steering Dampers\ Steering Stabilizer\ Cab Shock	Fleetline\ Gas SLX	Classic\ Ultra\ ProGuard\ Guardian	Max Control\ LTV Severe Duty\ Load Carrier\ HiJackers\ OffGrid Nomads	Steering Dampers\ Steering Stabilizer\ Cab Shock

COACHMEN

COACHMEN

LEPRECHAUN (cont)

10	MotorHomes with Ford E350 or E450 Chassis	8C2Z-18124-D 8C24-18045-DA ASH-1154 AT-163G	 O	G63622	58622 77614
		8C24-18080-DB ASH-1136 8C2Z-18125-D AT-164G	 O	G63623	58623 77623
08-09	MotorHomes with Ford E350 or E450 Chassis	8C2Z-18124-D 8C24-18045-DA ASH-1154 AT-163G	 O	G63622	58622 77614
		8C24-18080-DB ASH-1136 8C2Z-18125-D AT-164G	 O	G63623	58623 77623
03-07	MotorHomes with Ford E350 or E450 Chassis	8C2Z-18124-D 8C24-18045-DA ASH-1154 AT-163G	 O	G63622	58622 77614
		8C24-18080-DB ASH-1136 8C2Z-18125-D AT-164G	 O	G63623	58623 77623



MIRADA

08-24	MotorHomes with Ford F53 Chassis with 16,000 lb GVW to 22,000 lb GVW	ASH-1229 ASH-1228 9U94-18045-AA ASH-1205 AT-620 ASH-1022 1C34-18045-AA ASH-294 9U9Z-18124-A ASH-25822 ASH-25823 1C34-18045-JA AT-766	 OO	83209
		ASH-1206 9U94-18080-AA AT-621 ASH-25824 9U9Z-18125-A ASH-1023 ASH-1230 ASH-137	 OO	83122 89406
99-07	MotorHomes with Ford F53 Chassis with 16,000 lb GVW to 22,000 lb GVW	ASH-1229 ASH-1228 9U94-18045-AA ASH-1205 AT-620 ASH-1022 1C34-18045-AA ASH-294 9U9Z-18124-A ASH-25822 ASH-25823 1C34-18045-JA AT-766	 OO	83209
		ASH-1206 9U94-18080-AA AT-621 ASH-25824 9U9Z-18125-A ASH-1023 ASH-1230 ASH-137	 OO	83122 89406

NOVA

25	20C, Left	 O	G57800 ⁴⁰
	20C, Right	 O	G57801 ⁴⁰

APPLICATION GUIDE

Year	Fitment Notes	OEM#								
			Fleetline/ Gas SLX	Classic/ Ultra/ ProGuard/ Guardian	Max Control/ LTV Severe Duty/ Load Carrier/ Hijackers/ OffGrid Nomads	Steering Dampers/ Steering Stabilizer/ Cab Shock	Fleetline/ Gas SLX	Classic/ Ultra/ ProGuard/ Guardian	Max Control/ LTV Severe Duty/ Load Carrier/ Hijackers/ OffGrid Nomads	Steering Dampers/ Steering Stabilizer/ Cab Shock

COACHMEN

COACHMEN

PATHFINDER

98-03	MotorHomes with Ford E350 or E450 Chassis	8C2Z-18124-D 8C24-18045-DA ASH-1154 AT-163G	 O	G63622	58622 77614
		8C24-18080-DB ASH-1136 8C2Z-18125-D AT-164G	 O	G63623	58623 77623

PURSUIT

13-24	MotorHomes with Ford F53 Chassis with 16,000 lb GVW to 22,000 lb GVW	ASH-1229 ASH-1228 9U94-18045-AA ASH-1205 AT-620 ASH-1022 1C34-18045-AA ASH-294 9U9Z-18124-A ASH-25822 ASH-25823 1C34-18045-JA AT-766	 O	83209
		ASH-1206 9U94-18080-AA AT-621 ASH-25824 9U9Z-18125-A ASH-1023 ASH-1230 ASH-137	 O	 O	83122 89406
04-12	MotorHomes with Ford F53 Chassis with 16,000 lb GVW to 22,000 lb GVW	ASH-1229 ASH-1228 9U94-18045-AA ASH-1205 AT-620 ASH-1022 1C34-18045-AA ASH-294 9U9Z-18124-A ASH-25822 ASH-25823 1C34-18045-JA AT-766	 O	83209
		ASH-1206 9U94-18080-AA AT-621 ASH-25824 9U9Z-18125-A ASH-1023 ASH-1230 ASH-137	 O	 O	83122 89406

SANTARA

99-06	MotorHomes with Ford E350 or E450 Chassis	8C2Z-18124-D 8C24-18045-DA ASH-1154 AT-163G	 O	G63622	58622 77614
		8C24-18080-DB ASH-1136 8C2Z-18125-D AT-164G	 O	G63623	58623 77623

COLLINS BUS CORP.

COLLINS BUS CORP.

VARIOUS

	Type A School Bus models with Ford E350 & E450 Chassis (Up to 2022)	ASH-1154	 O	G63622	58622 77614
		ASH-1136	 O	G63623	58623 77623



DAMON

DAMON

CLASS A MOTORHOMES

04-11	Models with Workhorse W20, W22, & W24 MotorHome Chassis with O.E.M. Number	W0005663 F4-BE5-F325-HO 24-153256	 I	85124
-------	--	---	------	------	------	------	------	-------	-------	------	------	------

APPLICATION GUIDE

Year	Fitment Notes	OEM#								
			Fleetline\ Gas SLX	Classic\ Ultra\ ProGuard\ Guardian	Max Control\ LTV Severe Duty\ Load Carrier\ HIJackers\ OffGrid Nomads	Steering Dampers\ Steering Stabilizer\ Cab Shock	Fleetline\ Gas SLX	Classic\ Ultra\ ProGuard\ Guardian	Max Control\ LTV Severe Duty\ Load Carrier\ HIJackers\ OffGrid Nomads	Steering Dampers\ Steering Stabilizer\ Cab Shock

DAMON

DAMON

CLASS A MOTORHOMES (cont)

98-11	Models with Workhorse W20 , W22, & W24 MotorHome Chassis with O.E.M. Number 98 - 11	24-153249 F4-BE5-B492-HO W0005662 W0006254 24153249 24-186629 F4-BE5-A832-MO F4-BE5-F324-HO	OIO	85125
-------	---	--	-----	-------	------	------	------	------	------	------	------

DAYBREAK

12-13	MotorHomes with Ford F53 Chassis with 16,000 lb GVW to 22,000 lb GVW	ASH-1229 ASH-1228 9U94-18045-AA ASH-1205 AT-620 ASH-1022 1C34-18045-AA ASH-294 9U9Z-18124-A ASH-25822 ASH-25823 1C34-18045-JA AT-766	OIO	83209
		ASH-1206 9U94-18080-AA AT-621 ASH-25824 9U9Z-18125-A ASH-1023 ASH-1230 ASH-137	83122 89406
99	MotorHomes with Ford F53 Chassis with 16,000 lb GVW to 22,000 lb GVW	ASH-1229 ASH-1228 9U94-18045-AA ASH-1205 AT-620 ASH-1022 1C34-18045-AA ASH-294 9U9Z-18124-A ASH-25822 ASH-25823 1C34-18045-JA AT-766	OIO	83209
		ASH-1206 9U94-18080-AA AT-621 ASH-25824 9U9Z-18125-A ASH-1023 ASH-1230 ASH-137	83122 89406

INTRUDER

99	MotorHomes with Ford F53 Chassis with 16,000 lb GVW to 22,000 lb GVW	ASH-1229 ASH-1228 9U94-18045-AA ASH-1205 AT-620 ASH-1022 1C34-18045-AA ASH-294 9U9Z-18124-A ASH-25822 ASH-25823 1C34-18045-JA AT-766	OIO	83209
		ASH-1206 9U94-18080-AA AT-621 ASH-25824 9U9Z-18125-A ASH-1023 ASH-1230 ASH-137	83122 89406

APPLICATION GUIDE

Year	Fitment Notes	OEM#								
			Fleetline\ Gas SLX	Classic\ Ultra\ ProGuard\ Guardian	Max Control\ LTV Severe Duty\ Load Carrier\ Hijackers\ OffGrid Nomads	Steering Dampers\ Steering Stabilizer\ Cab Shock	Fleetline\ Gas SLX	Classic\ Ultra\ ProGuard\ Guardian	Max Control\ LTV Severe Duty\ Load Carrier\ Hijackers\ OffGrid Nomads	Steering Dampers\ Steering Stabilizer\ Cab Shock

DAMON

DAMON

OUTLAW

12-14	MotorHomes with Ford F53 Chassis with 16,000 lb GVW to 22,000 lb GVW	ASH-1229 ASH-1228 9U94-18045-AA ASH-1205 AT-620 ASH-1022 1C34-18045-AA ASH-294 9U9Z-18124-A ASH-25822 ASH-25823 1C34-18045-JA AT-766	83209								
		OO									
		ASH-1206 9U94-18080-AA AT-621 ASH-25824 9U9Z-18125-A ASH-1023 ASH-1230 ASH-137	OO								
			OO								

DIAMOND COACH

DIAMOND COACH

SHUTTLE BUSES

	All Shuttle buses with Ford E350 or E450 Chassis	8C2Z-18124-D 8C24-18045-DA ASH-1154 AT-163G	OO								
		8C24-18080-DB ASH-1136 8C2Z-18125-D AT-164G	OO								
			OO								

DODGE TRUCK

DODGE TRUCK

D SERIES- CONVENTIONAL CAB 4 X 2

74-78	D-500, D-600, D-700, D-800	3633643									
			OO								
73	D-500, D-600, D-800	2516009	OO								

LN & LNT - CONVENTIONAL CAB

64-72	LN, LV Models	2516009									
			OO								

LNT, LVT, NLT, VLT- TILT CAB 6 X 4

64-73	LNT, LVT Models	2516009									
			OO								

LS & LT-STEEL TILT CAB

73-75	LS-1000, LT-1000	2516009									
			OO								



MOTORHOME CHASSIS

77-81	M-6 Motorhome Chassis	4036892	OO								
		3638112	OO								
73-81	M & R-300, 400, 500 Motorhome Chassis	3638631	OO								
		3638112	OO								
63-72	M-300, M-375 & R-375 Motorhome Chassis	2961043 3633744	OO								

P SERIES - FORWARD CONTROL

72-82	P-300									
			OO								
63-78	P-400	OO								
63-71	PC-500 and PC-600, PD-500 and PD-600	OO								

APPLICATION GUIDE

Year	Fitment Notes	OEM#								
			Fleetline/ Gas SLX	Classic/ Ultra/ ProGuard/ Guardian	Max Control/ LTV Severe Duty/ Load Carrier/ HiJackers/ OffGrid Nomads	Steering Dampers/ Steering Stabilizer/ Cab Shock	Fleetline/ Gas SLX	Classic/ Ultra/ ProGuard/ Guardian	Max Control/ LTV Severe Duty/ Load Carrier/ HiJackers/ OffGrid Nomads	Steering Dampers/ Steering Stabilizer/ Cab Shock

DODGE TRUCK

DODGE TRUCK

SCHOOL BUSES

74-78	S-600, S-700	3633643
72-73	S-500, S-600	2516009
61-71	S-400, S-500, S-600

W-SERIES AND POWER WAGONS

74-78	W-600 Models	3633643
73	W-600 Models	2960707
		2516009
61-72	W-500, WT-500 Models

DUTCHMEN RV

DUTCHMEN RV

CLASS C MOTORHOMES

92-09	All Motorhomes with Ford E350 or E450 Chassis	8C2Z-18124-D 8C24-18045-DA ASH-1154 AT-163G
		8C24-18080-DB ASH-1136 8C2Z-18125-D AT-164G

JAMBOREE

15-20	Motorhomes with Ford E350 or E450 Chassis	8C2Z-18124-D 8C24-18045-DA ASH-1154 AT-163G
		8C24-18080-DB ASH-1136 8C2Z-18125-D AT-164G

DYNAMAX CORP

DYNAMAX CORP

FORCE HD

19-21	Models with 8000 to 16000 lb Front Axle and Taperleaf Spring	10-13760-000 471700002991 SDA471700002991
-------	--	---	-------	-------	-------	-------	-------	-------	-------	-------	-------	-------	-------

ISATA 4

18-20	MotorHomes with Ford E350 or E450 Chassis	8C2Z-18124-D 8C24-18045-DA ASH-1154 AT-163G
		8C24-18080-DB ASH-1136 8C2Z-18125-D AT-164G
92-17	MotorHomes with Ford E350 or E450 Chassis	8C2Z-18124-D 8C24-18045-DA ASH-1154 AT-163G
		8C24-18080-DB ASH-1136 8C2Z-18125-D AT-164G

ELDORADO NATIONAL

ELDORADO NATIONAL

ADVANTAGE

	Shuttle Buses with Ford E350 or E450 Chassis	8C2Z-18124-D 8C24-18045-DA ASH-1154 AT-163G
--	--	--	-------	-------	-------	-------	-------	-------	-------	-------	-------	-------	-------

APPLICATION GUIDE

Year	Fitment Notes	OEM#								
			Fleetline\ Gas SLX	Classic\ Ultra\ ProGuard\ Guardian	Max Control\ LTV Severe Duty\ Load Carrier\ Hijackers\ OffGrid Nomads	Steering Dampers\ Steering Stabilizer\ Cab Shock	Fleetline\ Gas SLX	Classic\ Ultra\ ProGuard\ Guardian	Max Control\ LTV Severe Duty\ Load Carrier\ Hijackers\ OffGrid Nomads	Steering Dampers\ Steering Stabilizer\ Cab Shock

ELDORADO NATIONAL

ELDORADO NATIONAL

ADVANTAGE (cont)

	Shuttle Buses with Ford E350 or E450 Chassis	8C24-18080-DB ASH-1136 8C2Z-18125-D AT-164G	G63623	58623 77623		...

AEROLITE

	Shuttle Buses with Ford E350 or E450 Chassis	8C2Z-18124-D 8C24-18045-DA ASH-1154 AT-163G		...	G63622	58622 77614		
		8C24-18080-DB ASH-1136 8C2Z-18125-D AT-164G							G63623	58623 77623		

AEROTECH

	Shuttle Buses with Ford E350 or E450 Chassis	8C2Z-18124-D 8C24-18045-DA ASH-1154 AT-163G			G63622	58622 77614						
		8C24-18080-DB ASH-1136 8C2Z-18125-D AT-164G							G63623	58623 77623		

EMERGENCY ONE

EMERGENCY ONE

VARIOUS

	AERM Models with 10K Front Leaf Spring	90-2572		85329								
	AERM Models with 21K Front Taper-Leaf Spring	90-2572		85329								
	PAEM Models with 19K Front Taper-Leaf Spring	90-2572		85329								
	PMPR Models with 19K Front Taper-Leaf Spring	90-2572		85329								

ENTEGRA COACH

ENTEGRA COACH



ESTEEM

18-24	MotorHomes with Ford E350 or E450 Chassis	8C2Z-18124-D 8C24-18045-DA ASH-1154 AT-163G			G63622	58622 77614						
		8C24-18080-DB ASH-1136 8C2Z-18125-D AT-164G							G63623	58623 77623		
17	MotorHomes with Ford E350 or E450 Chassis	8C2Z-18124-D 8C24-18045-DA ASH-1154 AT-163G			G63622	58622 77614						
		8C24-18080-DB ASH-1136 8C2Z-18125-D AT-164G							G63623	58623 77623		

ODYSSEY

25-26	Motorhomes with Ford E450 Chassis	8C2Z-18125-D										
	24B, 30Z, Motorhomes with Ford E450 Chassis	8C2Z-18124-D				77614						
26	24B, With Ford E-450 Super Duty	8C2Z-18124-D				58622						
	24B, With Ford E-450 Super Duty Medium Duty				G63622							
	24B, 30Z, Motorhomes with Ford E450 Chassis	8C2Z-18125-D							61646	77623		
	24B, 30Z, With Ford E-450 Super Duty	8C2Z-18125-D							G63623	58623		

APPLICATION GUIDE

Year	Fitment Notes	OEM#								
			Fleetline\ Gas SLX	Classic\ Ultra\ ProGuard\ Guardian	Max Control\ LTV Severe Duty\ Load Carrier\ HiJackers\ OffGrid Nomads	Steering Dampers\ Steering Stabilizer\ Cab Shock	Fleetline\ Gas SLX	Classic\ Ultra\ ProGuard\ Guardian	Max Control\ LTV Severe Duty\ Load Carrier\ HiJackers\ OffGrid Nomads	Steering Dampers\ Steering Stabilizer\ Cab Shock

ENTEGRA COACH

ODYSSEY (cont)

26	30Z, With Ford E-450 Super Duty	8C2Z-18124-D	I O	G63622	58622
25	30Z, Motorhomes with Ford E450 Chassis	8C2Z-18125-D	I O	77623
18-24	MotorHomes with Ford E350 or E450 Chassis	8C2Z-18124-D 8C24-18045-DA ASH-1154 AT-163G	I O	G63622	58622 77614
		8C24-18080-DB ASH-1136 8C2Z-18125-D AT-164G	I O	G63623	58623 77623
17	MotorHomes with Ford E350 or E450 Chassis	8C2Z-18124-D 8C24-18045-DA ASH-1154 AT-163G	I O	G63622	58622 77614
		8C24-18080-DB ASH-1136 8C2Z-18125-D AT-164G	I O	G63623	58623 77623

ENTEGRA COACH

ODYSSEY SE

23-24	MotorHomes with Ford E450 Chassis	8C2Z-18124-D 8C24-18045-DA ASH-1154 AT-163G	I O	G63622	58622 77614
		8C24-18080-DB ASH-1136 8C2Z-18125-D AT-164G	I O	G63623	58623 77623

FEDERAL COACH

VARIOUS

	Spirit Series Shuttle buses with Ford E450 Chassis To 2020	ASH-1154	I O	G63622	58622 77614
		ASH-1136	I O	G63623	58623 77623
09-19	Shuttle buses with Freightliner M2-106 Chassis	10-13760-000 471700002991 SDA471700002991	O O	85959
02-19	Shuttle buses with Freightliner M2-106 Chassis	16-18708-000 471700002809	O O	85724 89443
02-08	Shuttle buses with Freightliner M2-106 Chassis	10-12388-000 10-12390-000	O O	85920

FEDERAL COACH

FLEETWOOD

AXON

19-20	MotorHomes with Ford F53 Chassis with 16,000 lb GVW to 22,000 lb GVW	ASH-1229 ASH-1228 9U94-18045-AA ASH-1205 AT-620 ASH-1022 1C34-18045-AA ASH-294 9U9Z-18124-A ASH-25822 ASH-25823 1C34-18045-JA AT-766	O O	83209
		ASH-1206 9U94-18080-AA AT-621 ASH-25824 9U9Z-18125-A ASH-1023 ASH-1230 ASH-137	O O	83122 89406

FLEETWOOD

APPLICATION GUIDE

Year	Fitment Notes	OEM#	 Fleetline\ Gas SLX Classic\ Ultra\ ProGuard\ Guardian Max Control\ LTV Severe Duty\ Load Carrier\ Hijackers\ OffGrid Nomads Steering Dampers\ Steering Stabilizer\ Cab Shock				 Fleetline\ Gas SLX Classic\ Ultra\ ProGuard\ Guardian Max Control\ LTV Severe Duty\ Load Carrier\ Hijackers\ OffGrid Nomads Steering Dampers\ Steering Stabilizer\ Cab Shock			
			Fleetline\ Gas SLX	Classic\ Ultra\ ProGuard\ Guardian	Max Control\ LTV Severe Duty\ Load Carrier\ Hijackers\ OffGrid Nomads	Steering Dampers\ Steering Stabilizer\ Cab Shock	Fleetline\ Gas SLX	Classic\ Ultra\ ProGuard\ Guardian	Max Control\ LTV Severe Duty\ Load Carrier\ Hijackers\ OffGrid Nomads	Steering Dampers\ Steering Stabilizer\ Cab Shock

FLEETWOOD

FLEETWOOD

CLASS A MOTORHOMES

04-11	Models with Workhorse W20, W22, & W24 MotorHome Chassis with O.E.M. Number	W0005663 F4-BE5-F325-HO 24-153256								85124			
-------	--	---	--	--	--	--	--	--	--	-------	--	--	--

JAMBOREE

20	MotorHomes with Ford E350 or E450 Chassis	8C2Z-18124-D 8C24-18045-DA ASH-1154 AT-163G			G63622	58622 77614							
		8C24-18080-DB ASH-1136 8C2Z-18125-D AT-164G								G63623	58623 77623		
17-19	MotorHomes with Ford E350 or E450 Chassis	8C2Z-18124-D 8C24-18045-DA ASH-1154 AT-163G			G63622	58622 77614							
		8C24-18080-DB ASH-1136 8C2Z-18125-D AT-164G								G63623	58623 77623		
14-16	MotorHomes with Ford E350 or E450 Chassis	8C2Z-18124-D 8C24-18045-DA ASH-1154 AT-163G			G63622	58622 77614							
		8C24-18080-DB ASH-1136 8C2Z-18125-D AT-164G								G63623	58623 77623		
08-13	MotorHomes with Ford E350 or E450 Chassis	8C2Z-18124-D 8C24-18045-DA ASH-1154 AT-163G			G63622	58622 77614							
		8C24-18080-DB ASH-1136 8C2Z-18125-D AT-164G								G63623	58623 77623		
99-07	MotorHomes with Ford E350 or E450 Chassis	8C2Z-18124-D 8C24-18045-DA ASH-1154 AT-163G			G63622	58622 77614							
		8C24-18080-DB ASH-1136 8C2Z-18125-D AT-164G								G63623	58623 77623		



SURGE

19-20	MotorHomes with Ford E350 or E450 Chassis	8C2Z-18124-D 8C24-18045-DA ASH-1154 AT-163G			G63622	58622 77614							
		8C24-18080-DB ASH-1136 8C2Z-18125-D AT-164G								G63623	58623 77623		
18	MotorHomes with Ford E350 or E450 Chassis	8C2Z-18124-D 8C24-18045-DA ASH-1154 AT-163G			G63622	58622 77614							
		8C24-18080-DB ASH-1136 8C2Z-18125-D AT-164G								G63623	58623 77623		

TIOGA

14-16	MotorHomes with Ford E350 or E450 Chassis	8C2Z-18124-D 8C24-18045-DA ASH-1154 AT-163G			G63622	58622 77614							
		8C24-18080-DB ASH-1136 8C2Z-18125-D AT-164G								G63623	58623 77623		

APPLICATION GUIDE

Year	Fitment Notes	OEM#								
			Fleetline\ Gas SLX	Classic\ Ultra\ ProGuard\ Guardian	Max Control\ LTV Severe Duty\ Load Carrier\ HiJackers\ OffGrid Nomads	Steering Dampers\ Steering Stabilizer\ Cab Shock	Fleetline\ Gas SLX	Classic\ Ultra\ ProGuard\ Guardian	Max Control\ LTV Severe Duty\ Load Carrier\ HiJackers\ OffGrid Nomads	Steering Dampers\ Steering Stabilizer\ Cab Shock

FLEETWOOD

FLEETWOOD

TIOGA (cont)

08-13	MotorHomes with Ford E350 or E450 Chassis	8C2Z-18124-D 8C24-18045-DA ASH-1154 AT-163G	 O	G63622	58622 77614
		8C24-18080-DB ASH-1136 8C2Z-18125-D AT-164G	 O	G63623	58623 77623
99-07	MotorHomes with Ford E350 or E450 Chassis	8C2Z-18124-D 8C24-18045-DA ASH-1154 AT-163G	 O	G63622	58622 77614
		8C24-18080-DB ASH-1136 8C2Z-18125-D AT-164G	 O	G63623	58623 77623

FORD

FORD

C & CT SERIES - TILT CAB

64-67	C-550, C-600 with 6000 lb. Axle - Exc. with Power Steering	C6PF-18077-A	 O	G63306
-------	--	--------------	-------	------	--------	------	------	------	------	------

C600

80-86	Models with 3100 lb Spring and 7000 lb Axle	D7HT-18045-JA	 O	83308
	Models with 4040, 5040 lb Springs and 7000, 9000, 12000 lb Axles	D2EF-18045-AA	 O	83312

E-450 ECONOLINE SUPER DUTY

00-02	All		 O	G63622	58622 77614 NM1005	61646 G63623	58623 NM1010
	Exc. Cutaway Chassis		 O	77623
	Single System Steering Stabilizer		 O	6828SE ⁸⁰							

E-550 ECONOLINE SUPER DUTY

02	All		 O	61655
	Single System Steering Stabilizer		 O	6828SE ⁸⁰							

E-550 SUPER DUTY



03	All		 O	61655
	Single System Steering Stabilizer		 O	6828SE ⁸⁰							

F-53

08-23	F53 Chassis with 24,000 lb GVW to 26,000 lb GVW	ASH-25821 ASH-1161 HU9Z-18124-A	 O	85006	
		ASH-25820 ASH-1162	 O	85005 89430
06-23	F-53 Chassis with 16,000 lb GVW to 18,000 lb GVW	ASH-1206 9U94-18080-AA 9U9Z-18125-B AT-621 ASH-25825 ASH-25824 9U9Z-18125-A ASH-1023 ASH-1230 ASH-137 HU9Z-18125-B	 O	83122 89406

⁸⁰ Mounting bracket not required, install on O.E. Shock Mounts. See Ref. C for

APPLICATION GUIDE

Year	Fitment Notes	OEM#								
			Fleetline\ Gas SLX	Classic\ Ultra\ ProGuard\ Guardian	Max Control\ LTV Severe Duty\ Load Carrier\ Hijackers\ OffGrid Nomads	Steering Dampers\ Steering Stabilizer\ Cab Shock	Fleetline\ Gas SLX	Classic\ Ultra\ ProGuard\ Guardian	Max Control\ LTV Severe Duty\ Load Carrier\ Hijackers\ OffGrid Nomads	Steering Dampers\ Steering Stabilizer\ Cab Shock

FORD

FORD



F-53 (cont)

06-23	F53 Chassis with 16,000 lb GVW to 22,000 lb GVW	ASH-1229 HU94-18045-AA ASH-1228 9U94-18045-AA ASH-1205 AT-620 ASH-1022 HU9Z-18124-B HU9Z-18124-C HU94-18045-BA ASH-294 9U9Z-18124-A 9U9Z-18124-B ASH-25822 ASH-25823 1C34-18045-JA AT-766	OIO	83209				
11-20	F53 Stripped Chassis Commercial Stripped Chassis, 19,500 lb to 22,000 lb GVW	471700007203 ASH-24634 DU94-18045-CB	OIO	85013
	F53 Stripped Chassis With BT Delivery Van Pack, 16,000 LB. GVW	471700009775 DU94-18080-CA 471700007117 DU94-18080-CB	OIO	85010
99-04	F-53 Chassis with 16,000 lb GVW to 18,000 lb GVW	ASH-1206 9U94-18080-AA AT-621 ASH-25824 9U9Z-18125-A ASH-1023 ASH-1230 ASH-137 HU9Z-18125-B	OIO	83122 89406
	F53 Chassis with 16,000 lb GVW to 22,000 lb GVW	ASH-1229 HU94-18045-AA ASH-1228 9U94-18045-AA ASH-1205 AT-620 ASH-1022 HU9Z-18124-B HU9Z-18124-C HU94-18045-BA ASH-294 9U9Z-18124-A 9U9Z-18124-B ASH-25822 ASH-25823 1C34-18045-JA AT-766	OIO	83209
88-97	F53 Chassis with 16,000 lb GVW to 22,000 lb GVW	ASH-1229 HU94-18045-AA ASH-1228 9U94-18045-AA ASH-1205 AT-620 ASH-1022 HU9Z-18124-B HU9Z-18124-C HU94-18045-BA ASH-294 9U9Z-18124-A 9U9Z-18124-B ASH-25822 ASH-25823 1C34-18045-JA AT-766	OIO	83209

F-53 MOTORHOME CHASSIS

24	MotorHomes with Ford F53 Chassis with 24,000 lb GVW to 26,000 lb GVW	ASH-25821 ASH-1161 HU9Z-18124-A	OIO	85006				
----	--	---------------------------------------	-----	-------	------	------	------	--	--	--	--

APPLICATION GUIDE

Year	Fitment Notes	OEM#								
			Fleetline\ Gas SLX	Classic\ Ultra\ ProGuard	Max Control\ LTV Severe Duty\ Load Carrier\ HiJackers\ OffGrid Nomads	Steering Dampers\ Steering Stabilizer\ Cab Shock	Fleetline\ Gas SLX	Classic\ Ultra\ ProGuard	Max Control\ LTV Severe Duty\ Load Carrier\ HiJackers\ OffGrid Nomads	Steering Dampers\ Steering Stabilizer\ Cab Shock

FORD

FORD

F-53 MOTORHOME CHASSIS (cont)

05	MotorHomes with Ford F53 Chassis with 16,000 lb GVW to 22,000 lb GVW	ASH-1229 ASH-1228 9U94-18045-AA ASH-1205 AT-620 ASH-1022 1C34-18045-AA ASH-294 9U9Z-18124-A ASH-25822 ASH-25823 1C34-18045-JA AT-766	OO	83209
98	MotorHomes with Ford F53 Chassis with 16,000 lb GVW to 22,000 lb GVW	ASH-1229 ASH-1228 9U94-18045-AA ASH-1205 AT-620 ASH-1022 1C34-18045-AA ASH-294 9U9Z-18124-A ASH-25822 ASH-25823 1C34-18045-JA AT-766	OO	83209

F-59 COMMERCIAL STRIPPED CHASSIS

11-24	MotorHomes with Ford F59 Commercial Chassis with 24,000 lb GVW to 26,000 lb GVW	ASH-25821 ASH-1161 HU9Z-18124-A	OO	85006
11-21	F59 Commercial Chassis with 16,000 lb or 19,500 GVW	471700009775 CU9Z-18125-A ASH-12261 ASH-24523 ASH-24589 DU94-18080-CA BU9Z-18125-A 471700007117 ASH-24474 DU94-18080-CB DU9Z-18125-A DU9Z-18125-B	OO	85010	85010
	F59 Commercial Chassis with 16,000 lb to 22,000 GVW	ASH-12251 CU9Z-18124-A ASH-24473 BU9Z-18124-A ASH-24522 ASH-24634 DU9Z-18124-A DU9Z-18124-B	OO	85013
89-97	F59 Commercial Chassis with 16,000 lb or 19,500 GVW	471700009775 CU9Z-18125-A ASH-12261 ASH-24523 ASH-24589 DU94-18080-CA BU9Z-18125-A 471700007117 ASH-24474 DU94-18080-CB DU9Z-18125-A DU9Z-18125-B	OO	85010	85010
	F59 Commercial Chassis with 16,000 lb to 22,000 GVW	ASH-12251 CU9Z-18124-A ASH-24473 BU9Z-18124-A ASH-24522 ASH-24634 DU9Z-18124-A DU9Z-18124-B	OO	85013

F-600

86-94	Models with O.E.M. Number	AX-310 ASH-24446 E6HT-18080-AA E6HZ-18125-D	OO	83215
80-94	Exc. 9000 lb Axle with H.D. Suspension & 12000 lb Axle	E0HT-18045-AB E0HT-18045-AA	OO	83309

APPLICATION GUIDE

Year	Fitment Notes	OEM#								
			Fleetline\ Gas SLX	Classic\ Ultra\ ProGuard\ Guardian	Max Control\ LTV Severe Duty\ Load Carrier\ Hijackers\ OffGrid Nomads	Steering Dampers\ Steering Stabilizer\ Cab Shock	Fleetline\ Gas SLX	Classic\ Ultra\ ProGuard\ Guardian	Max Control\ LTV Severe Duty\ Load Carrier\ Hijackers\ OffGrid Nomads	Steering Dampers\ Steering Stabilizer\ Cab Shock

FORD

FORD

F-600 (cont)

80-90	Models with 17000 & 18000 lb Rear Axle	D7HT-18080-DA D7HF-18080-AA	OIO	83215
70-90	Models with 13000 & 15000 lb Rear Axle	D7HT-18080-BA	OIO	83225
90	Models with Multileaf Spring	F1HT-18045-AA	OIO	83309
83-89	Models with 9000 lb Axle with H.D. Suspension & 12000 lb Axle	D7HT-18045-CA D2HF-18045-AA	OIO	83314

F-600 LPO

90-94	Models with O.E.M. Number	E9HS-18080-AA	OIO	85716
-------	---------------------------	---------------	-----	-------	-----	-----	-----	-----



F-600 SUPER DUTY

20-24	All	KC3Z-3E651-C	OIO	14072
	Applications with OEM Number	PC3Z-18124-AGA PC3Z-18124-ARA PC3Z-18124-AKA	OIO	G63622
		PC3Z-18124-SBA, PC3Z-18124-JA	OIO	G63886	77967
	4 X 2, Models with RWD and OEM number	HC3Z-18125-B, HC3Z-18125-ED, EC3Z-18125-EE, EC3Z-18125-EF, PC3Z-18125-CFA, PC3Z-18125-CEA	OIO	77987

F-650

21-24	Models with 19.5" or 22.5" Wheels (22,000 lb GVW)	FC4Z-18124-B FC4Z-18124-A ASH-24659 ASH-24658 471700011530 FC44-18045-BB	OIO	85181
	Models with 13,500, 15,500 & 19,000 lb Multi-leaf Rear Springs	FC4Z-18125-A ASH-24660 471700011531 FC44-18080-AB	OIO	85180	
	Models with Hendrickson HAS - 400/460 Rear Air Suspension	60675-014 ASH-25838 FC4Z-18125-E	OIO	85978	
	Models with Hendrickson Rear Air Suspension	60670-011 FC4Z-18125-D ASH-24663	OIO	83148	
20	Models with Hendrickson Rear Air Suspension	60670-012 ASH-24662 FC4Z-18125-C	OIO	83168	
15-19	Models with 19.5" or 22.5" Wheels (22,000 lb GVW)	FC4Z-18124-B FC4Z-18124-A ASH-24659 ASH-24658 471700011530 FC44-18045-BB	OIO	85181
	Models with 13,500, 15,500 & 19,000 lb Multi-leaf Rear Springs	FC4Z-18125-A ASH-24660 471700011531 FC44-18080-AB	OIO	85180	
	Models with Hendrickson HAS - 400/460 Rear Air Suspension	60675-014 ASH-25838 FC4Z-18125-E	OIO	85978	
	Models with Hendrickson Rear Air Suspension	60670-011 FC4Z-18125-D ASH-24663	OIO	83148	
		60670-012 ASH-24662 FC4Z-18125-C	OIO	83168	

APPLICATION GUIDE

Year	Fitment Notes	OEM#								
			Fleetline\ Gas SLX	Classic\ Ultra\ ProGuard\ Guardian	Max Control\ LTV Severe Duty\ Load Carrier\ HiJackers\ OffGrid Nomads	Steering Dampers\ Steering Stabilizer\ Cab Shock	Fleetline\ Gas SLX	Classic\ Ultra\ ProGuard\ Guardian	Max Control\ LTV Severe Duty\ Load Carrier\ HiJackers\ OffGrid Nomads	Steering Dampers\ Steering Stabilizer\ Cab Shock



FORD

FORD

F-650 (cont)

15	Models with 10,000 lb Front Suspension	3584116C1 3584116C2 ASH-24492 AA-616 2C44-18045-BA 4C4Z-18124-QA	O/O	83175
	Models with 12,000 & 13,200 lb Front Springs	4C4Z-18124-JB 3584118C2 AA-617 4C4Z-18124-RA AT-812	O/O	85928
	Models with 21,000 lb Rear Air Suspension	3578858C1 3578858C2 4C4Z-18125-DA	O/O	85656
	Models with 22,000 lb Multi-leaf Rear Springs	4C4Z-18125-B 501906C91 501906C92 ASH-24661	O/O	83317
	Models with 8,500 lb Front Suspension	4C4Z-18124-HB AA-615 FC4Z-18124-HB 3584117C2 4C4Z-18124-P AT-811	O/O	83135
	Models with Hendrickson HAS - 230 Rear Air Suspension	4C4Z-18125-CA 60675-003 ASH-1105 ASH-722 60675-003L	O/O	85976
	Models with International Air Suspension (4x2)	AA-619 3553628C1 3553628C2	O/O	85927
14	Models with 10,000 lb Front Suspension	3584116C1 3584116C2 ASH-24492 AA-616 2C44-18045-BA 4C4Z-18124-QA	O/O	83175
	Models with 12,000 & 13,200 lb Front Springs	4C4Z-18124-JB 3584118C2 AA-617 4C4Z-18124-RA AT-812	O/O	85928
	Models with 21,000 lb Rear Air Suspension	3578858C1 3578858C2 4C4Z-18125-DA	O/O	85656
	Models with 22,000 lb Multi-leaf Rear Springs	4C4Z-18125-B 501906C91 501906C92 ASH-24661	O/O	83317
	Models with 8,500 lb Front Suspension	4C4Z-18124-HB AA-615 FC4Z-18124-HB 3584117C2 4C4Z-18124-P AT-811	O/O	83135
	Models with Hendrickson HAS - 230 Rear Air Suspension	4C4Z-18125-CA 60675-003 ASH-1105 ASH-722 60675-003L	O/O	85976
	Models with International Air Suspension (4x2)	AA-619 3553628C1 3553628C2	O/O	85927
04-13	Models with 21,000 lb Rear Air Suspension	3578858C1 3578858C2 4C4Z-18125-DA	O/O	85656
	Models with 22,000 lb Multi-leaf Rear Springs	4C4Z-18125-B 501906C91 501906C92 ASH-24661	O/O	83317
	Models with Hendrickson HAS - 230 Rear Air Suspension	4C4Z-18125-CA 60675-003 ASH-1105 ASH-722 60675-003L	O/O	85976

APPLICATION GUIDE

Year	Fitment Notes	OEM#								
			Fleetline\ Gas SLX	Classic\ Ultra\ ProGuard\ Guardian	Max Control\ LTV Severe Duty\ Load Carrier\ Hijackers\ OffGrid Nomads	Steering Dampers\ Steering Stabilizer\ Cab Shock	Fleetline\ Gas SLX	Classic\ Ultra\ ProGuard\ Guardian	Max Control\ LTV Severe Duty\ Load Carrier\ Hijackers\ OffGrid Nomads	Steering Dampers\ Steering Stabilizer\ Cab Shock

FORD

FORD

F-650 (cont)

04-13	Models with International Air Suspension (4x2)	AA-619 3553628C1 3553628C2	010	85927	010	85927
02-13	Models with Vari-Rate Rear Suspension	AA-620 4C4Z-18125-CC	010	83101	010	83101
00-13	Models with 10,000 lb Front Suspension	3584116C1 3584116C2 ASH-24492 AA-616 2C44-18045-BA 4C4Z-18124-QA	010	83175	010	83175
	Models with 12,000 & 13,200 lb Front Springs	4C4Z-18124-JB 3584118C2 AA-617 4C4Z-18124-RA AT-812	010	85928	010	85928
	Models with 8,500 lb Front Suspension	4C4Z-18124-HB AA-615 FC4Z-18124-HB 3584117C2 4C4Z-18124-P AT-811	010	83135	010	83135
00-03	Models with 23,000 lb Multi-leaf Rear Springs	F81Z-18125-ZA AT-696 AT696 ASH-2447 F81A-18080-ZC	010	83140	010	83140
	Models with Hendrickson HAS - 190 Rear Air Suspension	1C44-18080-AA 60670-008 60670-008L	010	83123 89405	010	83123 89405
00-02	Models with 8500 or 9000 lb Front Axle	XC35-18045-JA AA-494 ASH-397 3U2Z-18124-MAA XC35-18045-AB XC3Z-18124-JA XC35-18045-AD	010	83131	010	83131

F-SUPER DUTY

93-97	Mfg. from 2/93		010	G63692	010	G63692
88-97	All		010	61554 81710 G63409	010	61554 81710 G63409
	Quad Suspension; Rearward of Front Axle		010	43167 ⁸	010	43167 ⁸
90-92	Single System Steering Stabilizer All models with factory frame bracket. Kit 143168 required to install to linkage.		010	6802SE ⁸⁴	010	6802SE ⁸⁴

LCF450

06-09	w/ vari-rate suspension w/ vari-rate suspension	6E7Z-18125-A	010	83364	010	83364
-------	---	--------------	-----	-------	-----	-----	-----	-----	-----	-------	-----	-----	-----

LCF550

06-09	w/ vari-rate suspension w/ vari-rate suspension	6E7Z-18125-A	010	83364	010	83364
-------	---	--------------	-----	-------	-----	-----	-----	-----	-----	-------	-----	-----	-----



LN600

80-85	Models with 11000, 13000, 15000, 17000 lb Axles	D7HT-18080-BA	010	83225	010	83225
	Models with 3000, 3300 lb Springs and 5000, 5500, 6000, 7000 lb Axles	D7HT-18045-GA	010	83308	010	83308
	Models with 4400 lb Spring and 7000, 9000 lb Axles	D2EF-18045-AA	010	83312	010	83312

PICKUP, F-450 SUPERDUTY

17-24	4 X 4		010	14072	010	14072
-------	-------	--	-----	-------	-----	-----	-----	-----	-----	-------	-----	-----	-----

APPLICATION GUIDE

Year	Fitment Notes	OEM#								
			Fleetline\ Gas SLX	Classic\ Ultra\ ProGuard\ Guardian	Max Control\ LTV Severe Duty\ Load Carrier\ HiJackers\ OffGrid Nomads	Steering Dampers\ Steering Stabilizer\ Cab Shock	Fleetline\ Gas SLX	Classic\ Ultra\ ProGuard\ Guardian	Max Control\ LTV Severe Duty\ Load Carrier\ HiJackers\ OffGrid Nomads	Steering Dampers\ Steering Stabilizer\ Cab Shock

FORD

FORD

PICKUP, F-450 SUPERDUTY (cont)

24	All	PC3Z-18124-CGA, PC3Z-18124-HA, PC3Z-18124-ARA, PC3Z-18124-SGA	I O	77967
	4 X 4, Models with 4WD and OEM number	ASH-85927 LC3Z-18125-W ASH-866127 ASH-866139 HC3Z-18125-EP HC3Z-18125-X PC3Z-18125-F ASH-85789	O O	77986
	RWD, Models with RWD and OEM number	HC3Z-18125-ED HC3Z-18125-EE HC3Z-18125-B ASH-85857	O O	77987
17-23	Models with 4WD and OEM number	ASH-85927 LC3Z-18125-W ASH-866127 ASH-866139 LC3Z-18125-J HC3Z-18125-EP HC3Z-18125-X ASH-85789	O O	77986
	Models with RWD and OEM number	ASH-25770 HC3Z-18125-ED HC3Z-18125-EE HC3Z-18125-B ASH-85857 ASH-85856	O O	77987
13-23	All		I O	77967
13-16	4 X 2		O O	77968
	4 X 4		O O	14072	77969
09-12	All		O O	58944
08-12	4 X 4		O O	14072
07-08	All		I O	G63969	58944 77967
05-07	4 X 2		O O	77968
	4 X 4		O O	77969
99-07	Models with single or dual rear wheels with 165" or 201" wheel base	AT-611 F81A-18080-DCA AT-610 ASH-23488 ASH-247 F81Z-18125-DC ASH-23486	O O	G63461
05-06	All		I O	G63969	77967
99-04	All		O O	61655 G63809	58809 77809	77461
	4 X 4, Single System Steering Stabilizer		O O	6854SE ⁸⁰						
97	All		O O	G63692	61554 G63409
	Quad Suspension; Rearward of Front Axle		O O	43167 ⁸

PICKUP, F-550 SUPERDUTY

17-24	4 X 4		O O	14072
24	All	PC3Z-18124-CGA, PC3Z-18124-HA, PC3Z-18124-ARA, PC3Z-18124-SGA	I O	77967

8 Pair Packs.;

80 Mounting bracket not required, install on O.E. Shock Mounts. See Ref. C for optional Steering Stabilizer Boots.;

APPLICATION GUIDE

Year	Fitment Notes	OEM#								
			Fleetline\ Gas SLX	Classic\ Ultra\ ProGuard\ Guardian	Max Control\ LTV Severe Duty\ Load Carrier\ Hijackers\ OffGrid Nomads	Steering Dampers\ Steering Stabilizer\ Cab Shock	Fleetline\ Gas SLX	Classic\ Ultra\ ProGuard\ Guardian	Max Control\ LTV Severe Duty\ Load Carrier\ Hijackers\ OffGrid Nomads	Steering Dampers\ Steering Stabilizer\ Cab Shock

FORD

FORD

PICKUP, F-550 SUPERDUTY (cont)

24	4 X 4, Models with 4WD and OEM number	ASH-85927 LC3Z-18125-W ASH-866127 ASH-866139 HC3Z-18125-EP HC3Z-18125-X PC3Z-18125-F ASH-85789	 	 	 	 	 	 	 	 	 	 	 	77986	
	RWD, Models with RWD and OEM number	ASH-25770 HC3Z-18125-ED HC3Z-18125-EE HC3Z-18125-B ASH-85857 ASH-85856	 	 	 	 	 	 	 	 	 	 	 	77987	
17-23	Models with 4WD and OEM number	ASH-85927 LC3Z-18125-W ASH-866127 ASH-866139 LC3Z-18125-J HC3Z-18125-EP HC3Z-18125-X ASH-85789	 	 	 	 	 	 	 	 	 	 	 	77986	
	Models with RWD and OEM number	ASH-25770 HC3Z-18125-ED HC3Z-18125-EE HC3Z-18125-B ASH-85857 ASH-85856	 	 	 	 	 	 	 	 	 	 	 	77987	
13-23	All		 	 	 	 	 	 	 	 	 	 	 	77967	
13-16	4 X 2		 	 	 	 	 	 	 	 	 	 	 	77968	
	4 X 4		 	 	 	 	 	 	 	 	 	 	 	77969	
10-12	All		 	 	 	 	 	 	 	 	 	 	 	58944	
08-12	4 X 4		 	 	 	 	 	 	 	 	 	 	 	14072	
05-07	All		 	 	 	 	 	 	 	 	 	 	 	G63969	
	4 X 2		 	 	 	 	 	 	 	 	 	 	 	77967	
	4 X 4		 	 	 	 	 	 	 	 	 	 	 	77968	
99-07	Models with single or dual rear wheels with 165" or 201" wheel base	AT-611 F81A-18080-DCA AT-610 ASH-23488 ASH-247	 	 	 	 	 	 	 	 	 	 	 	G63461	
		F81Z-18125-DC ASH-23486	 	 	 	 	 	 	 	 	 	 	 	 	
99-04	All		 	 	 	 	 	 	 	 	 	 	 	61655 G63809	
	4 X 4, Single System Steering Stabilizer		 	6854SE ⁸⁰									 	 	77809

VAN 1 TON, ECONOLINE / CLUB WAGON / SUPERDUTY



25-26	All	8C2Z-18124-D	 	 	 	 	 	 	 	 	 	 	 	 	 	 	 	 	 	 	 		
21-24	Single System Steering Stabilizer		 	6828SE ⁸⁰																			
24	All	8C2Z18124D	 	 	 	 	 	 	 	 	 	 	 	 	 	 	 	 	 	 	 	 	
		8C2Z18125D	 	 	 	 	 	 	 	 	 	 	 	 	 	 	 	 	 	 	 	 	
21-23	All		 	 	 	 	 	 	 	 	 	 	 	 	 	 	 	 	 	 	 	 	

7 Pair Packs, Air hose kit included.;

48 Installation Hardware Included;

80 Mounting bracket not required, install on O.E. Shock Mounts. See Ref. C for optional Steering Stabilizer Boots.;

APPLICATION GUIDE

Year	Fitment Notes	OEM#								
			Fleetline\ Gas SLX	Classic\ Ultra\ ProGuard\ Guardian	Max Control\ LTV Severe Duty\ Load Carrier\ HiJackers\ OffGrid Nomads	Steering Dampers\ Steering Stabilizer\ Cab Shock	Fleetline\ Gas SLX	Classic\ Ultra\ ProGuard\ Guardian	Max Control\ LTV Severe Duty\ Load Carrier\ HiJackers\ OffGrid Nomads	Steering Dampers\ Steering Stabilizer\ Cab Shock

FORD

FORD

VAN 1 TON, ECONOLINE / CLUB WAGON / SUPERDUTY (cont)

10-19	All		 O	81744 ⁴⁸ G63622	34076 ⁸ 58622 77614 NM1005	 O	61646 81828 G63623	49178 ⁷ 58623 NM1010
03-19	Exc. Cutaway Chassis		 O	 O	77623
	Single System Steering Stabilizer		 O	6828SE ⁸⁰								
03-09	All		 O	G63622	58622 77614 NM1005	 O	61646 G63623	58623 NM1010

FOREST RIVER

FOREST RIVER

ALL AMERICAN

	MotorHomes with Ford E350 or E450 Chassis	8C2Z-18124-D 8C24-18045-DA ASH-1154 AT-163G	 O	G63622	58622 77614	 O
		8C24-18080-DB ASH-1136 8C2Z-18125-D AT-164G	 O	 O	G63623	58623 77623

CLASS A MOTORHOMES

	MotorHomes with Workhorse UFO Chassis with Hendrickson Softek Front Suspension	66153-002 F4-BE5-C832-MO	 O	83124	 O
--	--	-----------------------------	-------	-------	------	------	------	-------	------	------	------	------

FORESTER

20	MotorHomes with Ford E350 or E450 Chassis	8C2Z-18124-D 8C24-18045-DA ASH-1154 AT-163G	 O	G63622	58622 77614	 O
		8C24-18080-DB ASH-1136 8C2Z-18125-D AT-164G	 O	 O	G63623	58623 77623
04-19	MotorHomes with Ford E350 or E450 Chassis	8C2Z-18124-D 8C24-18045-DA ASH-1154 AT-163G	 O	G63622	58622 77614	 O
		8C24-18080-DB ASH-1136 8C2Z-18125-D AT-164G	 O	 O	G63623	58623 77623

FORESTER GTS

15-18	MotorHomes with Ford E350 or E450 Chassis	8C2Z-18124-D 8C24-18045-DA ASH-1154 AT-163G	 O	G63622	58622 77614	 O
		8C24-18080-DB ASH-1136 8C2Z-18125-D AT-164G	 O	 O	G63623	58623 77623

FORESTER TS

17-22	MotorHomes with Ford Transit-350 Chassis		 O	G57816 ⁶⁰	 O	G64177
-------	--	--	-------	------	----------------------	------	------	-------	------	--------	------	------

7 Pair Packs, Air hose kit included.;

40 Complete Assembled Unit.;

80 Mounting bracket not required, install on O.E. Shock Mounts. See Ref. C for

8 Pair Packs.;

48 Installation Hardware Included.;

APPLICATION GUIDE

Year	Fitment Notes	OEM#								
			Fleetline\ Gas SLX	Classic\ Ultra\ ProGuard\ Guardian	Max Control\ LTV Severe Duty\ Load Carrier\ Hijackers\ OffGrid Nomads	Steering Dampers\ Steering Stabilizer\ Cab Shock	Fleetline\ Gas SLX	Classic\ Ultra\ ProGuard\ Guardian	Max Control\ LTV Severe Duty\ Load Carrier\ Hijackers\ OffGrid Nomads	Steering Dampers\ Steering Stabilizer\ Cab Shock

FOREST RIVER

FOREST RIVER

FR3

13-24	MotorHomes with Ford F53 Chassis with 16,000 lb GVW to 22,000 lb GVW	ASH-1229 ASH-1228 9U94-18045-AA ASH-1205 AT-620 ASH-1022 1C34-18045-AA ASH-294 9U9Z-18124-A ASH-25822 ASH-25823 1C34-18045-JA AT-766	83209
		ASH-1206 9U94-18080-AA AT-621 ASH-25824 9U9Z-18125-A ASH-1023 ASH-1230 ASH-137	83122 89406



GEORGETOWN

08-17	MotorHomes with Ford F53 Chassis with 16,000 lb GVW to 22,000 lb GVW	ASH-1229 ASH-1228 9U94-18045-AA ASH-1205 AT-620 ASH-1022 1C34-18045-AA ASH-294 9U9Z-18124-A ASH-25822 ASH-25823 1C34-18045-JA AT-766	83209
		ASH-1206 9U94-18080-AA AT-621 ASH-25824 9U9Z-18125-A ASH-1023 ASH-1230 ASH-137	83122 89406

GEORGETOWN GT3

16-24	MotorHomes with Ford F53 Chassis with 16,000 lb GVW to 22,000 lb GVW	ASH-1229 ASH-1228 9U94-18045-AA ASH-1205 AT-620 ASH-1022 1C34-18045-AA ASH-294 9U9Z-18124-A ASH-25822 ASH-25823 1C34-18045-JA AT-766	83209
		ASH-1206 9U94-18080-AA AT-621 ASH-25824 9U9Z-18125-A ASH-1023 ASH-1230 ASH-137	83122 89406

APPLICATION GUIDE

Year	Fitment Notes	OEM#								
			Fleetline\ Gas SLX	Classic\ Ultra\ ProGuard\ Guardian	Max Control\ LTV Severe Duty\ Load Carrier\ HiJackers\ OffGrid Nomads	Steering Dampers\ Steering Stabilizer\ Cab Shock	Fleetline\ Gas SLX	Classic\ Ultra\ ProGuard\ Guardian	Max Control\ LTV Severe Duty\ Load Carrier\ HiJackers\ OffGrid Nomads	Steering Dampers\ Steering Stabilizer\ Cab Shock

FOREST RIVER

FOREST RIVER

GEORGETOWN GT5

17-24	MotorHomes with Ford F53 Chassis with 16,000 lb GVW to 22,000 lb GVW	ASH-1229 ASH-1228 9U94-18045-AA ASH-1205 AT-620 ASH-1022 1C34-18045-AA ASH-294 9U9Z-18124-A ASH-25822 ASH-25823 1C34-18045-JA AT-766	OO	83209
		ASH-1206 9U94-18080-AA AT-621 ASH-25824 9U9Z-18125-A ASH-1023 ASH-1230 ASH-137	OO	83122 89406

GEORGETOWN GT7

20-24	MotorHomes with Ford F53 Chassis with 16,000 lb GVW to 22,000 lb GVW	ASH-1229 ASH-1228 9U94-18045-AA ASH-1205 AT-620 ASH-1022 1C34-18045-AA ASH-294 9U9Z-18124-A ASH-25822 ASH-25823 1C34-18045-JA AT-766	OO	83209	
		ASH-1206 9U94-18080-AA AT-621 ASH-25824 9U9Z-18125-A ASH-1023 ASH-1230 ASH-137	OO	83122 89406
		MotorHomes with Ford F53 Chassis with 24,000 lb GVW to 26,000 lb GVW	ASH-25821 ASH-1161	OO	85006
		ASH-25820 ASH-1162	OO	OO	85005 89430	



LEXINGTON

03-15	MotorHomes with Ford E350 or E450 Chassis	8C2Z-18124-D 8C24-18045-DA ASH-1154 AT-163G	OO	G63622	58622 77614
		8C24-18080-DB ASH-1136 8C2Z-18125-D AT-164G	OO	OO	G63623	58623 77623

REFLECTION

02-04	MotorHomes with Freightliner XC Chassis & ADL200 Suspension w/ 20K Rear ADL200 Suspension w/ 20K Rear	16-16873-000	OO	OO	85029
		141700131809 16-16736-000	OO	OO	85029
		16-16874-000 16-16737-000 141700131810	OO	83160
		16-18103-000 481700000493	OO	85900

APPLICATION GUIDE

Year	Fitment Notes	OEM#								
			Fleetline\ Gas SLX	Classic\ Ultra\ ProGuard\ Guardian	Max Control\ LTV Severe Duty\ Load Carrier\ Hijackers\ OffGrid Nomads	Steering Dampers\ Steering Stabilizer\ Cab Shock	Fleetline\ Gas SLX	Classic\ Ultra\ ProGuard\ Guardian	Max Control\ LTV Severe Duty\ Load Carrier\ Hijackers\ OffGrid Nomads	Steering Dampers\ Steering Stabilizer\ Cab Shock

FOREST RIVER

FOREST RIVER

SOLERA

21-24	MotorHomes with Ford E350 or E450 Chassis	8C2Z-18124-D 8C24-18045-DA ASH-1154 AT-163G			G63622	58622 77614				
		8C24-18080-DB ASH-1136 8C2Z-18125-D AT-164G							G63623	58623 77623
10-15	MotorHomes with Ford E350 or E450 Chassis	8C2Z-18124-D 8C24-18045-DA ASH-1154 AT-163G			G63622	58622 77614				
		8C24-18080-DB ASH-1136 8C2Z-18125-D AT-164G							G63623	58623 77623

SUNSEEKER

23	MotorHomes with Ford E350 or E450 Chassis	8C2Z-18124-D 8C24-18045-DA ASH-1154 AT-163G			G63622	58622 77614				
		8C24-18080-DB ASH-1136 8C2Z-18125-D AT-164G							G63623	58623 77623
07-22	MotorHomes with Ford E350 or E450 Chassis	8C2Z-18124-D 8C24-18045-DA ASH-1154 AT-163G			G63622	58622 77614				
		8C24-18080-DB ASH-1136 8C2Z-18125-D AT-164G							G63623	58623 77623
99-06	MotorHomes with Ford E350 or E450 Chassis	8C2Z-18124-D 8C24-18045-DA ASH-1154 AT-163G			G63622	58622 77614				
		8C24-18080-DB ASH-1136 8C2Z-18125-D AT-164G							G63623	58623 77623

SUNSEEKER GTS

19-20	MotorHomes with Ford E350 or E450 Chassis	8C2Z-18124-D 8C24-18045-DA ASH-1154 AT-163G			G63622	58622 77614				
		8C24-18080-DB ASH-1136 8C2Z-18125-D AT-164G							G63623	58623 77623
15-18	MotorHomes with Ford E350 or E450 Chassis	8C2Z-18124-D 8C24-18045-DA ASH-1154 AT-163G			G63622	58622 77614				
		8C24-18080-DB ASH-1136 8C2Z-18125-D AT-164G							G63623	58623 77623



SUNSEEKER TS

17-22	MotorHomes with Ford Transit-350 Chassis				G57816 ⁴⁰					
-------	--	--	--	--	----------------------	--	--	--	--	--

TSUNAMI

02-06	MotorHomes with Freightliner XC Chassis & ADL200 Suspension w/ 20K Rear ADL200 Suspension w/ 20K Rear	16-16873-000								
-------	---	--------------	--	--	--	--	--	--	--	--

APPLICATION GUIDE

Year	Fitment Notes	OEM#								
			Fleetline\ Gas SLX	Classic\ Ultra\ ProGuard\ Guardian	Max Control\ LTV Severe Duty\ Load Carrier\ HiJackers\ OffGrid Nomads	Steering Dampers\ Steering Stabilizer\ Cab Shock	Fleetline\ Gas SLX	Classic\ Ultra\ ProGuard\ Guardian	Max Control\ LTV Severe Duty\ Load Carrier\ HiJackers\ OffGrid Nomads	Steering Dampers\ Steering Stabilizer\ Cab Shock

FOREST RIVER

FOREST RIVER

TSUNAMI (cont)

02-06	MotorHomes with Freightliner XC Chassis & ADL200 Suspension w/ 20K Rear Rear Shock with O.E.M. Number	141700131809 16-16736-000	O	85029
	MotorHomes with Freightliner XC Chassis and AS120 Front Suspension	16-16874-000 16-16737-000 141700131810	O	83160
	MotorHomes with Freightliner XC ChassisZF & IFS Front Suspension with 23,000 lb GVW or Greater ZF - IFS Front Suspension with 23,000 lb GVW or Greater	16-18103-000 481700000493	I	85900

FREIGHTLINER

FREIGHTLINER

B2

05-23	Models with 12000 lb Taperleaf Front Suspension	10-13634-000 10-13211-000	O	85918
	Models with FAS II (40,000 lb) Rear Air Suspension	16-15817-000 16-13957-000 16-18708-000 481700006848 471700002809 SDA471700002809	O	85724 89443
05-22	Models with 15,000 lb Rear Suspension	6803260000	O	83120

BUS CHASSIS

	FB Shuttle bus chassis with O.E.M. Number	16-16765-000 471700131775	O	85006
	School Bus Chassis with 7,000 lb Suspension	471700005079 10-13859-000	O	85005
	Shuttle Bus Chassis	16-16082-000	O	85043
97-08	F65 School bus chassis with 10,000 to 18,000 lb Suspension	6803230300 471700003009 10-13759-000 GBL665538	O	85006
	F65 School bus chassis with Taperleaf Spring	6803260000 GBL654725	O	83120



FL50

95-05	Day Cab Suspensions with O.E.M. Number	18-32999-001 18-60295-000 18-30378-000	O	83006
	Models with 10,000 to 18,000 lb Suspension	6803230300 471700003009 10-13759-000 GBL665538	O	85006
	Models with 15,000 lb Rear Suspension	6803260000 GBL654725	O	83120
	Models with 6000 to 9000 lb Front axle	6803230200	O	85043
	Models with FAS II (40,000 lb) Rear Air Suspension	16-15817-000 16-13957-000	O	85724 89443

FL60

96-05	Day Cab Suspensions with O.E.M. Number	18-32999-001 18-60295-000 18-30378-000	O	83006
91-05	Models with 10,000 to 18,000 lb Suspension	6803230300 471700003009 10-13759-000 GBL665538	O	85006
	Models with 6000 to 9000 lb Front axle	6803230200	O	85043
	Models with FAS II (40,000 lb) Rear Air Suspension	16-15817-000 16-13957-000	O	85724 89443
	Trucks with Link Cabmate Models FRT153BC-A , FRT106BC or FRT106HD-A	1201-0054 1202-0054	O	83021

APPLICATION GUIDE

Year	Fitment Notes	OEM#								
			Fleetline\ Gas SLX	Classic\ Ultra\ ProGuard\ Guardian	Max Control\ LTV Severe Duty\ Load Carrier\ Hijackers\ OffGrid Nomads	Steering Dampers\ Steering Stabilizer\ Cab Shock	Fleetline\ Gas SLX	Classic\ Ultra\ ProGuard\ Guardian	Max Control\ LTV Severe Duty\ Load Carrier\ Hijackers\ OffGrid Nomads	Steering Dampers\ Steering Stabilizer\ Cab Shock

FREIGHTLINER

FL60 (cont)

FREIGHTLINER

91-05	w/ 15000 lb Rear Suspension	6803260000 GBL654725	01	83120
-------	-----------------------------	-------------------------	------	------	------	------	----	-------	------	------	------

M2

	Models O.E.M. Number	10-13592-000 47170000440	00	85959
05-21	Models with FAS II (40,000 lb) Rear Air Suspension	16-15817-000 16-18708-000 481700006848 471700002809 SDA471700002809	00	85724 89443
	Models with Freightliner TufTrac Rear Air Suspension	481700125969 16-15770-000	00	85956
	Models with Hendrickson HMX 400/460 Haulmax with 16.5" Saddle	60680-004L 60680-004 H60680-004	10	83143
	Models with Hendrickson HMX 400/460 Haulmax with 17.5" & 18.5" Saddle	60680-005L HDR60680-005 60680-005	10	83142
	Models with Rear 10000 lb - 15000 lb Low Profile AirLiner	16-18711-000 16-16577-000 471700002996	00	85335
	Models with Rear 52" Spring ,10000 lb - 15000 lb	16-16486-000 16-18710-000 471700002995	01	83134
	Models with Rear 52" Spring ,18000 lb - 23000 lb	471700002994 16-16442-000 16-18709-000	01	83134
	Models with Rear 60" Spring ,18000 lb - 23000 lb	16-15765-000 471700002993 16-18707-000	01	85921
05-15	Models with Freightliner Low Profile Rear Air Suspension (18,000 to 40,000 lb)	16-14259-000 471700002992 16-18706-000	00	85331



M2 100

02-10	Models with FAS II (40,000 lb) Rear Air Suspension	16-15817-000 16-18708-000 481700006848 471700002809 SDA471700002809	00	85724 89443
	Models with Freightliner Low Profile Rear Air Suspension (18,000 to 40,000 lb)	16-14259-000 471700002992 16-18706-000	00	85331
	Models with Freightliner TufTrac Rear Air Suspension	481700125969 16-15770-000	00	85956
	Models with Hendrickson HMX 400/460 Haulmax with 16.5" Saddle	60680-004L 60680-004 H60680-004	10	83143
	Models with Hendrickson HMX 400/460 Haulmax with 17.5" & 18.5" Saddle	60680-005L HDR60680-005 60680-005	10	83142
	Models with Rear 10000 lb - 15000 lb Low Profile AirLiner	16-18711-000 16-16577-000 471700002996	00	85335
	Models with Rear 52" Spring ,10000 lb - 15000 lb	16-16486-000 16-18710-000 471700002995	01	83134
	Models with Rear 52" Spring ,18000 lb - 23000 lb	471700002994 16-16442-000 16-18709-000	01	83134
Models with Rear 60" Spring ,18000 lb - 23000 lb	16-15765-000 471700002993 16-18707-000	01	85921	

M2 106

24-25	Models with Rear 52" Spring ,18000 lb - 23000 lb	16-16486-000 471700002994 16-18710-000 16-16442-000 16-18709-000	01	83134
-------	--	--	------	------	------	------	----	-------	------	------	------

APPLICATION GUIDE

Year	Fitment Notes	OEM#								
			Fleetline/ Gas SLX	Classic/ Ultra/ ProGuard/ Guardian	Max Control/ LTV Severe Duty/ Load Carrier/ HiJackers/ OffGrid Nomads	Steering Dampers/ Steering Stabilizer/ Cab Shock	Fleetline/ Gas SLX	Classic/ Ultra/ ProGuard/ Guardian	Max Control/ LTV Severe Duty/ Load Carrier/ HiJackers/ OffGrid Nomads	Steering Dampers/ Steering Stabilizer/ Cab Shock

FREIGHTLINER

FREIGHTLINER

M2 106 (cont)

09-25	Models with 8000 to 16000 lb Front Axle and Taperleaf Spring	10-13760-000 10-13592-000 47170000440 471700002991 SDA471700002991	OO	85959
02-25	Models with Freightliner TufTrac Rear Air Suspension	481700125969 16-15770-000	OO	OO	85956
	Models with Hendrickson HMX 400/460 Haulmax with 16.5" Saddle	60680-004L 60680-004 H60680-004	OO	OO	83143
	Models with Hendrickson HMX 400/460 Haulmax with 17.5" & 18.5" Saddle	60680-005L HDR60680-005 60680-005	OO	OO	83142
	Models with Rear 52" Spring ,10000 lb - 15000 lb, 18,000-23,000 lb Springs	16-16486-000 16-18710-000 16-16442-000 16-18709-000	OO	OO	83134
25	Models with FAS II (40,000 lb) Rear Air Suspension	16-15817-000 16-13957-000 16-18708-000	OO	OO	85724
02-24	Day Cab Models with Spring Suspensions	18-47350-000 18-60766-000 814903003482	OO	83040
	Models with FAS II (40,000 lb) Rear Air Suspension	16-15817-000 16-18708-000 481700006848 471700002809 SDA471700002809	OO	OO	85724 89443
02-23	Models with Rear 10000 lb - 15000 lb Low Profile AirLiner	16-18711-000 16-16577-000 471700002996	OO	OO	85335
	Models with Rear 52" Spring ,10000 lb - 15000 lb	16-16486-000 16-18710-000 471700002995	OO	OO	83134
	Models with Rear 52" Spring ,18000 lb - 23000 lb	471700002994 16-16442-000 16-18709-000	OO	OO	83134
	Models with Rear 60" Spring ,18000 lb - 23000 lb	16-15765-000 471700002993 16-18707-000	OO	OO	85921
	Models with Reyco 79KB Rear Steel Spring Suspension	19495-01 16725-01	OO	OO	83126 89430
02-15	Models with Freightliner Low Profile Rear Air Suspension (18,000 to 40,000 lb)	16-14259-000 471700002992 16-18706-000	OO	OO	85331
02-08	Models with 10000 to 12000 lb. Taper-leaf Spring Suspension	10-12390-000	OO	85920
	Models with 6000 to 9000 lb Front axle	10-12388-000	OO	85920

MB CHASSIS

	MB Chassis (VIP bus)	16-17760-000 471700131778 16-16827-000	OO	OO	85331
	MB55 Chassis	16-17759-000 471700000447	OO	OO	85919
	MB55 Models w/8000 lb. flat leaf front suspension	16-17684-000	OO	85058
	MB55 Shuttle bus w/8000 lb. flat leaf front suspension	16-15676-000	OO	85058



MP 14

	MP 14 Chassis	16-15475-000	OO	83164
--	---------------	--------------	----	-------	------	------	------	------	------	------	------	------

MP 19

	MP 19 Chassis	16-15475-000	OO	83164
--	---------------	--------------	----	-------	------	------	------	------	------	------	------	------

APPLICATION GUIDE

Year	Fitment Notes	OEM#								
			Fleetline\ Gas SLX	Classic\ Ultra\ ProGuard\ Guardian	Max Control\ LTV Severe Duty\ Load Carrier\ Hijackers\ OffGrid Nomads	Steering Dampers\ Steering Stabilizer\ Cab Shock	Fleetline\ Gas SLX	Classic\ Ultra\ ProGuard\ Guardian	Max Control\ LTV Severe Duty\ Load Carrier\ Hijackers\ OffGrid Nomads	Steering Dampers\ Steering Stabilizer\ Cab Shock

FREIGHTLINER

FREIGHTLINER

MT45

98-23	Step Van Models with O.E.M. Number	16-20628-000 471700003011 16-22004-000 471700011302 16-19138-000	010	85058
	Walkin Step Van Models (18 Foot) with O.E.M. Number	16-20552-000 16-16542-000 16-15064-000 471700010991 16-15436-000	010	83154
99-20	MT45 Step Van - w/35" Front Spring	16-15473-000 16-15474-000	010	83157
	MT45 Step Van - w/38" Front Spring	16-15475-000	010	83164
98-20	Models with O.E.M. Number	16-15394-000	010	83120

MT55

	MT55 Models w/8000 lb. flat leaf front suspension	16-17684-000 16-15676-000	010	85058
	MT55 Step Van with O.E.M. Number To 2020	16-16542-000 16-15436-000	010	83154
99-24	Models with Freightliner Low Profile Rear Air Suspension	16-18706-000	010	85331
	MT55 Chassis with O.E.M. Number	16-17759-000 471700000447 16-20632-000	010	85919
99-20	MT55 Step Van - w/35" Front Spring	16-15473-000 16-15474-000	010	83157
	MT55 Step Van - w/38" Front Spring	16-15475-000	010	83164
99-11	Models with O.E.M. Number	16-16262-000 16-15934-000 16-15705-000	010	83120

VARIOUS

	Fleetwood Motor Home with O.E.M. Number	GBL 651375 RW24285	010	83119
	M-Line Walk in Van with O.E.M. Number	P117099 MAE 16949	010	83120
	Models with 7000 lb Front Suspension	10-13776-000	010	85005
	Models with Neway Air Suspension with shock stamping	90045083	010	85910
	Oshkosh Motor Home with O.E.M. Number	1398980	010	83127
	Step Van Models with O.E.M. Number	471700003011 16-19138-000	010	85058
18-24	Models with Freightliner S2RV chassis	10-13976-000	010	85918
		16-16764-000	010	85724 89443

VC CHASSIS

03-12	VC Chassis - ADL200 Suspension w/ 23,000 lb GVW & Higher	141700131809 16-16736-000	010	85029
03-07	MotorHome Chassis with ZF - IFS Front Suspension (23,000 lb GVW & Higher)	16-18103-000 481700000493	010	85900
	VC Chassis - ADL200 Suspension w/ 20K Rear	16-16873-000 471700131974	010	85029
93-07	VC Chassis - Neway AS-120 Front Air Suspension (Up To 22000 lb GVW)	16-16737-000	010	83160

XB CHASSIS

	MotorHome Chassis with Neway AS-120, 10,500 lb Front Air Suspension	141700000377 16-18075-000	010	83160
--	---	------------------------------	-----	-------	-----	-----	-----	-----	-----	-----	-----	-----

APPLICATION GUIDE

Year	Fitment Notes	OEM#								
			Fleetline/ Gas SLX	Classic/ Ultra/ ProGuard/ Guardian	Max Control/ LTV Severe Duty/ Load Carrier/ HiJackers/ OffGrid Nomads	Steering Dampers/ Steering Stabilizer/ Cab Shock	Fleetline/ Gas SLX	Classic/ Ultra/ ProGuard/ Guardian	Max Control/ LTV Severe Duty/ Load Carrier/ HiJackers/ OffGrid Nomads	Steering Dampers/ Steering Stabilizer/ Cab Shock

FREIGHTLINER

FREIGHTLINER

XB CHASSIS (cont)

MotorHome Chassis with Neway AS-120, 12,000 lb Front Air Suspension	16-16874-000 141700000378 16-18076-000 141700131975	OO	83160
---	--	----	-------	------	------	------	------	------	------	------

XC CHASSIS

MotorHome Chassis with Neway AS-120, 10,500 lb Front Air Suspension	141700000377 16-18075-000	OO	83160
MotorHome Chassis with Neway AS-120, 12,000 lb Front Air Suspension	16-16874-000 141700000378 16-18076-000 141700131975	OO	83160
MotorHome Chassis with ZF- IFS, 12,000 lb Front Air Suspension	16-17144-000 481700000477 481700131919 16-17361-000	IT	85900
03-12 MotorHome Chassis with Neway AS-120 Front Air Suspension (23,000 lb GVW & Higher)	16-16874-000 16-16737-000 141700131810	OO	83160
	XC Chassis - ADL200 Suspension w/ 23,000 lb GVW & Higher	141700131809 16-16736-000	OO	85029
03-07 MotorHome Chassis with ZF - IFS Front Suspension (23,000 lb GVW & Higher)	16-18103-000 481700000493	IT	85900
	XC Chassis - ADL200 Suspension w/ 20K Rear	16-16873-000 471700131974	OO	85029
93-07 MotorHome Chassis with Neway AS-120 Front Air Suspension (Up To 22000 lb GVW)	16-16737-000	OO	83160

XCS CHASSIS

01-02 XCS Chassis with Freightliner Rear Air Suspension	16-16093-000	OO	83160
00-02 XCS Chassis (22000 lb GVW) w/ O.E.M. Number	16-15755-000 16-16043-000	OO	85043
	16-15592-000	IT	83154

GEORGIE BOY MANUFACTURING

GEORGIE BOY MANUFACTURING



CLASS A MOTORHOMES

Models with Workhorse UFO Chassis with Hendrickson Softek Front Suspension	66153-002 F4-BE5-C832-MO	OO	83124
99-09 All Series MotorHomes with Ford F53 Chassis with 16,000 lb GVW to 22,000 lb GVW	ASH-1229 ASH-1228 9U94-18045-AA ASH-1205 AT-620 ASH-1022 1C34-18045-AA ASH-294 9U9Z-18124-A ASH-25822 ASH-25823 1C34-18045-JA AT-766	OO	83209
	ASH-1206 9U94-18080-AA AT-621 ASH-25824 9U9Z-18125-A ASH-1023 ASH-1230 ASH-137	OO	83122 89406

CLASS C MOTORHOMES

99-09 Maverick Series MotorHomes with Ford E450 Chassis	ASH-1154	IO	G63622	58622 77614
	ASH-1136	IO	G63623	58623 77623

APPLICATION GUIDE

Year	Fitment Notes	OEM#								
			Fleetline\ Gas SLX	Classic\ Ultra\ ProGuard\ Guardian	Max Control\ LTV Severe Duty\ Load Carrier\ Hijackers\ OffGrid Nomads	Steering Dampers\ Steering Stabilizer\ Cab Shock	Fleetline\ Gas SLX	Classic\ Ultra\ ProGuard\ Guardian	Max Control\ LTV Severe Duty\ Load Carrier\ Hijackers\ OffGrid Nomads	Steering Dampers\ Steering Stabilizer\ Cab Shock

GLAVAL BUS CO.

GLAVAL BUS CO.

CONCORDE II - SERIES

15-23	Models with F-650 chassis with 13,500, 15,500 & 19,000 lb Multi-leaf Rear Springs From 07/15	FC4Z-18125-A ASH-24660 471700011531 FC44-18080-AB	00	85180	00	00	00	00	00	00	00	00	00
	Models with F-650 chassis with 19.5" or 22.5" Wheels (22,000 lb GVW) From 07/15	FC4Z-18124-B FC4Z-18124-A ASH-24659 ASH-24658 471700011530 FC44-18045-BB	00	85181	00	00	00	00	00	00	00	00	00
04-15	Models with F-650 chassis with 21,000 lb Rear Air Suspension To 2015	3578858C1 3578858C2 4C4Z-18125-DA	00	85656	00	00	00	00	00	00	00	00	00
	Models with F-650 chassis with 22,000 lb Multi-leaf Rear Springs	4C4Z-18125-B 501906C92 ASH-24661	00	83317	00	00	00	00	00	00	00	00	00
00-15	Models with F-650 chassis with 10,000 lb Front Suspension	3584116C1 3584116C2 AA-616 4C4Z-18124-QA	00	83175	00	00	00	00	00	00	00	00	00
	Models with F-650 chassis with 12,000 & 13,200 lb Front Springs	4C4Z-18124-JB 3584118C2 AA-617 4C4Z-18124-RA AT-812	00	85928	00	00	00	00	00	00	00	00	00

VARIOUS

	Primetime Series Shuttle buses with Ford E350 Chassis To 2020	ASH-1136	00	G63623	00	00	00	00	00	00	00	00	00
	Primetime Series Shuttle buses with Ford E350 Chassis To 2022	ASH-1154	00	G63622	00	00	00	00	00	00	00	00	00
	Sport Series Shuttle buses with Ford E350 Chassis To 2020	ASH-1136	00	G63623	00	00	00	00	00	00	00	00	00
	Sport Series Shuttle buses with Ford E350 Chassis To 2022	ASH-1154	00	G63622	00	00	00	00	00	00	00	00	00
	Universal Series Shuttle buses with Ford E350 & E450 Chassis To 2020	ASH-1136	00	G63623	00	00	00	00	00	00	00	00	00
	Universal Series Shuttle buses with Ford E350 & E450 Chassis To 2022	ASH-1154	00	G63622	00	00	00	00	00	00	00	00	00

GMC

GMC



3500 & 4000 SERIES

63-66	Truck and School Bus	00	85005	00	00	00	00	00	00	00	00	00	00
60-62	3500, 4000, B-4000, L-4000, S-4000 with H-130, H-150 and 13800 Axles	00	83221	00	00	00	00	00	00	00	00	00	00

4500 SERIES

72-80	PS4620 P, 4650P Step Van (Walk-in)	22012096 3192892	00	83221	00	00	00	00	00	00	00	00	00
	PS4620 P, 4650P Step Van (Walk-in) 3/4" Upper bolt	4940606 22012166 4975497 22007701 22002293 3192890 22012095	00	83126	00	00	00	00	00	00	00	00	00
	PS4620 P, 4650P Step Van (Walk-in) 5/8" Upper bolt	22007751	00	83303	00	00	00	00	00	00	00	00	00
66-72	CE-4500, CS-4500 Conventional Cab with V-8 Gas or In-line 6 Gas Engines	22012096 3192892	00	83221	00	00	00	00	00	00	00	00	00
	EG-4500, EM-4500, ES-4500 Cab/Cowl with V-6 Gas or Diesel or In-line 6 Gas Engines	3171068 4940614 3192657 4963854 4963853	00	83216	00	00	00	00	00	00	00	00	00

APPLICATION GUIDE

Year	Fitment Notes	OEM#								
			Fleetline\ Gas SLX	Classic\ Ultra\ ProGuard\ Guardian	Max Control\ LTV Severe Duty\ Load Carrier\ HiJackers\ OffGrid Nomads	Steering Dampers\ Steering Stabilizer\ Cab Shock	Fleetline\ Gas SLX	Classic\ Ultra\ ProGuard\ Guardian	Max Control\ LTV Severe Duty\ Load Carrier\ HiJackers\ OffGrid Nomads	Steering Dampers\ Steering Stabilizer\ Cab Shock

GMC

GMC

4500 SERIES (cont)

66-72	EG-4500, EM-4500, ES-4500 Cab/Cowl with V-6 Gas or Diesel or In-line 6 Gas Engines	3171462 3192890 22012095				O/O 83126 89430
-------	--	--------------------------------	--	------	------	------	------	--	--	-----------------------	------	------	------

5000 SERIES

76-89	C Chassis - Conventional Cab	22012096 22012196				O/O 83221
75-80	C Chassis - Conventional Cab	4975510	O/O	83221
73-80	C, S Chassis - Conventional Cab	22007750 4975494 4975467	O/O	83207
63-68	W-5000, BW-5000, DW-5000	O/O	85005
60-62	5000, B-5000, L-5000, S-5000 with 1618 or 16802 Axle	O/O			83221

5500 SERIES

73-89	C, S Chassis - Conventional Cab and School Bus	22012166 22012095		O/O 83126
66-72	CE-5500, CS-5500 Conventional Cab with V-8 Gas or In-line 6 Gas Engines	22012096 3192892 3192891	O/O	83221
	CG-5500, CM-5500, T-5500 Conventional & Tilt Cab with V-6 Gas or Diesel Engines	4940606 3192890 22012095	O/O	83126
	EG-5500, EM-5500, ES-5500 Cab/Cowl with 6 Cyl. Engines	3171068 4940614 3192657 4963854 4963853		O/O	83216
		3171462 3192890 22012095		O/O			83126 89430
63-68	W-5500	O/O	85005
60-68	LW-5500	O/O	85307



6000 SERIES

79-80	W Chassis - 72" BBC Steel Tilt Cab	22002293		O/O 83126
		22007751	O/O	83303
73-75	C, S Chassis - Conventional Cab and School Bus - Exc. with 18500, 20800 & 23000 lb. Rear Axle	22007750 4975494 4975467	O/O	83207
63-68	DW - 6000	O/O	85005
60-68	L - 6000	O/O	85307

6500 SERIES

75-89	C, M Chassis - Conventional Cab with 9000 & 12000 lb. Axle	22007751 22002295 22017531 4975511 22017530		O/O 83303
73-80	C, M, S Chassis - Conventional Cab and School Bus - Exc. with 20800 or 23000 lb. Rear Axle	22012169 22012096 3192892		O/O			83221
	C, M, S Chassis - Conventional Cab and School Bus with 20800 or 23000 lb. Rear Axle	4940606 22012166 22012095		O/O			83126 89430
	C, S, T Chassis - Conventional & Tilt Cab and School Bus	4940606 4975497 22002293 3192890 22012095		O/O	83126
75-76	C, M Chassis - Conventional Cab	4975510	O/O	83221

APPLICATION GUIDE

Year	Fitment Notes	OEM#								
			Fleetline\ Gas SLX	Classic\ Ultra\ ProGuard\ Guardian	Max Control\ LTV Severe Duty\ Load Carrier\ Hijackers\ OffGrid Nomads	Steering Dampers\ Steering Stabilizer\ Cab Shock	Fleetline\ Gas SLX	Classic\ Ultra\ ProGuard\ Guardian	Max Control\ LTV Severe Duty\ Load Carrier\ Hijackers\ OffGrid Nomads	Steering Dampers\ Steering Stabilizer\ Cab Shock

GMC

GMC

6500 SERIES (cont)

73-75	C, M Chassis - Conventional Cab with 9000 & 12000 lb. Axle	4940606 4975497 3192890 22012095	OO	83126	
		4940614 4963854	OO	83216	
		C, M, S Chassis - Conventional Cab and School Bus	22007750 4975494 4975467	OO	83207
		66-72	CE-6500, CM-6500 Conventional Cab with V-6 Diesel or V-8 Gas Engine	3192892	OO	83221
	CE-6500, ME-6500 Conventional Cab with V-8 Gas Engine - Exc. 11000 lb. Axle	22012096 3192892 3192891	OO	83221	
	CE-6500, ME-6500 Conventional Cab with V-8 Gas Engine with 11000 lb. Axle	4940606 3192890 22012095	OO	83126	
	CM-6500, TE-6500, TM-6500 Conventional Cab with V-6 Diesel or V-8 Gas Engine	4940606 3192890 22012095	OO	83126	
	EG-6500, DM-6500, ES-6500 Cab/Cowl with V-6 Gas or Diesel or In-line 6 Gas Engines	3171068 3192657 4963853	OO	83216	
		3171462 3192890 22012095	OO	83126 89430	

C - SERIES (C4500, C5500) TOPKICK

90-99	C Chassis - Conventional Cab with 9100 to 17500 lb Rear Axle	22064432	OO	83221
83-89	C Chassis - Conventional Cab with 9100 to 17500 lb. Rear Axle	22064432	OO	83221



C - SERIES (C6500, C7500, C8500) TOPKICK

90-09	Conventional Cab Front Shock with O.E.M. Number	88982682 15588554 15887728 15174898 19152843 22064230 15123676	I	83136
	Conventional Cab w/19000, 21000, 23000 lb Taperleaf Springs (EXC Low Profile Vehicle)	22064233	I	83136
	Conventional Cab With 15000, 19000, 21000 lb Multileaf Springs	15174902 88982686 22064232	I	85071
95-02	Models with Hendrickson Air Suspension (Stamping number 47902-13)	12474915 15963161	OO	83122 89406
90-99	Conventional Cab with 9100 to 17500 lb Rear Axle	22064432	OO	83221
83-89	Conventional Cab with 9100 to 17500 lb. Rear Axle	22064432	OO	83221

C4500 TOPKICK

03-09	C Chassis - Conventional Cab with 15000, 19000, 21000 lb Multileaf Springs	15174902 88982686 22064232	I	85071
	C Chassis - Conventional Cab with 19000, 21000, 23000 lb Taperleaf Springs (EXC Low Profile Vehicle)	22064233	I	83136
	C Chassis - Conventional Cab with Front Shock with O.E.M. Number	88982682 15588554 15887728 19152843 22064230 15123676	I	83136

APPLICATION GUIDE

Year	Fitment Notes	OEM#								
			Fleetline/ Gas SLX	Classic/ Ultra/ ProGuard/ Guardian	Max Control/ LTV Severe Duty/ Load Carrier/ HiJackers/ OffGrid Nomads	Steering Dampers/ Steering Stabilizer/ Cab Shock	Fleetline/ Gas SLX	Classic/ Ultra/ ProGuard/ Guardian	Max Control/ LTV Severe Duty/ Load Carrier/ HiJackers/ OffGrid Nomads	Steering Dampers/ Steering Stabilizer/ Cab Shock

GMC

GMC

C4500 TOPKICK (cont)

03-09	Models with Link Cabmate Model GMT560	1201-1043 1202-1043	O O	83025
	Truck Cabs with Link Cabmate Model GMC104TK	1201-0054 1202-0054	O O	83021
90-02	C Chassis - Conventional Cab with 15000, 19000, 21000 lb Multileaf Springs	15174902 88982686 22064232	I T	85071
	C Chassis - Conventional Cab with 19000, 21000, 23000 lb Taperleaf Springs (EXC Low Profile Vehicle)	22064233	I T	83136
	C Chassis - Conventional Cab with Front Shock with O.E.M. Number	88982682 15588554 15887728 19152843 22064230 15123676	I T	83136

C5500 TOPKICK

03-09	C Chassis - Conventional Cab with 15000, 19000, 21000 lb Multileaf Springs	15174902 88982686 22064232	I T	85071
	C Chassis - Conventional Cab with 19000, 21000, 23000 lb Taperleaf Springs (EXC Low Profile Vehicle)	22064233	I T	83136
	C Chassis - Conventional Cab with Front Shock with O.E.M. Number	88982682 15588554 15887728 19152843 22064230 15123676	I T	83136
	Models with Link Cabmate Model GMT560	1201-1043 1202-1043	O O	83025
	Truck Cabs with Link Cabmate Model GMC104TK	1201-0054 1202-0054	O O	83021
90-02	C Chassis - Conventional Cab with 15000, 19000, 21000 lb Multileaf Springs	15174902 88982686 22064232	I T	85071
	C Chassis - Conventional Cab with 19000, 21000, 23000 lb Taperleaf Springs (EXC Low Profile Vehicle)	22064233	I T	83136
	C Chassis - Conventional Cab with Front Shock with O.E.M. Number	88982682 15588554 15887728 19152843 22064230 15123676	I T	83136

C6000 TOPKICK

90-96	Truck Cabs with Link Cabmate Model GMC104TK	1201-0054 1202-0054	O O	83021
-------	---	------------------------	--------	------	------	------	-------	------	------	------	------

C6500 TOPKICK

03-09	Truck Cabs with Link Cabmate Model GMC104TK	1201-0054 1202-0054	O O	83021
97-01	Truck Cabs with Link Cabmate Model GMC104TK	1201-0054 1202-0054	O O	83021

P - SERIES

92-96	Motorhome Chassis	22064233	I T	83136
-------	-------------------	----------	--------	------	------	------	------	-------	------	------	------



SAVANA 4500

10-20	All		I E	61685 G63895	NM1016	O O	61687 G63897	77638 NM1015
-------	-----	--	--------	------	-----------------	--------	------	--------	------	-----------------	-----------------	------

T5500

97-09	FL1 Tilt Cab with 8100 lb Axle	22165188 22165187 22064804 22064805	I T	83136
-------	--------------------------------	--	--------	-------	------	------	------	------	------	------	------	------

APPLICATION GUIDE

Year	Fitment Notes	OEM#								
			Fleetline/ Gas SLX	Classic/ Ultra/ ProGuard/ Guardian	Max Control/ LTV Severe Duty/ Load Carrier/ HiJackers/ OffGrid Nomads	Steering Dampers/ Steering Stabilizer/ Cab Shock	Fleetline/ Gas SLX	Classic/ Ultra/ ProGuard/ Guardian	Max Control/ LTV Severe Duty/ Load Carrier/ HiJackers/ OffGrid Nomads	Steering Dampers/ Steering Stabilizer/ Cab Shock

GMC

GMC

T5500 (cont)

97-09	FL2 Tilt Cab with 5000 to 11000 lb Axle	22166442 22064807		83136
	FL3 Tilt Cab with 14575 lb Axle	22165189 22064806		83136
90-06	Tilt Cab with 15000, 19000, 21000 lb Multileaf Springs	15174902 22064232			85071
92-99	Tilt Cab with 19000, 21000, 23000 lb Taperleaf Springs (EXC Low Profile Veh.)	22064233			83136
99	Models with Hendrickson Air Suspension (Stamping number 47902-13)	12474915 15963161			83122 89406



T6500

06-09	15,000lb; 17,000lb; 19,000lb; 21,000lb and 23,000lb Axle	88982687			85705
04-09	FL1 Tilt Cab with 8100 lb Axle	22165188 22165187 22064804 22064805		83136
	FL2 Tilt Cab with 5000 to 11000 lb Axle	22166442 22064807		83136
	FL3 Tilt Cab with 14575 lb Axle	22165189 22064806		83136
04-05	Tilt Cab with 15000, 19000, 21000 lb Multileaf Springs	15174902 22064232			85071
03	FL1 Tilt Cab with 8100 lb Axle	22165188 22165187 22064804 22064805		83136
	FL2 Tilt Cab with 5000 to 11000 lb Axle	22166442 22064807		83136
	FL3 Tilt Cab with 14575 lb Axle	22165189 22064806		83136
	Tilt Cab with 15000, 19000, 21000 lb Multileaf Springs	15174902 22064232			85071
00-02	Low profile, with Axle Code FL1	22165187		83163
	Tilt Cab with 23,000 lb Axles; Tapered Leaf Spring	22064233			83136
	with 16,900lb Axle. Tapered Leaf Springs	22064489			85332
	With Hendrickson Air Suspension	15963161 12474917			85013
97-02	FL1 Tilt Cab with 8100 lb Axle	22165188 22165187 22064804 22064805		83136
	FL2 Tilt Cab with 5000 to 11000 lb Axle	22166442 22064807		83136
	FL3 Tilt Cab with 14575 lb Axle	22165189 22064806		83136
	Tilt Cab with 15000, 19000, 21000 lb Multileaf Springs	15174902 22064232			85071
97-99	Tilt Cab with 19000, 21000, 23000 lb Taperleaf Springs (EXC Low Profile Veh.)	22064233			83136
99	Models with Hendrickson Air Suspension (Stamping number 47902-13)	12474915 15963161			83122 89406
92-96	Tilt Cab with 19000, 21000, 23000 lb Taperleaf Springs (EXC Low Profile Veh.)	22064233			83136
90-96	Tilt Cab with 15000, 19000, 21000 lb Multileaf Springs	15174902 22064232			85071

T7500

06-09	15,000lb; 17,000lb; 19,000lb; 21,000lb and 23,000lb Axle	88982687			85705
-------	--	----------	--	------	------	------	------	--	-------	------	------	------

APPLICATION GUIDE

Year	Fitment Notes	OEM#								
			Fleetline/ Gas SLX	Classic/ Ultra/ ProGuard/ Guardian	Max Control/ LTV Severe Duty/ Load Carrier/ HiJackers/ OffGrid Nomads	Steering Dampers/ Steering Stabilizer/ Cab Shock	Fleetline/ Gas SLX	Classic/ Ultra/ ProGuard/ Guardian	Max Control/ LTV Severe Duty/ Load Carrier/ HiJackers/ OffGrid Nomads	Steering Dampers/ Steering Stabilizer/ Cab Shock

GMC

GMC

T7500 (cont)

04-09	FL1 Tilt Cab with 8100 lb Axle	22165188 22165187 22064804 22064805	I T	83136
	FL2 Tilt Cab with 5000 to 11000 lb Axle	22166442 22064807	I T	83136
	FL3 Tilt Cab with 14575 lb Axle	22165189 22064806	I T	83136
04-05	Tilt Cab with 15000, 19000, 21000 lb Multileaf Springs	15174902 22064232	I T	85071
00-02	Low profile, with Axle Code FL1	22165187	O O	83163
	Tilt Cab with 23,000 lb Axles; Tapered Leaf Spring	22064233	I T	83136
	with 16,900lb Axle. Tapered Leaf Springs	22064489	I O	85332
	With Hendrickson Air Suspension	15963161 12474917	O O	85013
97-02	FL1 Tilt Cab with 8100 lb Axle	22165188 22165187 22064804 22064805	I T	83136
	FL2 Tilt Cab with 5000 to 11000 lb Axle	22166442 22064807	I T	83136
	FL3 Tilt Cab with 14575 lb Axle	22165189 22064806	I T	83136
	Tilt Cab with 15000, 19000, 21000 lb Multileaf Springs	15174902 22064232	I T	85071
97-99	Tilt Cab with 19000, 21000, 23000 lb Taperleaf Springs (EXC Low Profile Veh.)	22064233	I T	83136
99	Models with Hendrickson Air Suspension (Stamping number 47902-13)	12474915 15963161	O O	83122 89406

W - SERIES (ISUZU)

	Models with O.E.M. Number	98098127 98098125 8-97083-029-0 898098-1250 94454987 97253616 8980981270 97201960 97253623 8-97201-960-0 97253621	I O	83515
		98098059 898098-0590 898098-0581 98098058 8-97253665-0 898098-0580 97253665 97253651	O O	83159



W3500 FORWARD

00-08	Models with 11000 lb and 13000 lb suspension	9516306471 94454987 97083027 8972536200 8944549870 8944549860	I O	83515
-------	--	--	--------	-------	------	------	------	------	------	------	------

W4500 FORWARD

00-10	Models with 11000 lb and 13000 lb Suspension	8972536510	O O	83159
-------	--	------------	--------	------	------	------	------	-------	------	------	------

APPLICATION GUIDE

Year	Fitment Notes	OEM#								
			Fleetline\ Gas SLX	Classic\ Ultra\ ProGuard\ Guardian	Max Control\ LTV Severe Duty\ Load Carrier\ HiJackers\ OffGrid Nomads	Steering Dampers\ Steering Stabilizer\ Cab Shock	Fleetline\ Gas SLX	Classic\ Ultra\ ProGuard\ Guardian	Max Control\ LTV Severe Duty\ Load Carrier\ HiJackers\ OffGrid Nomads	Steering Dampers\ Steering Stabilizer\ Cab Shock

GMC

GMC

W4500 FORWARD (cont)

92-10	Models with 11000 lb & 13000 lb Suspension	9516306471 97083029 94454987 98232671 97083027 8972536200 8-94454-986-0 8-94454-987-0 97253620 8-97253-620-0 8944549870 8944549860		83515						
-------	--	---	--	-------	------	------	------	--	--	--	--	--	--

W5500 FORWARD

88-10	Models with 11000 lb & 13000 lb Suspension	97253620		83515						
00-09	Models with 11000 lb and 13000 lb Suspension	8972536510							

W6500 FORWARD

87-96	Models with 11000 lb & 13000 lb Suspension	1-51630-168-1		83515						
-------	--	---------------	--	-------	------	------	------	--	--	--	--	--	--

GOSHEN COACH

GOSHEN COACH

VARIOUS

	Impule Series Shuttle buses with Ford E350 & E450 Chassis To 2020	ASH-1154		G63622	58622 77614						
		ASH-1136							
	Pacer II Series Shuttle buses with Ford E350 Chassis To 2020	ASH-1154		G63622	58622 77614						
		ASH-1136							

GRECH MOTORS

GRECH MOTORS

	Shuttle buses with Ford E450 Chassis To 2020	ASH-1154		G63622	58622 77614						
		ASH-1136							

GULF STREAM

GULF STREAM



ATRIUM

03-06	Models with Freightliner XC Chassis with ZF - IFS Front Suspension and 23,000 lb GVW or Greater	16-18103-000 481700000493		85900						
		16-16874-000 16-16737-000 141700131810		83160						
		16-16873-000 141700131809 16-16736-000							

BT CRUISER

16-24	MotorHomes with Ford E350 or E450 Chassis	8C2Z-18124-D 8C24-18045-DA ASH-1154 AT-163G		G63622	58622 77614						
		8C24-18080-DB ASH-1136 8C2Z-18125-D AT-164G							
02-15	MotorHomes with Ford E350 or E450 Chassis	8C2Z-18124-D 8C24-18045-DA ASH-1154 AT-163G		G63622	58622 77614						

APPLICATION GUIDE

Year	Fitment Notes	OEM#								
			Fleetline\ Gas SLX	Classic\ Ultra\ ProGuard\ Guardian	Max Control\ LTV Severe Duty\ Load Carrier\ HiJackers\ OffGrid Nomads	Steering Dampers\ Steering Stabilizer\ Cab Shock	Fleetline\ Gas SLX	Classic\ Ultra\ ProGuard\ Guardian	Max Control\ LTV Severe Duty\ Load Carrier\ HiJackers\ OffGrid Nomads	Steering Dampers\ Steering Stabilizer\ Cab Shock

GULF STREAM

GULF STREAM

BT CRUISER (cont)

02-15	MotorHomes with Ford E350 or E450 Chassis	8C24-18080-DB ASH-1136 8C2Z-18125-D AT-164G											
-------	---	--	--	--	--	--	--	--	--	--	--	--	--

CAVALIER

99-06	MotorHomes with Ford E350 or E450 Chassis	ASH-1154	I/O		G63622	58622 77614							
		ASH-1136	I/O							G63623	58623 77623		

CONQUEST

16-24	MotorHomes with Ford E350 or E450 Chassis	8C2Z-18124-D 8C24-18045-DA ASH-1154 AT-163G	I/O		G63622	58622 77614							
		8C24-18080-DB ASH-1136 8C2Z-18125-D AT-164G	I/O							G63623	58623 77623		
12-15	MotorHomes with Ford E350 or E450 Chassis	8C2Z-18124-D 8C24-18045-DA ASH-1154 AT-163G	I/O		G63622	58622 77614							
		8C24-18080-DB ASH-1136 8C2Z-18125-D AT-164G	I/O							G63623	58623 77623		
02-11	MotorHomes with Ford E350 or E450 Chassis	8C2Z-18124-D 8C24-18045-DA ASH-1154 AT-163G	I/O		G63622	58622 77614							
		8C24-18080-DB ASH-1136 8C2Z-18125-D AT-164G	I/O							G63623	58623 77623		
93-01	MotorHomes with Ford E350 or E450 Chassis	8C2Z-18124-D 8C24-18045-DA ASH-1154 AT-163G	I/O		G63622	58622 77614							
		8C24-18080-DB ASH-1136 8C2Z-18125-D AT-164G	I/O							G63623	58623 77623		



CONQUEST SPORT

10-11	MotorHomes with Ford E350 or E450 Chassis	8C2Z-18124-D 8C24-18045-DA ASH-1154 AT-163G	I/O		G63622	58622 77614							
		8C24-18080-DB ASH-1136 8C2Z-18125-D AT-164G	I/O							G63623	58623 77623		
01-02	MotorHomes with Ford E350 or E450 Chassis	8C2Z-18124-D 8C24-18045-DA ASH-1154 AT-163G	I/O		G63622	58622 77614							
		8C24-18080-DB ASH-1136 8C2Z-18125-D AT-164G	I/O							G63623	58623 77623		

ENDURA

08	MotorHomes with Chevy Kodiak Chassis	88982682 15588554 15887728 19152843 22064230 15123676	I/T	83136									
----	--------------------------------------	--	-----	-------	--	--	--	--	--	--	--	--	--

APPLICATION GUIDE

Year	Fitment Notes	OEM#								
			Fleetline\ Gas SLX	Classic\ Ultra\ ProGuard\ Guardian	Max Control\ LTV Severe Duty\ Load Carrier\ Hijackers\ OffGrid Nomads	Steering Dampers\ Steering Stabilizer\ Cab Shock	Fleetline\ Gas SLX	Classic\ Ultra\ ProGuard\ Guardian	Max Control\ LTV Severe Duty\ Load Carrier\ Hijackers\ OffGrid Nomads	Steering Dampers\ Steering Stabilizer\ Cab Shock

GULF STREAM

GULF STREAM

ENDURA (cont)

04-07	MotorHomes with Chevy Kodiak Chassis	88982682 15588554 15887728 19152843 22064230 15123676		83136						
-------	--------------------------------------	--	--	-------	------	------	------	--	--	--	--	--	--

FRIENDSHIP

02-06	Models with Freightliner XC Chassis with ZF - IFS Front Suspension and 23,000 lb GVW or Greater	16-18103-000 481700000493		85900						
	MotorHomes with Freightliner XC Chassis & AS120 Front Suspension AS120 Front Suspension	16-16874-000 16-16737-000 141700131810		83160
	MotorHomes with Freightliner XC Chassis and ADL200 Suspension w/ 20K Rear	16-16873-000 141700131809 16-16736-000			85029

INDEPENDENCE

00-11	MotorHomes with Ford E350 or E450 Chassis	8C2Z-18124-D 8C24-18045-DA ASH-1154 AT-163G		G63622	58622 77614						
		8C24-18080-DB ASH-1136 8C2Z-18125-D AT-164G		G63623	58623 77623
02	Models with Freightliner XC Chassis with ZF - IFS Front Suspension and 23,000 lb GVW or Greater	16-18103-000 481700000493		85900						
	MotorHomes with Freightliner XC Chassis and ADL200 Suspension w/ 20K Rear	16-16873-000 141700131809 16-16736-000			85029
	MotorHomes with Freightliner XC Chassis and AS120 Front Suspension	16-16874-000 16-16737-000 141700131810		83160

MONTAJ

10-11	MotorHomes with Ford E350 or E450 Chassis	8C2Z-18124-D 8C24-18045-DA ASH-1154 AT-163G		G63622	58622 77614						
		8C24-18080-DB ASH-1136 8C2Z-18125-D AT-164G		G63623	58623 77623

SCENIC CRUISER

02-06	Models with Freightliner XC Chassis with ZF - IFS Front Suspension and 23,000 lb GVW or Greater	16-18103-000 481700000493		85900						
	MotorHomes with Freightliner XC Chassis & AS120 Front Suspension AS120 Front Suspension	16-16874-000 16-16737-000 141700131810		83160
	MotorHomes with Freightliner XC Chassis and ADL200 Suspension w/ 20K Rear	16-16873-000 141700131809 16-16736-000			85029



ULTRA

00-08	MotorHomes with Ford E350 or E450 Chassis	ASH-1154		G63622	58622 77614						
		ASH-1136		G63623	58623 77623

YELLOWSTONE

05-11	MotorHomes with Ford E350 or E450 Chassis	8C2Z-18124-D 8C24-18045-DA ASH-1154 AT-163G		G63622	58622 77614						
-------	---	--	--	------	--------	----------------	------	--	--	--	--	--	--

APPLICATION GUIDE

Year	Fitment Notes	OEM#								
			Fleetline\ Gas SLX	Classic\ Ultra\ ProGuard\ Guardian	Max Control\ LTV Severe Duty\ Load Carrier\ HiJackers\ OffGrid Nomads	Steering Dampers\ Steering Stabilizer\ Cab Shock	Fleetline\ Gas SLX	Classic\ Ultra\ ProGuard\ Guardian	Max Control\ LTV Severe Duty\ Load Carrier\ HiJackers\ OffGrid Nomads	Steering Dampers\ Steering Stabilizer\ Cab Shock

GULF STREAM

GULF STREAM

YELLOWSTONE (cont)

05-11	MotorHomes with Ford E350 or E450 Chassis	8C24-18080-DB ASH-1136 8C2Z-18125-D AT-164G		G63623	58623 77623
02-04	Models with Freightliner XC Chassis with ZF - IFS Front Suspension and 23,000 lb GVW or Greater	16-18103-000 481700000493		85900
	MotorHomes with Ford E350 or E450 Chassis	8C2Z-18124-D 8C24-18045-DA ASH-1154 AT-163G		G63622	58622 77614
		8C24-18080-DB ASH-1136 8C2Z-18125-D AT-164G		G63623	58623 77623
	MotorHomes with Freightliner XC Chassis & AS120 Front Suspension	16-16874-000 16-16737-000 141700131810		83160
	MotorHomes with Freightliner XC Chassis and ADL200 Suspension w/ 20K Rear	16-16873-000 141700131809 16-16736-000			85029

HENDRICKSON

HENDRICKSON

SCT10

11-23	Self Steer Lift Axle with O.E.M Number	R-009596, R009596, R-009600, R009600		646218
-------	--	---	--	-------	-------	-------	-------	--	-------	-------	--------	-------

SCT13

11-23	Self Steer Lift Axle with O.E.M Number	R-009596, R009596, R-009600, R009600		646218
-------	--	---	--	-------	-------	-------	-------	--	-------	-------	--------	-------

HINO

HINO

145

05-10	Models with O.E.M. Number	S4850-03710 48500-3710A 48500-3710		83126
-------	---------------------------	--	--	-------	-------	-------	-------	--	-------	-------	-------	-------

155

13-20	Models with O.E.M. Number	48511-80162 48511-37320		83518
		48531-37351			83519

165

05-10	Models with O.E.M. Number	S4850-03710 48500-3710A 48500-3710		83126
-------	---------------------------	--	--	-------	-------	-------	-------	--	-------	-------	-------	-------



185

05-10	Models with O.E.M. Number	S4850-03710 48500-3710A 48500-3710		83126
		48500-3720 S4850-03720		83140

195

21	Models with O.E.M. Number	48511-80162 48511-37320		83518
		48531-37362 48531-37361			83519
12-20	Models with O.E.M. Number	48511-80162 48511-37320		83518
		48531-37362 48531-37361			83519

APPLICATION GUIDE

Year	Fitment Notes	OEM#								
			Fleetline\ Gas SLX	Classic\ Ultra\ ProGuard\ Guardian	Max Control\ LTV Severe Duty\ Load Carrier\ Hijackers\ OffGrid Nomads	Steering Dampers\ Steering Stabilizer\ Cab Shock	Fleetline\ Gas SLX	Classic\ Ultra\ ProGuard\ Guardian	Max Control\ LTV Severe Duty\ Load Carrier\ Hijackers\ OffGrid Nomads	Steering Dampers\ Steering Stabilizer\ Cab Shock

HINO

HINO

238

08-14	Models with Hendrickson Comfort Air (Single Axle - 19K)	48530-E0100 60670-014L 60670-031L 60670-019L 60670-029L	83166
05-14	Models with O.E.M. Number	48500-3720 S4850-03720	83140

258

15-20	Models with O.E.M. Number	48500-E0420	83391
08-20	Models with Hendrickson Comfort Air (Single Axle - 19K)	48530-E0100 60670-014L 48530-E0390 60670-031L 60670-019L 60670-029L	83166
06-14	Models with O.E.M. Number	48500-3720 S4850-03720	83140

258ALP

08-14	Models with Hendrickson Comfort Air (Single Axle - 19K)	48530-E0100 60670-014L 60670-031L 60670-019L 60670-029L	83166
-------	---	---	-----	-----	-----	-----	-----	-------	-----	-----	-----

258LP

15-20	Models with O.E.M. Number	48500-E0420	83391
-------	---------------------------	-------------	-------	-----	-----	-----	-----	-----	-----	-----	-----

268

15-20	Models with O.E.M. Number	48500-E0420	83391
08-20	Models with Hendrickson Comfort Air (Single Axle - 19K)	48530-E0100 60670-014L 48530-E0390 60670-031L 60670-019L 60670-029L	83166
05-14	Models with O.E.M. Number	48500-3720 S4850-03720	83140

268, 268A SERIES

	Models with Hendrickson Rear Air Suspension (Shock stamping #)	60670-012	83168
--	--	-----------	-----	-----	-----	-----	-----	-------	-----	-----	-----

268A

08-14	Models with Hendrickson Comfort Air (Single Axle - 19K)	48530-E0100 60670-014L 60670-031L 60670-019L 60670-029L	83166
	Models with O.E.M. Number	48500-3720 S4850-03720	83140

ADDITIONAL APPLICATIONS

	Conventional Hino Models with Hendrickson Comfort Air Suspension	60670-020	83148
	Conventional Hino Models with Hendrickson Comfort Air Suspension (19,000 lb & 21,000 lb Capacity)	60670-013	83148



FA, FB SERIES

98	FA1517, FA1817, FB1817	G63419
----	------------------------	-------	-----	-----	-----	-----	-----	-----	--------	-----	-----

FA14

89-91	FA, FB Models Trucks with:	S4853-01910	83216
-------	----------------------------	-------------	-----	-----	-----	-----	-----	-------	-----	-----	-----

APPLICATION GUIDE

Year	Fitment Notes	OEM#								
			Fleetline\ Gas SLX	Classic\ Ultra\ ProGuard\ Guardian	Max Control\ LTV Severe Duty\ Load Carrier\ HiJackers\ OffGrid Nomads	Steering Dampers\ Steering Stabilizer\ Cab Shock	Fleetline\ Gas SLX	Classic\ Ultra\ ProGuard\ Guardian	Max Control\ LTV Severe Duty\ Load Carrier\ HiJackers\ OffGrid Nomads	Steering Dampers\ Steering Stabilizer\ Cab Shock

HINO

HINO

FA14 (cont)

89-91	Models with O.E.M. Number	S4850-01950 48500-1950 48500-2750 S4850-02750 66639	 O		G63610								
-------	---------------------------	---	-------	--	--------	--	--	--	--	--	--	--	--

FA15

92	FA, FB Models Trucks with:	S4850-01950 48500-1950 48500-2750 S4850-02750 66639	 O		G63610								
		S4853-02510 S4853-01910 48530-2510 34802 48530-1910	 O					83216					

FA1415

93-97	(FA15)	48500-1950	 O		G63610									
		48530-1910	 O					83216						
	FA, FB Models Trucks with:	S4850-01950 48500-1950 48500-2750 S4850-02750 66639	 O											
		S4853-02510 S4853-01910 48530-2510 34802 48530-1910	 O					83216						
		FA1415 (FA15), FB1715 (FB15)	 O											
		48530-1910	 O					83216						

FA1517

98-04	FA, FB Models Trucks with:	S4850-01950 48500-1950 48500-2750 S4850-02750 66639	 O		G63610								
		S4853-02510 S4853-01910 48530-2510 34802 48530-1910	 O					83216					
98	All	48530-2510	 O										
	FA1517, FA1817, FB1817	48530-2510	 O					83216					

FA1817

98	All	48530-2510	 O										
----	-----	------------	-------	--	--	--	--	--	--	--	--	--	--

FB14

89-91	FA, FB Models Trucks with:	S4850-01950 48500-1950 48500-2750 S4850-02750 66639	 O		G63610								
		S4853-02510 S4853-01910 48530-2510 34802 48530-1910	 O					83216					

FB15

92	FA, FB Models Trucks with:	S4850-01950 48500-1950 48500-2750 S4850-02750 66639	 O		G63610								
----	----------------------------	---	-------	--	--------	--	--	--	--	--	--	--	--

APPLICATION GUIDE

Year	Fitment Notes	OEM#								
			Fleetline\ Gas SLX	Classic\ Ultra\ ProGuard\ Guardian	Max Control\ LTV Severe Duty\ Load Carrier\ Hijackers\ OffGrid Nomads	Steering Dampers\ Steering Stabilizer\ Cab Shock	Fleetline\ Gas SLX	Classic\ Ultra\ ProGuard\ Guardian	Max Control\ LTV Severe Duty\ Load Carrier\ Hijackers\ OffGrid Nomads	Steering Dampers\ Steering Stabilizer\ Cab Shock

HINO

HINO

FB15 (cont)

92	FA, FB Models Trucks with:	S4853-02510 S4853-01910 48530-2510 34802 48530-1910											
----	----------------------------	---	--	--	--	--	--	--	--	--	--	--	--

FB1715

93-97	FA, FB Models Trucks with:	S4850-01950 48500-1950 48500-2750 S4850-02750 66639			G63610									
		S4853-02510 S4853-01910 48530-2510 34802 48530-1910												
	FA1415 (FA15), FB1715 (FB15)	48500-1950			G63610									
		48530-1910												

FB1817

98-04	FA, FB Models Trucks with:	S4850-01950 48500-1950 48500-2750 S4850-02750 66639			G63610								
		S4853-02510 S4853-01910 48530-2510 34802 48530-1910											
	FE Models Trucks with:	S4850-01941 48500-1941			83141								
98	All	48530-2510											
	FA1517, FA1817, FB1817	48530-2510											

FD16

86-87	Models with O.E.M. Number	48530-1880											
-------	---------------------------	------------	--	--	--	--	--	--	--	--	--	--	--

FD17

88-92	Models with O.E.M. Number	48530-1880											
-------	---------------------------	------------	--	--	--	--	--	--	--	--	--	--	--

FD2218

93-97	(FD5H). FE5H, FF5H	48500-1801			83216								
		48530-1880											

FD2218LD

93-97	(FD5H). FE5H, FF5H	48530-1880											
-------	--------------------	------------	--	--	--	--	--	--	--	--	--	--	--

FD2218LP

93-97	Models with O.E.M. Number	48500-1801			83216								
		48530-1880											

FE SERIES

98-04	Models Trucks with O.E.M. Number	S4850-01941 48500-1941			83141								
-------	----------------------------------	---------------------------	--	--	-------	--	--	--	--	--	--	--	--



FE16

86-87	All	48500-1801			83216								
-------	-----	------------	--	--	-------	--	--	--	--	--	--	--	--

FE2620

98	All	48530-1880											
----	-----	------------	--	--	--	--	--	--	--	--	--	--	--

APPLICATION GUIDE

Year	Fitment Notes	OEM#								
			Fleetline\ Gas SLX	Classic\ Ultra\ ProGuard	Max Control\ LTV Severe Duty\ Load Carrier\ HiJackers\ OffGrid Nomads	Steering Dampers\ Steering Stabilizer\ Cab Shock	Fleetline\ Gas SLX	Classic\ Ultra\ ProGuard	Max Control\ LTV Severe Duty\ Load Carrier\ HiJackers\ OffGrid Nomads	Steering Dampers\ Steering Stabilizer\ Cab Shock

HINO

HINO

GC17

90-91	GC17	48500-1801	O/O	83216
-------	------	------------	-----	-------	------	------	------	------	------	------

GC20

92	GC20	48500-1801	O/O	83216
----	------	------------	-----	-------	------	------	------	------	------	------

L6

22-24	Models with Hendrickson Comfort Air (Single Axle - 19K)	48530-E0100 60670-014L 48530-E0390 60670-031L 60670-019L 60670-029L	O/O	83166
	Models with O.E.M. Number	48500-E0420	O/O	83391
21-24	Models with Hendrickson Comfort Air (Single Axle - 19K, 21K & 23K)	48530-E0100 48530-E0390 60670-030L 60670-031 48530-E0290 60670-029L	O/O	83166
	Models with O.E.M. Number	48500-E0420	O/O	83391
21	Models with Hendrickson Comfort Air (Single Axle - 19K)	48530-E0100 60670-014L 60670-031L 60670-019L 60670-029L	O/O	83166
	Models with O.E.M. Number	48500-E0420	O/O	83391



HOLIDAY RAMBLER

HOLIDAY RAMBLER

ADMIRAL

16-24	MotorHomes with Ford F53 Chassis with 16,000 lb GVW to 22,000 lb GVW	ASH-1229 ASH-1228 9U94-18045-AA ASH-1205 AT-620 ASH-1022 1C34-18045-AA ASH-294 9U9Z-18124-A ASH-25822 ASH-25823 1C34-18045-JA AT-766	O/O	83209
	MotorHomes with Ford F53 Chassis with 16,000 lb GVW to 22,000 lb GVW	ASH-1206 9U94-18080-AA AT-621 ASH-25824 9U9Z-18125-A ASH-1023 ASH-1230 ASH-137	O/O	83122 89406
11-15	MotorHomes with Ford F53 Chassis with 16,000 lb GVW to 22,000 lb GVW	ASH-1229 ASH-1228 9U94-18045-AA ASH-1205 AT-620 ASH-1022 1C34-18045-AA ASH-294 9U9Z-18124-A ASH-25822 ASH-25823 1C34-18045-JA AT-766	O/O	83209
	MotorHomes with Ford F53 Chassis with 16,000 lb GVW to 22,000 lb GVW	ASH-1206 9U94-18080-AA AT-621 ASH-25824 9U9Z-18125-A ASH-1023 ASH-1230 ASH-137	O/O	83122 89406

APPLICATION GUIDE

Year	Fitment Notes	OEM#								
			Fleetline\ Gas SLX	Classic\ Ultra\ ProGuard\ Guardian	Max Control\ LTV Severe Duty\ Load Carrier\ Hijackers\ OffGrid Nomads	Steering Dampers\ Steering Stabilizer\ Cab Shock	Fleetline\ Gas SLX	Classic\ Ultra\ ProGuard\ Guardian	Max Control\ LTV Severe Duty\ Load Carrier\ Hijackers\ OffGrid Nomads	Steering Dampers\ Steering Stabilizer\ Cab Shock

HOLIDAY RAMBLER

HOLIDAY RAMBLER



ADMIRAL (cont)

07-10	MotorHomes with Ford F53 Chassis with 16,000 lb GVW to 22,000 lb GVW	ASH-1229 ASH-1228 9U94-18045-AA ASH-1205 AT-620 ASH-1022 1C34-18045-AA ASH-294 9U9Z-18124-A ASH-25822 ASH-25823 1C34-18045-JA AT-766	OIO	83209
		ASH-1206 9U94-18080-AA AT-621 ASH-25824 9U9Z-18125-A ASH-1023 ASH-1230 ASH-137	OIO	83122 89406
02-06	MotorHomes with Ford F53 Chassis with 16,000 lb GVW to 22,000 lb GVW	ASH-1229 ASH-1228 9U94-18045-AA ASH-1205 AT-620 ASH-1022 1C34-18045-AA ASH-294 9U9Z-18124-A ASH-25822 ASH-25823 1C34-18045-JA AT-766	OIO	83209
		ASH-1206 9U94-18080-AA AT-621 ASH-25824 9U9Z-18125-A ASH-1023 ASH-1230 ASH-137	OIO	83122 89406
00-01	Models with Workhorse W22 Chassis with 8.1L Gas V8	01809925	OIO	85010
	MotorHomes with Ford F53 Chassis with 16,000 lb GVW to 22,000 lb GVW	ASH-1229 ASH-1228 9U94-18045-AA ASH-1205 AT-620 ASH-1022 1C34-18045-AA ASH-294 9U9Z-18124-A ASH-25822 ASH-25823 1C34-18045-JA AT-766	OIO	83209
		ASH-1206 9U94-18080-AA AT-621 ASH-25824 9U9Z-18125-A ASH-1023 ASH-1230 ASH-137	OIO	83122 89406

ADMIRAL SE

02-06	MotorHomes with Ford F53 Chassis with 16,000 lb GVW to 22,000 lb GVW	ASH-1229 ASH-1228 9U94-18045-AA ASH-1205 AT-620 ASH-1022 1C34-18045-AA ASH-294 9U9Z-18124-A ASH-25822 ASH-25823 1C34-18045-JA AT-766	OIO	83209
-------	--	--	-----	-------	------	------	------	------	------	------	------	------

APPLICATION GUIDE

Year	Fitment Notes	OEM#								
			Fleetline\ Gas SLX	Classic\ Ultra\ ProGuard\ Guardian	Max Control\ LTV Severe Duty\ Load Carrier\ HiJackers\ OffGrid Nomads	Steering Dampers\ Steering Stabilizer\ Cab Shock	Fleetline\ Gas SLX	Classic\ Ultra\ ProGuard\ Guardian	Max Control\ LTV Severe Duty\ Load Carrier\ HiJackers\ OffGrid Nomads	Steering Dampers\ Steering Stabilizer\ Cab Shock

HOLIDAY RAMBLER

HOLIDAY RAMBLER

ADMIRAL SE (cont)

02-06	MotorHomes with Ford F53 Chassis with 16,000 lb GVW to 22,000 lb GVW	ASH-1206 9U94-18080-AA AT-621 ASH-25824 9U9Z-18125-A ASH-1023 ASH-1230 ASH-137								83122 89406			
-------	--	---	--	--	--	--	--	--	--	----------------	--	--	--

ADMIRAL SVE

07	MotorHomes with Ford F53 Chassis with 16,000 lb GVW to 22,000 lb GVW	ASH-1229 ASH-1228 9U94-18045-AA ASH-1205 AT-620 ASH-1022 1C34-18045-AA ASH-294 9U9Z-18124-A ASH-25822 ASH-25823 1C34-18045-JA AT-766		83209									
		ASH-1206 9U94-18080-AA AT-621 ASH-25824 9U9Z-18125-A ASH-1023 ASH-1230 ASH-137									83122 89406		

ADMIRAL XE

16-18	MotorHomes with Ford F53 Chassis with 16,000 lb GVW to 22,000 lb GVW	ASH-1229 ASH-1228 9U94-18045-AA ASH-1205 AT-620 ASH-1022 1C34-18045-AA ASH-294 9U9Z-18124-A ASH-25822 ASH-25823 1C34-18045-JA AT-766		83209									
		ASH-1206 9U94-18080-AA AT-621 ASH-25824 9U9Z-18125-A ASH-1023 ASH-1230 ASH-137									83122 89406		



ALTERA

19	MotorHomes with Ford E450 Chassis	8C2Z-18124-D 8C24-18045-DA ASH-1154 AT-163G		G63622	58622 77614								
		8C24-18080-DB ASH-1136 8C2Z-18125-D AT-164G									G63623	58623 77623	
18	MotorHomes with Ford E450 Chassis	8C2Z-18124-D 8C24-18045-DA ASH-1154 AT-163G		G63622	58622 77614								
		8C24-18080-DB ASH-1136 8C2Z-18125-D AT-164G								G63623	58623 77623		

ATLANTIS

09-10	MotorHomes with Ford E450 Chassis	8C2Z-18124-D 8C24-18045-DA ASH-1154 AT-163G		G63622	58622 77614								
-------	-----------------------------------	--	--	--------	----------------	--	--	--	--	--	--	--	--

APPLICATION GUIDE

Year	Fitment Notes	OEM#								
			Fleetline/ Gas SLX	Classic/ Ultra/ ProGuard/ Guardian	Max Control/ LTV Severe Duty/ Load Carrier/ HiJackers/ OffGrid Nomads	Steering Dampers/ Steering Stabilizer/ Cab Shock	Fleetline/ Gas SLX	Classic/ Ultra/ ProGuard/ Guardian	Max Control/ LTV Severe Duty/ Load Carrier/ HiJackers/ OffGrid Nomads	Steering Dampers/ Steering Stabilizer/ Cab Shock

HOLIDAY RAMBLER

ATLANTIS (cont)

09-10	MotorHomes with Ford E450 Chassis	8C24-18080-DB ASH-1136 8C2Z-18125-D AT-164G		G63623	58623 77623
08	MotorHomes with Ford E450 Chassis	8C2Z-18124-D 8C24-18045-DA ASH-1154 AT-163G		G63622	58622 77614
		8C24-18080-DB ASH-1136 8C2Z-18125-D AT-164G		G63623	58623 77623
07	MotorHomes with Ford E450 Chassis	8C2Z-18124-D 8C24-18045-DA ASH-1154 AT-163G		G63622	58622 77614
		8C24-18080-DB ASH-1136 8C2Z-18125-D AT-164G		G63623	58623 77623
06	MotorHomes with Ford E450 Chassis	8C2Z-18124-D 8C24-18045-DA ASH-1154 AT-163G		G63622	58622 77614
		8C24-18080-DB ASH-1136 8C2Z-18125-D AT-164G		G63623	58623 77623
02-05	MotorHomes with Ford E450 Chassis	8C2Z-18124-D 8C24-18045-DA ASH-1154 AT-163G		G63622	58622 77614
		8C24-18080-DB ASH-1136 8C2Z-18125-D AT-164G		G63623	58623 77623
99-01	MotorHomes with Ford E450 Chassis	8C2Z-18124-D 8C24-18045-DA ASH-1154 AT-163G		G63622	58622 77614
		8C24-18080-DB ASH-1136 8C2Z-18125-D AT-164G		G63623	58623 77623

HOLIDAY RAMBLER

AUGUSTA

19	MotorHomes with Ford E450 Chassis	8C2Z-18124-D 8C24-18045-DA ASH-1154 AT-163G		G63622	58622 77614
		8C24-18080-DB ASH-1136 8C2Z-18125-D AT-164G		G63623	58623 77623
15-16	MotorHomes with Ford E450 Chassis	8C2Z-18124-D 8C24-18045-DA ASH-1154 AT-163G		G63622	58622 77614
		8C24-18080-DB ASH-1136 8C2Z-18125-D AT-164G		G63623	58623 77623
11	MotorHomes with Ford E450 Chassis	8C2Z-18124-D 8C24-18045-DA ASH-1154 AT-163G		G63622	58622 77614
		8C24-18080-DB ASH-1136 8C2Z-18125-D AT-164G		G63623	58623 77623
08-09	MotorHomes with Ford E450 Chassis	8C2Z-18124-D 8C24-18045-DA ASH-1154 AT-163G		G63622	58622 77614

APPLICATION GUIDE

Year	Fitment Notes	OEM#								
			Fleetline/ Gas SLX	Classic/ Ultra/ ProGuard/ Guardian	Max Control/ LTV Severe Duty/ Load Carrier/ HiJackers/ OffGrid Nomads	Steering Dampers/ Steering Stabilizer/ Cab Shock	Fleetline/ Gas SLX	Classic/ Ultra/ ProGuard/ Guardian	Max Control/ LTV Severe Duty/ Load Carrier/ HiJackers/ OffGrid Nomads	Steering Dampers/ Steering Stabilizer/ Cab Shock

HOLIDAY RAMBLER

HOLIDAY RAMBLER

AUGUSTA (cont)

08-09	MotorHomes with Ford E450 Chassis	8C24-18080-DB ASH-1136 8C2Z-18125-D AT-164G		O		O	G63623	58623 77623
-------	-----------------------------------	--	--	---	------	------	------	------	--	---	------	--------	----------------	------

AUGUSTA B+

12-13	MotorHomes with Ford E450 Chassis	8C2Z-18124-D 8C24-18045-DA ASH-1154 AT-163G		O	G63622	58622 77614		O
		8C24-18080-DB ASH-1136 8C2Z-18125-D AT-164G		O		O	G63623	58623 77623
10	MotorHomes with Ford E450 Chassis	8C2Z-18124-D 8C24-18045-DA ASH-1154 AT-163G		O	G63622	58622 77614		O
		8C24-18080-DB ASH-1136 8C2Z-18125-D AT-164G		O		O	G63623	58623 77623
07	MotorHomes with Ford E450 Chassis	8C2Z-18124-D 8C24-18045-DA ASH-1154 AT-163G		O	G63622	58622 77614		O
		8C24-18080-DB ASH-1136 8C2Z-18125-D AT-164G		O		O	G63623	58623 77623

AUGUSTA LX

16	MotorHomes with Ford E450 Chassis	8C2Z-18124-D 8C24-18045-DA ASH-1154 AT-163G		O	G63622	58622 77614		O
		8C24-18080-DB ASH-1136 8C2Z-18125-D AT-164G		O		O	G63623	58623 77623

AUGUSTA SPORT

07-10	MotorHomes with Ford E350 Chassis	8C2Z-18124-D 8C24-18045-DA ASH-1154 AT-163G		O	G63622	58622 77614		O
		8C24-18080-DB ASH-1136 8C2Z-18125-D AT-164G		O		O	G63623	58623 77623

AUGUSTA TOURING SEDAN

07-09	MotorHomes with Ford E350 Chassis	8C2Z-18124-D 8C24-18045-DA ASH-1154 AT-163G		O	G63622	58622 77614		O
		8C24-18080-DB ASH-1136 8C2Z-18125-D AT-164G		O		O	G63623	58623 77623

CLASS A MOTORHOMES

04-11	Models with Workhorse W20 , W22, & W24 MotorHome Chassis with O.E.M. Number	W0005663 F4-BE5-F325-HO 24-153256		T		T	85124
98-11	Models with Workhorse W20 , W22, & W24 MotorHome Chassis with O.E.M. Number	24-153249 F4-BE5-B492-HO W0005662 W0006254 24153249 24-186629 F4-BE5-A832-MO F4-BE5-F324-HO		O	85125		O
00-03	Models with Roadmaster Chassis RM4C or used on Ambassador	01809924		O	83144		O

APPLICATION GUIDE

Year	Fitment Notes	OEM#								
			Fleetline\ Gas SLX	Classic\ Ultra\ ProGuard\ Guardian	Max Control\ LTV Severe Duty\ Load Carrier\ Hijackers\ OffGrid Nomads	Steering Dampers\ Steering Stabilizer\ Cab Shock	Fleetline\ Gas SLX	Classic\ Ultra\ ProGuard\ Guardian	Max Control\ LTV Severe Duty\ Load Carrier\ Hijackers\ OffGrid Nomads	Steering Dampers\ Steering Stabilizer\ Cab Shock

HOLIDAY RAMBLER

HOLIDAY RAMBLER

CLASS A MOTORHOMES (cont)

00-03	Models with Roadmaster Chassis RM4C or used on Ambassador	01809923	00	85029
95-99	MotorHomes with Freightliner XC Chassis (22,000 to 26,000 lb GVW)	00	83160	00	85029



ECLIPSE

23-24	MotorHomes with Ford F53 Chassis with 16,000 lb GVW to 22,000 lb GVW	9U9Z-18124-A ASH-25822 ASH-25823 HU9Z-18124-B HU9Z-18124-C	00	83209
		ASH-25824 9U9Z-18125-A HU9Z-18125-B	00	00	83122 89406

ENDEAVOR

16-24	MotorHomes with Ford F53 Chassis with 16,000 lb GVW to 22,000 lb GVW	ASH-1229 ASH-1228 9U94-18045-AA ASH-1205 AT-620 ASH-1022 1C34-18045-AA ASH-294 9U9Z-18124-A ASH-25822 ASH-25823 1C34-18045-JA AT-766	00	83209
		ASH-1206 9U94-18080-AA AT-621 ASH-25824 9U9Z-18125-A ASH-1023 ASH-1230 ASH-137	00	00	83122 89406
15	MotorHomes with Ford F53 Chassis with 16,000 lb GVW to 22,000 lb GVW	ASH-1229 ASH-1228 9U94-18045-AA ASH-1205 AT-620 ASH-1022 1C34-18045-AA ASH-294 9U9Z-18124-A ASH-25822 ASH-25823 1C34-18045-JA AT-766	00	83209
		ASH-1206 9U94-18080-AA AT-621 ASH-25824 9U9Z-18125-A ASH-1023 ASH-1230 ASH-137	00	00	83122 89406
00-14	MotorHomes with Ford F53 Chassis with 16,000 lb GVW to 22,000 lb GVW	ASH-1229 ASH-1228 9U94-18045-AA ASH-1205 AT-620 ASH-1022 1C34-18045-AA ASH-294 9U9Z-18124-A ASH-25822 ASH-25823 1C34-18045-JA AT-766	00	83209
		ASH-1206 9U94-18080-AA AT-621 ASH-25824 9U9Z-18125-A ASH-1023 ASH-1230 ASH-137	00	00	83122 89406

APPLICATION GUIDE

Year	Fitment Notes	OEM#								
			Fleetline\ Gas SLX	Classic\ Ultra\ ProGuard\ Guardian	Max Control\ LTV Severe Duty\ Load Carrier\ HIJackers\ OffGrid Nomads	Steering Dampers\ Steering Stabilizer\ Cab Shock	Fleetline\ Gas SLX	Classic\ Ultra\ ProGuard\ Guardian	Max Control\ LTV Severe Duty\ Load Carrier\ HIJackers\ OffGrid Nomads	Steering Dampers\ Steering Stabilizer\ Cab Shock

HOLIDAY RAMBLER

HOLIDAY RAMBLER

ENDEAVOR (cont)

00-03	Models with Workhorse W22 Chassis with 8.1L Gas V8	01809925	OO	85010
-------	--	----------	----	-------	------	------	------	------	------	------	------



INVICTA

20-24	MotorHomes with Ford F53 Chassis with 24,000 lb GVW to 26,000 lb GVW	ASH-25821 ASH-1161	OO	85006
20-23	MotorHomes with Ford F53 Chassis with 24,000 lb GVW to 26,000 lb GVW	ASH-25820 ASH-1162	OO	85005 89430

VACATIONER

11-24	MotorHomes with Ford F53 Chassis with 16,000 lb GVW to 22,000 lb GVW	ASH-1229 ASH-1228 9U94-18045-AA ASH-1205 AT-620 ASH-1022 1C34-18045-AA ASH-294 9U9Z-18124-A ASH-25822 ASH-25823 1C34-18045-JA AT-766	OO	83209	
		ASH-1206 9U94-18080-AA AT-621 ASH-25824 9U9Z-18125-A ASH-1023 ASH-1230 ASH-137	OO	83122 89406
		MotorHomes with Ford F53 Chassis with 24,000 lb GVW to 26,000 lb GVW	ASH-25821 ASH-1161	OO	85006
11-23	MotorHomes with Ford F53 Chassis with 24,000 lb GVW to 26,000 lb GVW	ASH-25820 ASH-1162	OO	85005 89430	
09	MotorHomes with Ford F53 Chassis with 16,000 lb GVW to 22,000 lb GVW	ASH-1229 ASH-1228 9U94-18045-AA ASH-1205 AT-620 ASH-1022 1C34-18045-AA ASH-294 9U9Z-18124-A ASH-25822 ASH-25823 1C34-18045-JA AT-766	OO	83209	
		ASH-1206 9U94-18080-AA AT-621 ASH-25824 9U9Z-18125-A ASH-1023 ASH-1230 ASH-137	OO	83122 89406
		MotorHomes with Ford F53 Chassis with 24,000 lb GVW to 26,000 lb GVW	ASH-25821 ASH-1161	OO	85006
		ASH-25820 ASH-1162	OO	85005 89430	
00-07	MotorHomes with Ford F53 Chassis with 16,000 lb GVW to 22,000 lb GVW	ASH-1229 ASH-1228 9U94-18045-AA ASH-1205 AT-620 ASH-1022 1C34-18045-AA ASH-294 9U9Z-18124-A ASH-25822 ASH-25823 1C34-18045-JA AT-766	OO	83209	

APPLICATION GUIDE

Year	Fitment Notes	OEM#								
			Fleetline\ Gas SLX	Classic\ Ultra\ ProGuard\ Guardian	Max Control\ LTV Severe Duty\ Load Carrier\ Hijackers\ OffGrid Nomads	Steering Dampers\ Steering Stabilizer\ Cab Shock	Fleetline\ Gas SLX	Classic\ Ultra\ ProGuard\ Guardian	Max Control\ LTV Severe Duty\ Load Carrier\ Hijackers\ OffGrid Nomads	Steering Dampers\ Steering Stabilizer\ Cab Shock

HOLIDAY RAMBLER

VACATIONER (cont)

00-07	MotorHomes with Ford F53 Chassis with 16,000 lb GVW to 22,000 lb GVW	ASH-1206 9U94-18080-AA AT-621 ASH-25824 9U9Z-18125-A ASH-1023 ASH-1230 ASH-137		83122 89406
00-03	Models with Workhorse W22 Chassis with 8.1L Gas V8	01809925	85010

HOLIDAY RAMBLER

VARIOUS

	Models with Mor-Ryde Suspension	U0109-007	G63183
	Models with Neway Trailer Air Suspension	90044794	83127

VESTA

17-18	MotorHomes with Ford E450 Chassis	8C2Z-18124-D 8C24-18045-DA ASH-1154 AT-163G	...	G63622	58622 77614
		8C24-18080-DB ASH-1136 8C2Z-18125-D AT-164G	G63623	58623 77623	...

INTERNATIONAL

4200

02-10	With 10,000lb - 14,000lb Axle	3533357C1	85928
	with 6,000lb - 8,000lb Axle	3533356C1	85957
	with Tapered Rail, 5.6" Ride Height, W/IAS Suspension	3553628C1	85927

INTERNATIONAL



4300

02-20	Models with 6,000 to 8,000 lb Front Suspension	3533356C1 3533356C2	83135
	Models with Hendrickson HAS - 230 or 460 Rear Air Suspension	60675-003 H60675-003 3514952C1 60675-003L 57905-001	85976
	Models with O.E.M. Number	2509223C92 2509223C91 2509221C91	83054
02-15	Models with 12,000 lb Front axle	3533357C1 3533357C2 3533357C3	85957
02-13	Models with 22,000 lb Rear Spring Suspension	501906C91 501906C92 OE13424S	83317
02-10	With OEM Number	3000094C1 3919925 3609400C2 152C030010 501906C91 501906C92 13424S 3000098C1	83317
08-09	Models with 9,000 to 10,000 lb Front Suspension	6127088C1 3578105C2	83163
	Models with International 40,000 lb Rear Air Suspension	3549099C2	85923 89458

4300LP

02-19	Models with O.E.M. Number	2509223C92 2509223C91 2509221C91	83054
13	Models with O.E.M. Number	1660846C92	83101

APPLICATION GUIDE

Year	Fitment Notes	OEM#								
			Fleetline\ Gas SLX	Classic\ Ultra\ ProGuard\ Guardian	Max Control\ LTV Severe Duty\ Load Carrier\ HiJackers\ OffGrid Nomads	Steering Dampers\ Steering Stabilizer\ Cab Shock	Fleetline\ Gas SLX	Classic\ Ultra\ ProGuard\ Guardian	Max Control\ LTV Severe Duty\ Load Carrier\ HiJackers\ OffGrid Nomads	Steering Dampers\ Steering Stabilizer\ Cab Shock

INTERNATIONAL

4400

02-20	Models with 6,000 to 8,000 lb Front Suspension	3533356C1 3533356C2	OO	83135
	Models with Hendrickson HAS - 230 or 460 Rear Air Suspension	60675-003 H60675-003 3514952C1 60675-003L 57905-001	OO	85976
	Models with O.E.M. Number	2509223C92 2509223C91 2509221C91	OO	83054
02-15	Models with 12,000 lb Front axle	3533357C1 3533357C2 3533357C3	OO	85957
02-13	Models with 22,000 lb Rear Spring Suspension	501906C91 501906C92 OE13424S	OO	83317
08-09	Models with 9,000 to 10,000 lb Front Suspension	6127088C1 3578105C2	OO	83163
	Models with International 40,000 lb Rear Air Suspension	3549099C2	OO	85923 89458

INTERNATIONAL

4400LP

02-19	Models with O.E.M. Number	2509223C92 2509223C91 2509221C91	OO	83054
-------	---------------------------	--	----	------	------	------	-------	------	------	------

4700

00-05	With OEM Number	12011044	OO	83203
		586724C91	OO	83456
		1667520C1	OO	85058

4900

00-05	International Corporate Air Suspension	501553C91	OO	85003
	With Dual Doors	2015556C1	OO	85316
	With OEM Number	12011044	OO	83203
		586724C91	OO	83456
		1667520C1	OO	85058

5500I

00-14	Chalmers 854-46	800781	OO	89425
	Hendrickson HAS-402 Air Ride Suspension	60675-003L	OO	85976
		59305-1	OO	85979

8500 TRANSTAR

08-11	Models with International 40,000lb Rear Air Suspension	3549099C1 3549099C2	OO	89458
-------	--	------------------------	----	------	------	------	------	-------	------	------

8600 TRANSTAR

12-18	Models with 10,000 to 14,000 lb Front Axle	6127714C1 3588209C1 3533357C1	OO	85957
	Models with International 40,000lb Rear Air Suspension	3549099C3	OO	89458
08-11	Models with International 40,000lb Rear Air Suspension	3549099C3 3549099C2	OO	89458

A, B, AC AND BC CONVENTIONAL

	A-140 (4 x 4) Models	OO	83216
--	----------------------	------	----	------	------	------	------	-------	------	------

APPLICATION GUIDE

Year	Fitment Notes	OEM#								
			Fleetline\ Gas SLX	Classic\ Ultra\ ProGuard\ Guardian	Max Control\ LTV Severe Duty\ Load Carrier\ Hijackers\ OffGrid Nomads	Steering Dampers\ Steering Stabilizer\ Cab Shock	Fleetline\ Gas SLX	Classic\ Ultra\ ProGuard\ Guardian	Max Control\ LTV Severe Duty\ Load Carrier\ Hijackers\ OffGrid Nomads	Steering Dampers\ Steering Stabilizer\ Cab Shock

INTERNATIONAL

INTERNATIONAL

A, B, AC AND BC CONVENTIONAL (cont)

A-160, A-170, A-180, AC-160, AC-170, AC-180, B-160, B-170, B-180, BC-160, BC-170, BC-180 Models	453567C91 308650C91 308649C91			83216
A-170, B-170, AC-170, ACF-170, BC-170, A-180, B-180, AC-180, BC-180, BCF-170 Models	308646C91	OIO	85012
AB-140 Models	OIO	G63306
AC-170 & BC-170 (4 x 4) Models	OIO	83216
AC-180 & BC-180 (4 x 4) Models	OIO	83216
BCF-195-D Models	OIO	83225
C-150 Models	308668C91	OIO	85012
	OIO	G63306
	453567C91 308649C91	OIO	83216
	453556C91	OIO	85012 89413



BINDER

Binder	453556C91 471201C91 467983C91 467985C91		85012
	453571C91	OIO	83216

CARGOSTAR

CO-1600, CO-1610A & B, CO-1630A & B, CO-1700, CO-1710A & B, CO-1730A & B, CO-1750, CO-1750A & B, CO-1800, CO-1810A & B, CO-1830A & B, CO-1850, and CO-1850A & B	453567C91 467984C91 294334C91 308650C92 206621R92 206620R91 453570C91 3085640C92 308649C91			83216
	467983C91 360444C91 308646C91 453564C91	OIO	85012 89413
CO-1610A & B, CO-1630A & B, CO-1710A & B, CO-1730A & B, CO-1750A & B, CO-1810A & B, CO-1830A & B, COF-1810A & B - Exc. with 9000, 10800, or 12000 lb Front Axle	453572C91	OIO	83309
CO-1610A & B, CO-1630A & B, CO-1710A & B, CO-1730A & B, CO-1750A & B, CO-1810A & B, CO-1830A & B, COF-1810A & B - With 9000, 10800, or 12000 lb Front Axle	873619C93 873619C92	OIO	83314
CO-190, VCO-190, CO-200, DCO-200, VCO-200, CO-220, VCO-220 With Air Ride Suspension After Chassis No G-387453	350425C1 462557C91	OIO	85300 89419
CO-190, VCO-190, CO-200, DCO-200, VCO-200, CO-220, VCO-220 With Air Ride Suspension before Chassis No G-387453	350426C91	OIO	85734
CO-190, COF-190, CO-1950, COF-1950 & COT-1950, VCO-190, VCOF-190 & CO-200, DCO-200, VCO-200 & CO-220, VCO-220 & VCO-190 (4 man cab)	204994R91	OIO	83225

APPLICATION GUIDE

Year	Fitment Notes	OEM#								
			Fleetline\ Gas SLX	Classic\ Ultra\ ProGuard\ Guardian	Max Control\ LTV Severe Duty\ Load Carrier\ HiJackers\ OffGrid Nomads	Steering Dampers\ Steering Stabilizer\ Cab Shock	Fleetline\ Gas SLX	Classic\ Ultra\ ProGuard\ Guardian	Max Control\ LTV Severe Duty\ Load Carrier\ HiJackers\ OffGrid Nomads	Steering Dampers\ Steering Stabilizer\ Cab Shock

INTERNATIONAL

CARGOSTAR (cont)

	CO-190, COF-190, VCO-190, VCOF-190 & CO-200, DCO-200, VCO-200 & CO-220, VCO-220 & VCO-190 (4 man cab)	467372C91 467371C91 453569C91 308648C91 452566C91 453562C91 210534R92 453565C91 288921R92 288920C91 453561C91	OIO	83225
		CO-1910A & B, CO-1950A & B, COF-1910A & B, COF-1950A & B	453572C91 873619C92	OIO OIO	83309 83314
	CO-1950 , COF-1950 & COT-1950	467372C91 467371C91 453569C91 308648C91 453565C91 288921C91 288920C91 453561C91 453566C91	OIO	83225
	CO-1950 with Air Ride Suspension After Chassis No. G-387453	350425C1 462557C91	OIO	85300 89419
	CO-1950 with Air Ride Suspension Before Chassis No. G-387453	350426C1	OIO	85734

INTERNATIONAL

CF500

06-09	w/ vari-rate suspension	3586902C2	OIO	83364
-------	-------------------------	-----------	-----	------	------	------	------	------	-------	------	------	------



CV515

24	Models with 11K, 13.5K or 15.5K VARI-RATE Rear Suspension	4208946C1 4206863C1	OIO	83398
	Models with Taperleaf Front	4109582C1 4089293C1 4109583C1 4207304C1	OIO	83397
19-23	Models with 11K, 13.5K or 15.5K VARI-RATE Rear Suspension	4208946C1 4206863C1	OIO	83398
	Models with 4 x 4 Rear	4109458C2	OIO	83243
	Models with IROS Rear	4214011C2	OIO	85670
	Models with Taperleaf Front	4109582C1 4089293C1 4109583C1 4207304C1	OIO	83397

DURASTAR

16-20	Models with 10,500 or 13,500 lb Vari-Rate Rear Spring Suspension	6127087C1 3586902C2 3586902C3	OIO	83364
	Models with 11,000 lb to 14,000 lb Front axle	6127714C1	OIO	85928
15-20	Models with 6,000 to 8,000 lb Front Suspension	6127688C1 3533356C3	OIO	83169
	Models with Hendrickson HAS - 230 or 460 Rear Air Suspension	60675-003 H60675-003 3514952C1 60675-003L 57905-001	OIO	85976
	Models with O.E.M. Number	2509223C92 2509223C91 2509221C91	OIO	83054
16-19	Models with 20,000 lb International IROS Air Suspension	6127713C1	OIO	85656

APPLICATION GUIDE

Year	Fitment Notes	OEM#								
			Fleetline\ Gas SLX	Classic\ Ultra\ ProGuard\ Guardian	Max Control\ LTV Severe Duty\ Load Carrier\ Hijackers\ OffGrid Nomads	Steering Dampers\ Steering Stabilizer\ Cab Shock	Fleetline\ Gas SLX	Classic\ Ultra\ ProGuard\ Guardian	Max Control\ LTV Severe Duty\ Load Carrier\ Hijackers\ OffGrid Nomads	Steering Dampers\ Steering Stabilizer\ Cab Shock

INTERNATIONAL

DURASTAR (cont)

15-19	Models with 9,000 to 10,000 lb Front Suspension	6127088C1 OE13402S 3578105C2 3578105C1	00	83163
16-17	Models with Vari-Rate Rear Spring Suspension	6127700C1	00	83395
15	Models with 12,000 lb Front axle	3533357C1 3533357C2 3533357C3	00	85957
13	Models with 12,000 lb Front axle	3533357C1 3533357C2 3533357C3	00	85957
	Models with 22,000 lb Rear Spring Suspension	501906C91 501906C92 OE13424S	00	83317
	Models with 6,000 to 8,000 lb Front Suspension	6127688C1 3533356C3	00	83169
	Models with 9,000 to 10,000 lb Front Suspension	6127088C1 OE13402S 3578105C2 3578105C1	00	83163
	Models with Hendrickson HAS - 230 or 460 Rear Air Suspension	60675-003 H60675-003 3514952C1 60675-003L 57905-001	00	85976
	Models with O.E.M. Number	2509223C92 2509223C91 2509221C91	00	83054

INTERNATIONAL

DURASTAR - 1000 SERIES

1300 Models	66400 56110-T8123 56110-T8129	00	G63432
-------------	-------------------------------------	----	------	--------	------	------	------	------	------	------	------

DURASTAR - 4300, 4400 SERIES

	Models with 20,000 lb International IROS Air Suspension To 2015	3578858C1 3578858C2	00	85656
	Models with International IROS Air Suspension	3553628C1 3553628C2 3553628C3 3553628C4	00	85927
	Models with O.E.M. Number	6127690C1	00	85923 89458
16-20	Models with 11,000 lb to 14,000 lb Front axle	6127714C1	00	85928
16-19	Models with 20,000 lb International IROS Air Suspension	6127713C1	00	85656
13-18	Models with 6,000 to 8,000 lb Front Suspension	6127688C1 3533356C3	00	83169
10-15	Models with 12,000 lb Front axle	3533357C1 3533357C2 3533357C3	00	85957
10-12	Models with 6,000 to 8,000 lb Front Suspension	3533356C1 3533356C2	00	83135
	School Bus models with 6,000 to 8,000 lb Front Suspension	3533356C1 3533356C2	00	83135
10-11	Models with 40,000 lb Rear Air Suspension	3549099C2	00	85923 89458

EMV607

23	Models with 12,000 lb Parabolic Taper Leaf Springs	6127714C1	00	85928
----	--	-----------	----	-------	------	------	------	------	------	------	------

M1100 / M1200

68-72	All		00	82007	61500 81147 G63405	43048 ⁸ 49310 ⁷
-------	-----	--	----	------	-------	------	------	------	--------------------------	--	------

APPLICATION GUIDE

Year	Fitment Notes	OEM#								
				Fleetline\ Gas SLX	Classic\ Ultra\ ProGuard\ Guardian	Max Control\ LTV\ Severe Duty\ Load Carrier\ HiJackers\ OffGrid\ Nomads	Steering Dampers\ Steering Stabilizer\ Cab Shock		Fleetline\ Gas SLX	Classic\ Ultra\ ProGuard\ Guardian

INTERNATIONAL

INTERNATIONAL

M1100 / M1200 (cont)

68-72	1/2 & 3/4 Ton with I-Beam Axle		OO							6802SE ⁸⁴
-------	--------------------------------	--	----	--	--	--	--	--	--	----------------------

M1400

69	All		OO		82007							61500 81147 G63405	43048 ⁸ 49310 ⁷	...
	1/2 & 3/4 Ton with I-Beam Axle		OO											

METRO & MULTI-SHOP SERIES

73-75	Multi-Stop Models MS-1210 & 1510		OO									G63306	
66-72	Metro Models M1200 with 14016 Reg. Rear Springs & with 14020 Rear Axle Code		OO												
	Metro Models M1200 with Axle Code 0208 & Frame Code 01000.0962		OO												
	Metro Models M700, 800, 900-U, 1000, 1100,		OO												

MV

20	Models with 20,000 lb International IROS Air Suspension	6127713C2	OO									85656	
	Models with 9,000 to 10,000 lb Front Suspension	6127088C1	OO		83163										
	Models with Hendrickson HAS - 230 or 460 Rear Air Suspension	60675-003 H60675-003 3514952C1 60675-003L		OO										85976	

MV60E

25	Models with 11,000 lb to 14,000 lb Taper Leaf Springs	6127714C1	OO	85928										
	with IROS 20k Rear	6127666C1	OO										85656	

MV607

20-22	Models with 20,000 lb International IROS Air Suspension	6127713C2	OO									85656
19-22	Models with 11,000 lb to 14,000 lb Taper-leaf Springs	6127714C1	OO		85928									
	Models with 6,000 to 8,000 lb Front Suspension	4164146C1 6127688C1	OO		83169									
	Models with 9,000 to 10,000 lb Front Suspension	6127088C1	OO		83163									
	Models with Hendrickson HAS - 230 or 460 Rear Air Suspension	60675-003 H60675-003 3514952C1 60675-003L		OO										85976
	Models with International 21,000 lb Rear Air Suspension	6127666C1		OO										85642

SERIES 1000 FORWARD CONTROL CHASSIS

	1654 LP Models (Low Profile Vehicle)	1660846C91 1660846C92	OO	83101										
--	--------------------------------------	--------------------------	----	-------	--	--	--	--	--	--	--	--	--	--

SERIES 4000 - SHORT CONVENTIONAL MEDIUM TRK & TRAC

	4600, 4700, 4800, 4900 Models	586724C91	IT	83456										
	4600, 4700, 4800, 4900 Models with 10000 lb Front Axle	472412C91	IT											

7 Pair Packs, Air hose kit included.;

8 Pair Packs.;

APPLICATION GUIDE

Year	Fitment Notes	OEM#								
			Fleetline/ Gas SLX	Classic/ Ultra/ ProGuard/ Guardian	Max Control/ LTV Severe Duty/ Load Carrier/ HiJackers/ OffGrid Nomads	Steering Dampers/ Steering Stabilizer/ Cab Shock	Fleetline/ Gas SLX	Classic/ Ultra/ ProGuard/ Guardian	Max Control/ LTV Severe Duty/ Load Carrier/ HiJackers/ OffGrid Nomads	Steering Dampers/ Steering Stabilizer/ Cab Shock

INTERNATIONAL

INTERNATIONAL

SERIES 4000 - SHORT CONVENTIONAL MEDIUM TRK & TRAC (cont)

	F-4900 Models with Hendrickson HN - 400 Models Rear suspension	3515265C1 3515265C2 60680-003L 60680-003 H60680-003		83112									
90-02	F-4900 Models with 10000 lb Front Axle	472412C91		83456									

TERRASTAR

	Models with International IROS Air Suspension	3892445C3		89458									
12-18	Models with 10,500 or 13,500 lb Vari-Rate Rear Spring Suspension	6127087C1 3586902C2 3586902C3		83364									
	Models with 6,000 to 7,000 lb Front Axle	3989717C1 3991991C1 OE 18513 3902993C1 3902993C3 OE17103		83135									
14	4 WD Models with Rear Spring Suspension	6127096C1 3945165C1		83180									

ISUZU

ISUZU

ADDITIONAL APPLICATIONS

85	KS22 Models (All)	8-97083-027-0		83515									
		9-51630-666-2		85012									
		9-51630-666-0		89413									

ALL MODELS WITH

	Models with O.E.M. Number	8-97253-623-0 8-97253-621-0 8-97253-616-0 898098-1270		83515									
--	---------------------------	--	--	-------	--	--	--	--	--	--	--	--	--

EVR

87-93	EVR Models	1-51630-160-0		83162									
-------	------------	---------------	--	-------	--	--	--	--	--	--	--	--	--

FRR

00-04	All	1-51630-219-1 1-51630-219-0 51630219		83114									
95-98	All	1-51630-219-1 1-51630-219-0 51630219		83114									



FSR

86	Models with O.E.M. Number	1-51630-217-1		83114									
		1-51630-160-0		83162									
		51630168 1-51630-168-1		83515									

FTR

20-24	Models with Hendrickson Comfort Air (Single Axle - 21K & 23K)	60670-018 60670-030L 60670-030 48530-E0290 60670-018L		83166									
18-24	Models with Hendrickson HAS suspension	8-97517-966-1 60670-005 60670-005L 8-97517-966-0		83137									
18-20	FTR Diesel Models with Std Cab	8-98321-912-1		85071									
00-11	Models with Hendrickson HAS suspension	8-97517-966-1 60670-005 60670-005L 8-97517-966-0		83137									

APPLICATION GUIDE

Year	Fitment Notes	OEM#								
			Fleetline\ Gas SLX	Classic\ Ultra\ ProGuard\ Guardian	Max Control\ LTV Severe Duty\ Load Carrier\ HiJackers\ OffGrid Nomads	Steering Dampers\ Steering Stabilizer\ Cab Shock	Fleetline\ Gas SLX	Classic\ Ultra\ ProGuard\ Guardian	Max Control\ LTV Severe Duty\ Load Carrier\ HiJackers\ OffGrid Nomads	Steering Dampers\ Steering Stabilizer\ Cab Shock

ISUZU

ISUZU

FTR (cont)

05-09	Models with O.E.M. Number	98098127 8-98232672-0 8-98098-127-0	I O	83515
		98098059 8-98098-059-0 8-98098-059-1 8-98316-228-0	I O
97-09	Models with 19000, 21000, 23000 lb Taperleaf Springs (EXC Low Profile Veh.)	8-22064233-0	I T
90-09	Models with 15000, 19000, 21000 lb Multileaf Springs	15174902 8-22064232-0 88982686	I T
	Models with O.E.M. Number	88982682 8-22064-806-0 8-22064-807-0 15123676	I T	83136
88-96	Models with O.E.M. Number	1-51630-167-0	I T

FVR

	Models with Hendrickson HAS suspension	12474915	O O
--	--	----------	--------	------	------	------	------	------	------	------



HVR

05-08	Conventional Cab W/15000, 19000, 21000lb Multi Leaf Springs	88982686 22064232	I T
	Conventional Cab with OEM Number;	88982682 15192385 15174298 15588554 15887728 15174898 22064230 15123676	I T	83136
	Models with Hendrickson Air Suspension	12474915 15963161	O O
	Truck Cabs with Link Cabmate Model GMC104TK	1201-0054	O O	83021

NPR

95-20	Models with O.E.M. Number	98098059 8-97253-665-0 98098058 8-97253-651-2 8-97253-664-0 97253664 98316227 97253665 97253651 8-98098-058-0 8-98098-058-1 8-98098-059-0 8-98098-059-1 8-98316227-0 8-98316-228-0	O O
		86-20	Models with O.E.M. Number	8-97253-620-1 98098125 8-98381-012-0 97083029 94454987 98232671 8-98381-010-0 97083027 8-98232671-1 8-98232671-0 97253620 8-94454-647-1 8-97253-620-0 8-98098-125-0 8-97083-027-0 9-51630-647-1 8-97083-029-0 51630647 94454986 8-94454-986-0 8-94454-987-0	I O	83515

APPLICATION GUIDE

Year	Fitment Notes	OEM#								
			Fleetline\ Gas SLX	Classic\ Ultra\ ProGuard\ Guardian	Max Control\ LTV Severe Duty\ Load Carrier\ HiJackers\ OffGrid Nomads	Steering Dampers\ Steering Stabilizer\ Cab Shock	Fleetline\ Gas SLX	Classic\ Ultra\ ProGuard\ Guardian	Max Control\ LTV Severe Duty\ Load Carrier\ HiJackers\ OffGrid Nomads	Steering Dampers\ Steering Stabilizer\ Cab Shock

ISUZU

ISUZU

NPR (cont)

86-95	All	9-51630-666-2 51630666 9-51630-666-0			85012 89413
84-85	Models with O.E.M. Number	8-97253-620-1 98098125 8-98381-012-0 97083029 94454987 98232671 8-98381-010-0 97083027 8-98232671-1 8-98232671-0 97253620 8-94454-647-1 8-97253-620-0 8-98098-125-0 8-97083-027-0 9-51630-647-1 8-97083-029-0 51630647 94454986 8-94454-986-0 8-94454-987-0	OI	83515



NPR-HD

20-23	Models with 14,000 to 15,000 lb Rear	8-98380-746-0			83159
	Models with 15,000 to 16,000 lb Rear	8-98380-747-0	OI	83159
03-23	Models with O.E.M. Number	98098059 8-97253-665-0 98098058 8-98098-058-0 8-98098-058-1 8-98098-059-0 8-98098-059-1 8-98316227-0 8-98316-228-0 98316227 97253665	OI	83159
99-23	Models with O.E.M. Number	8-97253-620-1 98098125 8-98381-012-0 97083029 94454987 98232671 8-98381-010-0 97083027 8-98232671-1 8-98232671-0 97253620 8-94454-647-1 8-97253-620-0 8-98098-125-0 8-97083-027-0 9-51630-647-1 8-97083-029-0 51630647 94454986 8-94454-986-0 8-94454-987-0	OI	83515

NPR-XD

23	Models with 14,000 to 15,000 lb GVW	8-98381-010-0		OI	83515
		8-98380-746-0	OI	83159
	Models with 15,000 to 16,000 lb GVW	8-98381-012-0	OI	83515
		8-98380-747-0	OI	83159
15-22	Models with 14,000 to 15,000 lb GVW	8-98381-010-0	OI	83515
		8-98380-746-0	OI	83159
	Models with 15,000 to 16,000 lb GVW	8-98381-012-0	OI	83515

APPLICATION GUIDE

Year	Fitment Notes	OEM#								
			Fleetline\ Gas SLX	Classic\ Ultra\ ProGuard\ Guardian	Max Control\ LTV Severe Duty\ Load Carrier\ HiJackers\ OffGrid Nomads	Steering Dampers\ Steering Stabilizer\ Cab Shock	Fleetline\ Gas SLX	Classic\ Ultra\ ProGuard\ Guardian	Max Control\ LTV Severe Duty\ Load Carrier\ HiJackers\ OffGrid Nomads	Steering Dampers\ Steering Stabilizer\ Cab Shock

ISUZU

ISUZU

NPR-XD (cont)

15-22	Models with 15,000 to 16,000 lb Rear	8-98380-747-0	O O	83159
-------	--------------------------------------	---------------	------	------	------	------	--------	-------	------	------	------



NQR

20-23	Models with 15,000 to 16,000 lb Rear	8-98380-747-0	O O	83159
94-23	Models with O.E.M. Number	8-97253-620-1 98098125 8-98381-012-0 97083029 94454987 98232671 8-98381-010-0 97083027 8-98232671-1 8-98232671-0 97253620 8-94454-647-1 8-97253-620-0 8-98098-125-0 8-97083-027-0 9-51630-647-1 8-97083-029-0 51630647 94454986 8-94454-986-0 8-94454-987-0	83515	O O	83159
03-19	Models with O.E.M. Number	98098059 8-97253-665-0 8-98098-059-0 8-98098-059-1 8-98343986-0 8-98316-228-0 97253665 98343986	O O	83159
02	Diesel	8-97253-664-0 97253664	O O	83159
95-97	Diesel	8-97253-664-0 97253664	O O	83159

NRR

20-23	Models with 15,000 to 16,000 lb Rear	8-98380-747-0	O O	83159
05-23	Models with O.E.M. Number	8-97253-620-1 98098125 8-98381-012-0 97083029 94454987 98232671 8-98381-010-0 97083027 8-98232671-1 8-98232671-0 97253620 8-94454-647-1 8-97253-620-0 8-98098-125-0 8-97083-027-0 9-51630-647-1 8-97083-029-0 51630647 94454986 8-94454-986-0 8-94454-987-0	83515	O O	83159
05-19	Models with O.E.M. Number	98098059 8-97253-665-0 8-98098-059-0 8-98098-059-1 8-98343986-0 8-98316-228-0 97253665 98343986	O O	83159
88-94	All	1-51630-219-1 1-51630-217-1 1-51630-217-0 51630217	83114	O O	83114

APPLICATION GUIDE

Year	Fitment Notes	OEM#								
			Fleetline\ Gas SLX	Classic\ Ultra\ ProGuard\ Guardian	Max Control\ LTV Severe Duty\ Load Carrier\ Hijackers\ OffGrid Nomads	Steering Dampers\ Steering Stabilizer\ Cab Shock	Fleetline\ Gas SLX	Classic\ Ultra\ ProGuard\ Guardian	Max Control\ LTV Severe Duty\ Load Carrier\ Hijackers\ OffGrid Nomads	Steering Dampers\ Steering Stabilizer\ Cab Shock

ISUZU

ISUZU

NRR (cont)

88-94	Models with O.E.M. Number	8-97253-620-1 98098125 8-98381-012-0 97083029 94454987 98232671 8-98381-010-0 97083027 8-98232671-1 8-98232671-0 97253620 8-94454-647-1 8-97253-620-0 8-98098-125-0 8-97083-027-0 9-51630-647-1 8-97083-029-0 51630647 94454986 8-94454-986-0 8-94454-987-0	01	83515
-------	---------------------------	---	----	-------	------	------	------	------	------	------	------

REACH

11-15	Models with O.E.M. Number	8-98381-010-0	01	83515
		8-98380-746-0	01	01	83159



ITASCA

ITASCA

CLASS A MOTORHOMES

	Models with Workhorse UFO Chassis with Hendrickson Softek Front Suspension	66153-002 F4-BE5-C832-MO	01	83124
99-15	SunCruiser Series MotorHomes with Ford F53 Chassis with 16,000 lb GVW to 22,000 lb GVW	ASH-1229 ASH-1228 9U94-18045-AA ASH-1205 AT-620 ASH-1022 1C34-18045-AA ASH-294 9U9Z-18124-A ASH-25822 ASH-25823 1C34-18045-JA AT-766	01	83209
		ASH-1206 9U94-18080-AA AT-621 ASH-25824 9U9Z-18125-A ASH-1023 ASH-1230 ASH-137	01	01	83122 89406
05-11	SunCruiser Series MotorHomes with W20 , W22, & W24 Workhorse Chassis	24-186629	01	85125
04-11	Sunova Models with W20 , W22, & W24 WorkHorse MotorHome Chassis	W0005663 F4-BE5-F325-HO 24-153256	01	01	85124
98-11	Sunova Models with W20 , W22, & W24 WorkHorse MotorHome Chassis	24-153249 W0005662 W0006254 24153249 F4-BE5-A832-MO F4-BE5-F324-HO	01	85125
04-06	Horizon Series MotorHomes with Freightliner XC Chassis ADL200 Suspension w/ 20K Rear	16-16873-000	01	01	85029
	Horizon Series MotorHomes with Freightliner XC Chassis AS120 Front Suspension	16-16874-000 16-16737-000 141700131810	01	83160
	Horizon Series MotorHomes with Freightliner XC Chassis Rear Shock with O.E.M. Number	141700131809 16-16736-000	01	01	85029

APPLICATION GUIDE

Year	Fitment Notes	OEM#								
			Fleetline/ Gas SLX	Classic/ Ultra/ ProGuard/ Guardian	Max Control/ LTV Severe Duty/ Load Carrier/ HiJackers/ OffGrid Nomads	Steering Dampers/ Steering Stabilizer/ Cab Shock	Fleetline/ Gas SLX	Classic/ Ultra/ ProGuard/ Guardian	Max Control/ LTV Severe Duty/ Load Carrier/ HiJackers/ OffGrid Nomads	Steering Dampers/ Steering Stabilizer/ Cab Shock

ITASCA

ITASCA



CLASS A MOTORHOMES (cont)

04-06	Horizon Series MotorHomes with Freightliner XC Chassis ZF - IFS Front Suspension with 23,000 lb GVW or Greater	16-18103-000 481700000493	 T	85900
02-06	Meridian Series MotorHomes with Freightliner XC Chassis ADL200 Suspension w/ 20K Rear	16-16873-000	 O	85029
	Meridian Series MotorHomes with Freightliner XC Chassis AS120 Front Suspension	16-16874-000 16-16737-000 141700131810	 O	83160
	Meridian Series MotorHomes with Freightliner XC Chassis Rear Shock with O.E.M. Number	141700131809 16-16736-000	 O	85029
	Meridian Series MotorHomes with Freightliner XC Chassis ZF - IFS Front Suspension with 23,000 lb GVW or Greater	16-18103-000 481700000493	 T	85900
06	Ellipse Series MotorHomes with Freightliner XC Chassis ADL200 Suspension w/ 20K Rear	16-16873-000	 O	85029
	Ellipse Series MotorHomes with Freightliner XC Chassis AS120 Front Suspension	16-16874-000 16-16737-000 141700131810	 O	83160
	Ellipse Series MotorHomes with Freightliner XC Chassis Rear Shock with O.E.M. Number	141700131809 16-16736-000	 O	85029
	Ellipse Series MotorHomes with Freightliner XC Chassis ZF - IFS Front Suspension with 23,000 lb GVW or Greater	16-18103-000 481700000493	 T	85900
03-04	SunCruiser Series MotorHomes with W20 , W22, & W24 Workhorse Chassis	24-153249 F4-BE5-B492-HO W0005662 W0006254 24-186629 F4-BE5-A832-MO F4-BE5-F324-HO	 O	85125
98-02	SunCruiser Series MotorHomes with W20 , W22, & W24 Workhorse Chassis	24-186629	 O	85125

CLASS C MOTORHOMES

06-20	Cambria Series Motorhomes with Ford E450 Chassis	8C2Z-18124-D 8C24-18045-DA ASH-1154 AT-163G	 O	G63622	58622 77614
		8C24-18080-DB ASH-1136 8C2Z-18125-D AT-164G	 O	G63623	58623 77623
01-20	Spirit Series Motorhomes with Ford E450 Chassis	8C2Z-18124-D 8C24-18045-DA ASH-1154 AT-163G	 O	G63622	58622 77614
		8C24-18080-DB ASH-1136 8C2Z-18125-D AT-164G	 O	G63623	58623 77623
07-14	Impulse Series Motorhomes with Ford E450 Chassis	8C2Z-18124-D 8C24-18045-DA ASH-1154 AT-163G	 O	G63622	58622 77614
		8C24-18080-DB ASH-1136 8C2Z-18125-D AT-164G	 O	G63623	58623 77623

APPLICATION GUIDE

Year	Fitment Notes	OEM#								
			Fleetline\ Gas SLX	Classic\ Ultra\ ProGuard\ Guardian	Max Control\ LTV Severe Duty\ Load Carrier\ Hijackers\ OffGrid Nomads	Steering Dampers\ Steering Stabilizer\ Cab Shock	Fleetline\ Gas SLX	Classic\ Ultra\ ProGuard\ Guardian	Max Control\ LTV Severe Duty\ Load Carrier\ Hijackers\ OffGrid Nomads	Steering Dampers\ Steering Stabilizer\ Cab Shock

JAYCO

JAYCO

ALANTE

16-24	MotorHomes with Ford F53 Chassis with 16,000 lb GVW to 22,000 lb GVW	ASH-1229 ASH-1228 9U94-18045-AA ASH-1205 AT-620 ASH-1022 1C34-18045-AA ASH-294 9U9Z-18124-A ASH-25822 ASH-25823 1C34-18045-JA AT-766	83209
		ASH-1206 9U94-18080-AA AT-621 ASH-25824 9U9Z-18125-A ASH-1023 ASH-1230 ASH-137	83122 89406

CLASS A MOTORHOMES

15-20	Alante Series MotorHomes with Ford F53 Chassis with 16,000 lb GVW to 22,000 lb GVW	ASH-1229 ASH-25822 ASH-25823	89414
		ASH-25824	89406
14-20	Precept Series MotorHomes with Ford F53 Chassis with 16,000 lb GVW to 22,000 lb GVW	ASH-1229 ASH-25822 ASH-25823	89414
		ASH-25824	89406

ESCAPADE

03-06	MotorHomes with Ford E350 or E450 Chassis	8C2Z-18124-D 8C24-18045-DA ASH-1154 AT-163G	...	G63622	58622 77614
		8C24-18080-DB ASH-1136 8C2Z-18125-D AT-164G	G63623	58623 77623



GRANITE RIDGE

02-06	MotorHomes with Ford E350 or E450 Chassis	8C2Z-18124-D 8C24-18045-DA ASH-1154 AT-163G	...	G63622	58622 77614
		8C24-18080-DB ASH-1136 8C2Z-18125-D AT-164G	G63623	58623 77623

GREYHAWK

25-26	29MV, Motorhomes with Ford E450 Chassis	8C2Z-18125-D	61646
			77623
26	29MV, Motorhomes with Ford E450 Chassis 29MV, With Ford E-450 Super Duty	8C2Z-18124-D	77614
		8C2Z-18125-D	...	G63622	58622	...	G63623	58623
02-24	MotorHomes with Ford E450 Chassis	8C2Z-18124-D 8C24-18045-DA ASH-1154 AT-163G	...	G63622	58622 77614
		8C24-18080-DB ASH-1136 8C2Z-18125-D AT-164G	G63623	58623 77623

APPLICATION GUIDE

Year	Fitment Notes	OEM#								
			Fleetline\ Gas SLX	Classic\ Ultra\ ProGuard\ Guardian	Max Control\ LTV Severe Duty\ Load Carrier\ HiJackers\ OffGrid Nomads	Steering Dampers\ Steering Stabilizer\ Cab Shock	Fleetline\ Gas SLX	Classic\ Ultra\ ProGuard\ Guardian	Max Control\ LTV Severe Duty\ Load Carrier\ HiJackers\ OffGrid Nomads	Steering Dampers\ Steering Stabilizer\ Cab Shock

JAYCO

JAYCO

MELBOURNE

07-24	MotorHomes with Ford E350 or E450 Chassis	8C2Z-18124-D 8C24-18045-DA ASH-1154 AT-163G	I O		G63622	58622 77614				
		8C24-18080-DB ASH-1136 8C2Z-18125-D AT-164G	I O						G63623	58623 77623

PRECEPT

14-24	MotorHomes with Ford F53 Chassis with 16,000 lb GVW to 22,000 lb GVW	ASH-1229 ASH-1228 9U94-18045-AA ASH-1205 AT-620 ASH-1022 1C34-18045-AA ASH-294 9U9Z-18124-A ASH-25822 ASH-25823 1C34-18045-JA AT-766	O O	83209						
		ASH-1206 9U94-18080-AA AT-621 ASH-25824 9U9Z-18125-A ASH-1023 ASH-1230 ASH-137	O O							83122 89406

REDHAWK

13-24	MotorHomes with Ford E450 Chassis	8C2Z-18124-D 8C24-18045-DA ASH-1154 AT-163G	I O		G63622	58622 77614				
		8C24-18080-DB ASH-1136 8C2Z-18125-D AT-164G	I O						G63623	58623 77623

REDHAWK 30Z

25	Motorhomes with Ford E450 Chassis	8C2Z-18124-D	I O			77614					
		8C2Z-18125-D	I O						61646	77623	
	With Ford E-450 Super Duty	8C2Z-18124-D	I O			G63622	58622				
		8C2Z-18125-D	I O						G63623	58623	



REDHAWK 31FF

25-26	Motorhomes with Ford E450 Chassis	8C2Z-18124-D	I O			77614				
26	Motorhomes with Ford E450 Chassis	8C2Z-18125-D	I O						61646	77623
		8C2Z-18124-D	I O			G63622	58622			
	8C2Z-18125-D	I O							G63623	58623
25	Motorhomes with Ford E450 Chassis	8C2Z-18125-D	I O						61646	

REDHAWK SE

25-26	Motorhomes with Ford E350 Chassis	8C2Z-18125-D	I O						61646	77623
26	Motorhomes with Ford E350 Chassis	8C2Z-18124-D	I O			77614				
		MotorHomes with Ford E450 Chassis	I O			77614				
	With Ford E-350 Super Duty	8C2Z-18124-D	I O			G63622	58622			

APPLICATION GUIDE

Year	Fitment Notes	OEM#								
			Fleetline\ Gas SLX	Classic\ Ultra\ ProGuard\ Guardian	Max Control\ LTV Severe Duty\ Load Carrier\ Hijackers\ OffGrid Nomads	Steering Dampers\ Steering Stabilizer\ Cab Shock	Fleetline\ Gas SLX	Classic\ Ultra\ ProGuard\ Guardian	Max Control\ LTV Severe Duty\ Load Carrier\ Hijackers\ OffGrid Nomads	Steering Dampers\ Steering Stabilizer\ Cab Shock

JAYCO

JAYCO

REDHAWK SE (cont)

26	With Ford E-350 Super Duty	8C2Z-18125-D		G63623	58623
25	MotorHomes with Ford E450 Chassis	8C2Z-18124-D 8C24-18045-DA ASH-1154 AT-163G		77614
18-24	MotorHomes with Ford E450 Chassis	8C2Z-18124-D 8C24-18045-DA ASH-1154 AT-163G		G63622	58622 77614	
		8C24-18080-DB ASH-1136 8C2Z-18125-D AT-164G		G63623	58623 77623

SENECA

18-24	Models with Freightliner S2RV chassis	10-13976-000		85918
		16-16764-000			85724 89443

SENECA PRESTIGE

21-24	Models with Freightliner S2RV chassis	10-13976-000		85918
21-23	Models with Freightliner S2RV chassis	16-16764-000			85724 89443

KENWORTH

KENWORTH



K270

13-24	Models with 10,000 lb to 12,000 lb Front Axle	1707378PAC BFRG 072		85182
	Models with Hendrickson HAS - 210L or HAS - 230L Rear Air Suspension	60670-008 60670-008L			83123 89405
	Models with Hendrickson HAS - 230 Rear Air Suspension	60670-005 60670-005PLUS-2 60670-005L			83137
	Models with Reyco 102 or 79KB Suspension (Drive Axle)	19495-01 16725-01			83126 89430

K300

93-05	All with Air Glide 100 Suspension with 8 air bags, 4 units required	K374-29 K374-32			85310 89423
	All with Air Glide 200 with 40,000 lb Suspension with 8 air bags, 4 units required	665903 70701 665944			85900
	All with Air Glide 200 with 46,000 lb Suspension with 8 air bags, 4 units required	665945 665906			85902
	K300 COE Medium Duty	665565		85007
	Models with 12,000 lb Taper Leaf Front Springs (5/8" Top Mounting bolt)	665617 B71-1000		85031
	Models with Hendrickson Rear Air Suspension	47902-19			83123 89405
	Models with Multiple Leaf Springs on Front Axle (3/4" Mounting bolts)	B71-1003 K374-33 K374-3		83312
	Models with Reyco 102 or 79KB Suspension (Drive Axle)	19495-01 16725-01			83126 89430
	Models with Reyco 1209 or 1212 Suspension (Steer Axle)	19495-01		83126
	Models with Taper Leaf Springs on Front Axle (1" Mounting bolts)	B71-1002 K374-16 K374-27 K374-26		85001
	Models with Woodhead Shock (Stamping Number ACHB 966)	ACHB966			83136

APPLICATION GUIDE

Year	Fitment Notes	OEM#								
			Fleetline/ Gas SLX	Classic/ Ultra/ ProGuard/ Guardian	Max Control/ LTV Severe Duty/ Load Carrier/ HiJackers/ OffGrid Nomads	Steering Dampers/ Steering Stabilizer/ Cab Shock	Fleetline/ Gas SLX	Classic/ Ultra/ ProGuard/ Guardian	Max Control/ LTV Severe Duty/ Load Carrier/ HiJackers/ OffGrid Nomads	Steering Dampers/ Steering Stabilizer/ Cab Shock

KENWORTH

T170

08-22	Models with Reyco 79KB Rear Steel Spring Suspension	19495-01 16725-01	O O	83126 89430
08-21	Models with 8,000 lb Taper Leaf Front Springs	665617	O	85031

KENWORTH

T270

24	Models with AG210L Rear Air Suspension	C71-1017 C71-1011	I T	85069
20-23	Models with Air Glide 400L (AG400L) Rear Air Suspension	C71-1017	I T	85069
08-23	Models with AG210L Rear Air Suspension	C71-1017 C71-1011	I T	85069 89455
	Models with Hendrickson HAS - 210L or HAS - 230L Rear Air Suspension	60670-008 60670-008L	O O	83123 89405
	Models with Hendrickson HMX 400/460 Haulmax with 16.5" Saddle	60680-004L 60680-004 64178-001	O T	83143
15-22	Models with 10,000 lb to 14,600 lb Taperleaf Springs and Set Back Front Axles	B71-6019	O O	85989
	Models with 16,000 lb to 20,000 lb Taperleaf Springs and Set Back Front Axles	B71-6020	O O	85989
08-22	Models with Hendrickson Primaax 230, 232, 460, 462, 690 and 692 Air Suspension (8-1/2" to 10" Ride Height)	60657-003 60657-003L	O O	85072
10-14	Models with 10,000 lb to 12,000 lb Front Axle	B71-6005	O O	85084
	Models with 13,200 lb to 14,600 lb Front Axle	B71-6006	O O	85084
	Models with 8,000 lb Front Axle	B71-6004	O O	85084
08-14	Models with Hendrickson HAS - 400 (Standard) Rear Air Suspension	60670-005 60670-005L	O O	83137
08-10	Models with 12,000 lb Front Axle	665617	O O	85031



T280

21-24	Models with Reyco 102 or 79KB Suspension (Drive Axle)	19495-01	O O	83126 89430
24	Models with 10,000 lb to 12,000 lb Mono-leaf front springs	B71-6019	O O	85989

T300

	All with Air Glide 100 Suspension with 8 air bags, 4 units required	K374-29 K374-32	I T	85310 89423
	All with Air Glide 200 with 40,000 lb Suspension with 8 air bags, 4 units required	665903 70701 665944	I T	85900
	Models with Hendrickson Rear Air Suspension	60670-004	O O	83123 89405
	Models with Multiple Leaf Springs on Front Axle (3/4" Mounting bolts)	B71-1003 K374-33 K374-3	O	83312
	Models with Reyco 102 or 79KB Suspension (Drive Axle) To 2022	19495-01 16725-01	O O	83126 89430
	Models with Reyco 1209 or 1212 Suspension (Steer Axle) To 2022	19495-01	O	83126
	Models with Taper Leaf Springs on Front Axle (1" Mounting bolts)	B71-1002 K374-16 K374-27 K374-26	O	85001
	Models with Woodhead Shock (Stamping Number ACHB 966)	ACHB966	I T	83136

APPLICATION GUIDE

Year	Fitment Notes	OEM#								
			Fleetline\ Gas SLX	Classic\ Ultra\ ProGuard\ Guardian	Max Control\ LTV Severe Duty\ Load Carrier\ Hijackers\ OffGrid Nomads	Steering Dampers\ Steering Stabilizer\ Cab Shock	Fleetline\ Gas SLX	Classic\ Ultra\ ProGuard\ Guardian	Max Control\ LTV Severe Duty\ Load Carrier\ Hijackers\ OffGrid Nomads	Steering Dampers\ Steering Stabilizer\ Cab Shock

KENWORTH

KENWORTH

T300 (cont)

99-08	Models with 12,000 lb Taper Leaf Front Springs (5/8" Top Mounting bolt)	665617 B71-1000	010	85031
	Models with Reyco 102 or 79KB Suspension (Drive Axle)	19495-01 16725-01	010	83126 89430
	Models with Reyco 1209 or 1212 Suspension (Steer Axle)	19495-01	010	83126 89430
95-08	All with Air Glide 200 with 46,000 lb Suspension with 8 air bags, 4 units required	665945 665906	010	85902
	Models with Hendrickson HAS - 210L or HAS - 230L Rear Air Suspension	60670-008 60670-008L	010	83123 89405

KING OF THE ROAD

KING OF THE ROAD

CLASS A MOTORHOMES

04-06	Genesis Series MotorHomes with Freightliner XC Chassis ADL200 Suspension w/ 20K Rear	16-16873-000	010	85029
	Genesis Series MotorHomes with Freightliner XC Chassis AS120 Front Suspension	16-16874-000 16-16737-000 141700131810	010	83160
	Genesis Series MotorHomes with Freightliner XC Chassis Rear Shock with O.E.M. Number	141700131809 16-16736-000	010	85029
	Genesis Series MotorHomes with Freightliner XC Chassis ZF - IFS Front Suspension with 23,000 lb GVW or Greater	16-18103-000 481700000493	010	85900

KRYSTAL BUS

KRYSTAL BUS

VARIOUS

	Krystal E-450 Shuttle bus To 2020	ASH-1154	010	G63622	58622 77614
		ASH-1136	010	G63623	58623 77623

LEISURE TRAVEL

LEISURE TRAVEL

WONDER

19-22	MotorHomes with Ford Transit-350 Chassis		010	G57816 ⁴⁰	G64177
-------	--	--	-----	------	----------------------	------	------	------	------	--------	------	------

LGE COACHWORKS

LGE COACHWORKS

VARIOUS

	All Shuttle buses with Ford E350 and E450 Chassis To 2020	ASH-1136	010	G63623	58623 77623
	All Shuttle buses with Ford E350 and E450 Chassis To 2022	ASH-1154	010	G63622	58622 77614

LION

LION

LION6

21-22	Models with Hendrickson Comfort Air Suspension (21K Capacity)	60670-030L 60670-030	010	83166
	Trucks with Hendrickson Softek Suspension (12,500 lb Capacity)	58913-010L 58913-010	010	85106



MACK

MACK

MD6

24	Models with 10,000 lb Taperleaf Springs	78530771 471700015341	010	83127
----	---	--------------------------	-----	-------	------	------	------	------	------	------	------	------

APPLICATION GUIDE

Year	Fitment Notes	OEM#								
			Fleetline\ Gas SLX	Classic\ Ultra\ ProGuard\ Guardian	Max Control\ LTV Severe Duty\ Load Carrier\ HiJackers\ OffGrid Nomads	Steering Dampers\ Steering Stabilizer\ Cab Shock	Fleetline\ Gas SLX	Classic\ Ultra\ ProGuard\ Guardian	Max Control\ LTV Severe Duty\ Load Carrier\ HiJackers\ OffGrid Nomads	Steering Dampers\ Steering Stabilizer\ Cab Shock

MACK

MACK

MD6 (cont)

24	Models with O.E.M. Number	23145372	O	83066
		23159760	O	85188
23	Models with 10,000 lb Taperleaf Springs	78530771 471700015341	O	83127
	Models with O.E.M. Number	23159760	O	85188
		23145372	O	83066
21-22	Models with 10,000 lb Taperleaf Springs	78530771 471700015341	O	83127
	Models with O.E.M. Number	23145372	O	83066
		23159760	O	85188

MANDALAY COACH

MANDALAY COACH

CLASS A MOTORHOMES

04-06	Mandalay Series MotorHomes with Freightliner XC Chassis ADL200 Suspension w/ 20K Rear	16-16873-000	O	85029
	Mandalay Series MotorHomes with Freightliner XC Chassis AS120 Front Suspension	16-16874-000 16-16737-000 141700131810	O	83160
	Mandalay Series MotorHomes with Freightliner XC Chassis Rear Shock with O.E.M. Number	141700131809 16-16736-000	O	85029
	Mandalay Series MotorHomes with Freightliner XC Chassis ZF - IFS Front Suspension with 23,000 lb GVW or Greater	16-18103-000 481700000493	I	85900
06	Presidio & Valencia Series MotorHomes with Freightliner XC Chassis AS120 Front Suspension	16-16874-000 16-16737-000 141700131810	O	83160
	Presidio & Valencia Series MotorHomes with Freightliner XC Chassis Rear Shock with O.E.M. Number	141700131809 16-16736-000	O	85029
	Presidio & Valencia Series MotorHomes with Freightliner XC Chassis ZF - IFS Front Suspension with 23,000 lb GVW or Greater	16-18103-000 481700000493	I	85900

MARMON HERRINGTON

MARMON HERRINGTON

57 GLIDER

96-97	Conventional Tractors with Link Cabmate Model MARC57-B	1201-0054 1202-0054	O	83021
90-94	Conventional Tractors with Link Cabmate Model MARC57-B	1201-0054 1202-0054	O	83021

MITSUBISHI

MITSUBISHI

CANTER 35

00-01	With OEM Number	MB025382 MB025381	I	83114
-------	-----------------	----------------------	---	-------	------	------	------	------	------	------	------

CANTER 55

00-05	With OEM Number	MB025382 MB025381	I	83114
-------	-----------------	----------------------	---	-------	------	------	------	------	------	------	------



CANTER 60

01-05	With OEM Number	MB025382 MB025381	I	83114
-------	-----------------	----------------------	---	-------	------	------	------	------	------	------	------

CANTER 75

01-05	With OEM Number	MB025382 MB025381	I	83114
-------	-----------------	----------------------	---	-------	------	------	------	------	------	------	------

APPLICATION GUIDE

Year	Fitment Notes	OEM#								
			Fleetline\ Gas SLX	Classic\ Ultra\ ProGuard\ Guardian	Max Control\ LTV Severe Duty\ Load Carrier\ Hijackers\ OffGrid Nomads	Steering Dampers\ Steering Stabilizer\ Cab Shock	Fleetline\ Gas SLX	Classic\ Ultra\ ProGuard\ Guardian	Max Control\ LTV Severe Duty\ Load Carrier\ Hijackers\ OffGrid Nomads	Steering Dampers\ Steering Stabilizer\ Cab Shock

MITSUBISHI

MITSUBISHI

CANTER FB SERIES

01-10	Series FB7; FB8 With OEM Number	MB025382 MB025381	 O	83114				
-------	---------------------------------	----------------------	-------	-------	------	------	------	--	--	--	--

CANTER FE SERIES

93-95	Series FE339 With OEM Number	MB025382 MB025381	 O	83114				
90-95	Series FE334; FE449 With OEM Number	MB025382 MB025381	 O	83114				
86-95	Series FE434; FE439; FE444 With OEM Number	MB025382 MB025381	 O	83114				

CANTER FE516BC

93-99	With OEM Number	MC809390		 I	83103			
-------	-----------------	----------	--	------	------	------	------	-------	-------	--	--	--

CANTER FH100

90-95	With OEM Number	MB025382 MB025381	 O	83114					
88-95	With OEM Number	MC809390		 I	83103			

CANTER FK SERIES

03-08	Series FK61F With OEM Number	MB025382 MB025381	 O	83114				
95-08	Series FK617 With OEM Number	MB025382 MB025381	 O	83114				
01-03	Series FK618 With OEM Number	MB025382 MB025381	 O	83114				
00	Series FK618 With OEM Number	MB02538 MB025382	 O	83114				
96-99	Series FK618 With OEM Number	MB025382 MB025381	 O	83114				
89-95	Series FK417 With OEM Number	MB025382 MB025381	 O	83114				
95	Series FK618 With OEM Number	MB02538 MB025382	 O	83114				
87-91	Series FK415 With OEM Number	MB025382 MB025381	 O	83114				
82-84	Series FK115 With OEM Number	MB025382 MB025381	 O	83114				
76-84	Series FK102 With OEM Number	MB025382 MB025381	 O	83114				

CANTER FM SERIES

76-84	Series FM215 With OEM Number	MB025382 MB025381	 O	83114				
-------	------------------------------	----------------------	-------	-------	------	------	------	--	--	--	--

CANTER FN SERIES

03-08	Series FN61F With OEM Number	MB025382 MB025381	 O	83114				
-------	------------------------------	----------------------	-------	-------	------	------	------	--	--	--	--



FIGHTER FM SERIES

07-15	Series FM65F With OEM Number	MC091947	 O	83515				
99-06	Series FM657M With OEM Number	MC091947	 O	83515				

ROSA

05	BE64DG Series; With OEM Number	MC189924 MB161741		 O		G63405		
97-99	BE632 Series; With OEM Number	MC189924 MB161741		 O		G63405		
99	FE63E Series; With OEM Number	MC189924 MB161741		 O		G63405		
97	BE637 Series; With OEM Number	MC189924 MB161741		 O		G63405		

APPLICATION GUIDE

Year	Fitment Notes	OEM#								
			Fleetline\ Gas SLX	Classic\ Ultra\ ProGuard	Max Control\ LTV Severe Duty\ Load Carrier\ HiJackers\ OffGrid Nomads	Steering Dampers\ Steering Stabilizer\ Cab Shock	Fleetline\ Gas SLX	Classic\ Ultra\ ProGuard	Max Control\ LTV Severe Duty\ Load Carrier\ HiJackers\ OffGrid Nomads	Steering Dampers\ Steering Stabilizer\ Cab Shock

MITSUBISHI CANTER

MITSUBISHI CANTER

35

00-01	With OEM Number	MK433624 MK433614 MK433615 MC114594 MK383775 MB161497	OIO	G63299
-------	-----------------	--	-------	-------	-------	-------	-----	-------	--------	-------	-------

55

00-05	With OEM Number	MK433624 MK433614 MK433615 MC114594 MK383775 MB161497	OIO	G63299
-------	-----------------	--	-------	-------	-------	-------	-----	-------	--------	-------	-------

60

01-05	With OEM Number	MK433624 MK433614 MK433615 MC114594 MK383775 MB161497	OIO	G63299
-------	-----------------	--	-------	-------	-------	-------	-----	-------	--------	-------	-------

75

01-05	With OEM Number	MK433624 MK433614 MK433615 MC114594 MK383775 MB161497	OIO	G63299
-------	-----------------	--	-------	-------	-------	-------	-----	-------	--------	-------	-------



FB SERIES

10-19	FBA30 Series With OEM Number	MK433624 MK433614 MK433615 MC114594 MK383775 MB161497	OIO	G63299
01-10	FB7 & FB8 Series With OEM Number	MK433624 MK433614 MK433615 MC114594 MK383775 MB161497	OIO	G63299
93-99	FB501B Series With OEM Number	MK433624 MK433614 MK433615 MC114594 MK383775 MB161497	OIO	G63299

FE SERIES

10-20	FE85O Series; With OEM Number	MK433624 MK433614 MK433615 MC114594 MK383775 MB161497	OIO	G63299
07-19	FE71C Series; With OEM Number	MK433624 MK433614 MK433615 MC114594 MK383775 MB161497	OIO	G63299
07-13	FE83B & FE84B EU Series; With OEM Number	MK433624 MK433614 MK433615 MC114594 MK383775 MB161497	OIO	G63299
	FE85B Series; With OEM Number	MK433624 MK433614 MK433615 MC114594 MK383775 MB161497	OIO	G63299

APPLICATION GUIDE



Year	Fitment Notes	OEM#								
			Fleetline/ Gas SLX	Classic/ Ultra/ ProGuard/ Guardian	Max Control/ LTV Severe Duty/ Load Carrier/ HiJackers/ OffGrid Nomads	Steering Dampers/ Steering Stabilizer/ Cab Shock	Fleetline/ Gas SLX	Classic/ Ultra/ ProGuard/ Guardian	Max Control/ LTV Severe Duty/ Load Carrier/ HiJackers/ OffGrid Nomads	Steering Dampers/ Steering Stabilizer/ Cab Shock

MITSUBISHI CANTER FE SERIES (cont)

MITSUBISHI CANTER

05-13	FE85P Series; With OEM Number	MK433624 MK433614 MK433615 MC114594 MK383775 MB161497	o	o	o	o	o	o	o	o	o	o	o
04-13	FE73D Series; With OEM Number	MK433624 MK433614 MK433615 MC114594 MK383775 MB161497	o	o	o	o	o	o	o	o	o	o	o
	FE84B & FE84BV Series; With OEM Number	MK433624 MK433614 MK433615 MC114594 MK383775 MB161497	o	o	o	o	o	o	o	o	o	o	o
	FE; With OEM Number	MC114595	o	o	G63405	o	o	o	o	o	o	o	o
13	FE84C & FE84C EU Series; With OEM Number	MK433624 MK433614 MK433615 MC114594 MK383775 MB161497	o	o	o	o	o	o	o	o	o	o	o
04-11	FE74B Series; With OEM Number	MK433624 MK433614 MK433615 MC114594 MK383775 MB161497	o	o	o	o	o	o	o	o	o	o	o
02-11	FE83C Series; With OEM Number	MK433624 MK433614 MK433615 MC114594 MK383775 MB161497	o	o	o	o	o	o	o	o	o	o	o
99-11	FE637 AUS Series; With OEM Number	MK433624 MK433614 MK433615 MC114594 MK383775 MB161497	o	o	o	o	o	o	o	o	o	o	o
04-09	FE72D Series; With OEM Number	MK433624 MK433614 MK433615 MC114594 MK383775 MB161497	o	o	o	o	o	o	o	o	o	o	o
09	FE85S Series; With OEM Number	MK433624 MK433614 MK433615 MC114594 MK383775 MB161497	o	o	o	o	o	o	o	o	o	o	o
04-08	FE84P Series; With OEM Number	MK433624 MK433614 MK433615 MC114594 MK383775 MB161497	o	o	o	o	o	o	o	o	o	o	o
04-07	FE84P LHD Series; With OEM Number	MK433624 MK433614 MK433615 MC114594 MK383775 MB161497	o	o	o	o	o	o	o	o	o	o	o
02-04	FE72E & FE73E Series; With OEM Number	MK433624 MK433614 MK433615 MC114594 MK383775 MB161497	o	o	o	o	o	o	o	o	o	o	o

APPLICATION GUIDE



Year	Fitment Notes	OEM#								
			Fleetline\ Gas SLX	Classic\ Ultra\ ProGuard\ Guardian	Max Control\ LTV Severe Duty\ Load Carrier\ HiJackers\ OffGrid Nomads	Steering Dampers\ Steering Stabilizer\ Cab Shock	Fleetline\ Gas SLX	Classic\ Ultra\ ProGuard\ Guardian	Max Control\ LTV Severe Duty\ Load Carrier\ HiJackers\ OffGrid Nomads	Steering Dampers\ Steering Stabilizer\ Cab Shock

MITSUBISHI CANTER FE SERIES (cont)

MITSUBISHI CANTER

02-04	FE82E & FE83E Series; With OEM Number	MK433624 MK433614 MK433615 MC114594 MK383775 MB161497	OIO	G63299
94-04	FE649 Series; With OEM Number	MK433624 MK433614 MK433615 MC114594 MK383775 MB161497	OIO	G63299
99-02	FE53EB & FE53EC Series; With OEM Number	MK433624 MK433614 MK433615 MC114594 MK383775 MB161497	OIO	G63299
	FE53EEV, FE53EEX & FE53EEX Series; With OEM Number	MK433624 MK433614 MK433615 MC114594 MK383775 MB161497	OIO	G63299
	FE63E Series; With OEM Number	MK433624 MK433614 MK433615 MC114594 MK383775 MB161497	OIO	G63299
98-02	FE639 LHD Series; With OEM Number	MK433624 MK433614 MK433615 MC114594 MK383775 MB161497	OIO	G63299
97-02	FE562 Series; With OEM Number	MK433624 MK433614 MK433615 MC114594 MK383775 MB161497	OIO	G63299
97-99	FE51EB Series; With OEM Number	MK433624 MK433614 MK433615 MC114594 MK383775 MB161497	OIO	G63299
93-99	FE516BC & FE517BD Series; With OEM Number	MK433624 MK433614 MK433615 MC114594 MK383775 MB161497	OIO	G63299
	FE537 Series; With OEM Number	MK433624 MK433614 MK433615 MC114594 MK383775 MB161497	OIO	G63299
	FE538E Series; With OEM Number	MK433624 MK433614 MK433615 MC114594 MK383775 MB161497	OIO	G63299
	FE638 & FE639 Series; With OEM Number	MK433624 MK433614 MK433615 MC114594 MK383775 MB161497	OIO	G63299
89-97	FE335EV Series; With OEM Number	MK433624 MK433614 MK433615 MC114594 MK383775 MB161497	OIO	G63299

APPLICATION GUIDE

Year	Fitment Notes	OEM#								
			Fleetline\ Gas SLX	Classic\ Ultra\ ProGuard\ Guardian	Max Control\ LTV Severe Duty\ Load Carrier\ Hijackers\ OffGrid Nomads	Steering Dampers\ Steering Stabilizer\ Cab Shock	Fleetline\ Gas SLX	Classic\ Ultra\ ProGuard\ Guardian	Max Control\ LTV Severe Duty\ Load Carrier\ Hijackers\ OffGrid Nomads	Steering Dampers\ Steering Stabilizer\ Cab Shock

MITSUBISHI CANTER FE SERIES (cont)

MITSUBISHI CANTER

85-97	FE305 Series; With OEM Number	MK433624 MK433614 MK433615 MC114594 MK383775 MB161497										
84-95	FE; With OEM Number	MC114595										
	With OEM Number	MK433624 MK433614 MK433615 MC114594 MK383775 MB161497										
95	FE659F Series; With OEM Number	MK433624 MK433614 MK433615 MC114594 MK383775 MB161497										
92-93	FE337EV Series; With OEM Number	MK433624 MK433614 MK433615 MC114594 MK383775 MB161497										
85-89	FE435 Series; With OEM Number	MK433624 MK433614 MK433615 MC114594 MK383775 MB161497										



MITSUBISHI FUSO

MITSUBISHI FUSO

FE

07-13	FEFE84B EU LHD Series; Model with O.E.M. Number	MK433624 MK433614 MK433615 MC114594 MK383775 MB161497										
13	FE84C EU LHD Series; Model with O.E.M. Number	MK433624 MK433614 MK433615 MC114594 MK383775 MB161497										
05-10	FE7 & FE8 Series; Model with O.E.M. Number	MK433624 MK433614 MK433615 MC114594 MK383775 MB161497										
01-04	FE7 & FE8 Series; Model with O.E.M. Number	MK433624 MK433614 MK433615 MC114594 MK383775 MB161497										
96-04	Model with O.E.M Number											
	Model with O.E.M. Number	MC114595										
	Models with O.E.M. Number	MK433638 MA302296										
87-04	Model with O.E.M. Number	MB161497										
96-99	With OEM Number	MC114595										
89-97	FE335EV Series; Model with O.E.M. Number	MK433615										

APPLICATION GUIDE

Year	Fitment Notes	OEM#								
			Fleetline/ Gas SLX	Classic/ Ultra/ ProGuard/ Guardian	Max Control/ LTV Severe Duty/ Load Carrier/ HiJackers/ OffGrid Nomads	Steering Dampers/ Steering Stabilizer/ Cab Shock	Fleetline/ Gas SLX	Classic/ Ultra/ ProGuard/ Guardian	Max Control/ LTV Severe Duty/ Load Carrier/ HiJackers/ OffGrid Nomads	Steering Dampers/ Steering Stabilizer/ Cab Shock

MITSUBISHI FUSO

FE (cont)

92-93	FE337EV Series; Model with O.E.M. Number	MK433624 MK433614 MK433615 MC114594 MK383775 MB161497		83114	G63299
87-89	FE435 Series; Model with O.E.M. Number	MK433624 MK433614 MK433615 MC114594 MK383775 MB161497		G63299
85-86	FE435 Series; Model with O.E.M. Number	MK433624 MK433614 MK433615 MC114594 MK383775 MB161497		G63299

MITSUBISHI FUSO

FE SERIES

01-10	FE7 & FE8 with OE Number	MB025382 MB025381		83114
06	With OEM Number	MC114595		G63405

FE145

05-11	Models with O.E.M. Number	MK433638 MK302296		G63610
-------	---------------------------	----------------------	--	------	--------	------	------	--	------	------	------	------

FG

98-04	Model with O.E.M Number			77907
	Model with O.E.M. Number	MC714595		G63405
00-02	With OEM Number	MC114595		G63405
91	FG434, With OEM Number	MC189924 MB161741		G63405

FG SERIES

89-97	FG439 Series; With OEM Number	MC189924 MB161741		G63405
96	FG639 Series; With OEM Number	MC189924 MB161741		G63405
95	FG637 Series; With OEM Number	MC189924 MB161741		G63405

FH

88-04	Models with O.E.M. Number	MC826268		G63610
88-96	Models with O.E.M. Number	MC809390			83103

FK

91-95	FK455 Models with 19mm Lower Mounting Pin, with OEM Number	MC814614		85009
	FK457 Models with 19mm Lower Mounting Pin, with OEM Number	MC814614		85009
87-95	FK415 Models with 19mm Lower Mounting Pin, with OEM Number	MC814614		85009
95	FK190: 19mm Lower Mounting Pin, with OEM Number	MC814614		85009
88-90	FK455 Models with O.E.M. Number	MC814614		85009

FM

89-93	FM557 Models with O.E.M. Number	MC814614		85009
86-88	Model with O.E.M. Number	MC813135		89447
	Models with O.E.M. Number	MC813135		83456

APPLICATION GUIDE

Year	Fitment Notes	OEM#								
			Fleetline\ Gas SLX	Classic\ Ultra\ ProGuard\ Guardian	Max Control\ LTV Severe Duty\ Load Carrier\ Hijackers\ OffGrid Nomads	Steering Dampers\ Steering Stabilizer\ Cab Shock	Fleetline\ Gas SLX	Classic\ Ultra\ ProGuard\ Guardian	Max Control\ LTV Severe Duty\ Load Carrier\ Hijackers\ OffGrid Nomads	Steering Dampers\ Steering Stabilizer\ Cab Shock

MITSUBISHI FUSO

FM (cont)

88	FM555 Models with O.E.M. Number	MC814614		85009
87	FM557 Models with O.E.M. Number	MC814614		85009
86	FM555 Models with O.E.M. Number	MC814614		85009

MITSUBISHI FUSO

FP SERIES

96-01	FP417 Series With OEM Number	MC035111			85711
88-01	FP415 Series With OEM Number	MC035111			85711
	FP418 Series With OEM Number	MC035111			85711
	FP418 Series; With OEM Number	MK433624 MK433614 MK433615 MC114594 MK383775 MB161497	G63299
01	All	MK433624 MK433614 MK433615 MC114594 MK383775 MB161497		G63299
	FP435 Series; With OEM Number	MK433624 MK433614 MK433615 MC114594 MK383775 MB161497		G63299
80-96	With OEM Number	MK433624 MK433614 MK433615 MC114594 MK383775 MB161497		G63299
83-89	All	MK433615		G63299
	FP413J Series; With OEM	MK433615 MB161497		G63299
	FP413J Series; With OEM Number	MK433624 MK433614 MC114594 MK383775		G63299
	FP418 Series; With OEM	MB161497		G63299

MITSUBISHI FUSO BUS

BE637

14-21	With OEM Number	MC189924 MB161741		G63405
-------	-----------------	----------------------	--	------	------	------	------	--	------	--------	------	------

MITSUBISHI FUSO BUS



MONACO COACH

CLASS A MOTORHOMES

	Models with Workhorse UFO Chassis with Hendrickson Softek Front Suspension	66153-002 F4-BE5-C832-MO		83124
98-11	All Models with W20 & W22 Workhorse Motorhome Chassis	24-153249 F4-BE5-B492-HO W0006254 W0006254 24153249 24-186629 F4-BE5-A832-MO F4-BE5-F324-HO		85125
04-07	Models with Roadmaster Chassis R4R, used on Cayman		83144
00-03	Models with Roadmaster Chassis RM4C or used on Knight	01809924		83144

MONACO COACH

APPLICATION GUIDE

Year	Fitment Notes	OEM#								
			Fleetline\ Gas SLX	Classic\ Ultra\ ProGuard\ Guardian	Max Control\ LTV Severe Duty\ Load Carrier\ HiJackers\ OffGrid Nomads	Steering Dampers\ Steering Stabilizer\ Cab Shock	Fleetline\ Gas SLX	Classic\ Ultra\ ProGuard\ Guardian	Max Control\ LTV Severe Duty\ Load Carrier\ HiJackers\ OffGrid Nomads	Steering Dampers\ Steering Stabilizer\ Cab Shock

MONACO COACH

MONACO COACH

CLASS A MOTORHOMES (cont)

00-03	Models with Workhorse W22 Chassis with 8.1L Gas Monarch, LaPalma	01809925	O/O	85010
-------	--	----------	-----	-------	------	------	------	------	------	------	------

LA PALMA

07-08	MotorHomes with Ford F53 Chassis with 16,000 lb GVW to 22,000 lb GVW	ASH-1229 ASH-1228 9U94-18045-AA ASH-1205 AT-620 ASH-1022 1C34-18045-AA ASH-294 9U9Z-18124-A ASH-25822 ASH-25823 1C34-18045-JA AT-766	O/O	83209
01	MotorHomes with Ford F53 Chassis with 16,000 lb GVW to 22,000 lb GVW	ASH-1229 ASH-1228 9U94-18045-AA ASH-1205 AT-620 ASH-1022 1C34-18045-AA ASH-294 9U9Z-18124-A ASH-25822 ASH-25823 1C34-18045-JA AT-766	O/O	83209
90-99	MotorHomes with Ford F53 Chassis with 16,000 lb GVW to 22,000 lb GVW	ASH-1229 ASH-1228 9U94-18045-AA ASH-1205 AT-620 ASH-1022 1C34-18045-AA ASH-294 9U9Z-18124-A ASH-25822 ASH-25823 1C34-18045-JA AT-766	O/O	83209



MONARCH

03-05	MotorHomes with Ford F53 Chassis with 16,000 lb GVW to 22,000 lb GVW	ASH-1229 ASH-1228 9U94-18045-AA ASH-1205 AT-620 ASH-1022 1C34-18045-AA ASH-294 9U9Z-18124-A ASH-25822 ASH-25823 1C34-18045-JA AT-766	O/O	83209
90-99	MotorHomes with Ford F53 Chassis with 16,000 lb GVW to 22,000 lb GVW	ASH-1229 ASH-1228 9U94-18045-AA ASH-1205 AT-620 ASH-1022 1C34-18045-AA ASH-294 9U9Z-18124-A ASH-25822 ASH-25823 1C34-18045-JA AT-766	O/O	83209

VARIOUS

95-99	MotorHomes with Freightliner XC Chassis (22,000 to 26,000 lb GVW)	O/O	83160	O/O	85029
-------	---	-------	-----	-------	------	------	------	-----	-------	------	------	------

APPLICATION GUIDE

Year	Fitment Notes	OEM#								
			Fleetline\ Gas SLX	Classic\ Ultra\ ProGuard\ Guardian	Max Control\ LTV Severe Duty\ Load Carrier\ Hijackers\ OffGrid Nomads	Steering Dampers\ Steering Stabilizer\ Cab Shock	Fleetline\ Gas SLX	Classic\ Ultra\ ProGuard\ Guardian	Max Control\ LTV Severe Duty\ Load Carrier\ Hijackers\ OffGrid Nomads	Steering Dampers\ Steering Stabilizer\ Cab Shock

NATIONAL RV

NATIONAL RV

CLASS A MOTORHOMES

04-08	Models with Workhorse W20, W22, & W24 MotorHome Chassis with O.E.M. Number	W0005663 F4-BE5-F325-HO 24-153256	OIO	85124
01-08	Models with Workhorse W20, W22, & W24 MotorHome Chassis with O.E.M. Number	24-153249 F4-BE5-B492-HO W0005662 W0006254 24153249 24-186629 F4-BE5-A832-MO F4-BE5-F324-HO	OIO	85125
99-08	Models with Ford F53 Chassis with 16,000 lb GVW to 22,000 lb GVW	ASH-1229 ASH-1228 9U94-18045-AA ASH-1205 AT-620 ASH-1022 1C34-18045-AA ASH-294 9U9Z-18124-A ASH-25822 ASH-25823 1C34-18045-JA AT-766	OIO	83209
		ASH-1206 9U94-18080-AA AT-621 ASH-25824 9U9Z-18125-A ASH-1023 ASH-1230 ASH-137	OIO	83122 89406
98-00	Models with Workhorse W20, W22, & W24 MotorHome Chassis with O.E.M. Number	24-153249 F4-BE5-B492-HO W0005662 W0006254 24-186629 F4-BE5-A832-MO F4-BE5-F324-HO	OIO	85125

NEWMAR

NEWMAR



BAY STAR

24	3626, F53 Chassis with 16,000 lb GVW to 22,000 lb GVW	6U9Z18124D	OIO	83209
----	---	------------	-----	-------	------	------	------	------	------	------	------

CLASS A MOTORHOMES

	Ventana Series MotorHomes with Neway AS140 w/ 14,000 lb Front Suspension	90045455	OIO	85909
13-20	Bay Star, Bay Star Sport & Canyon Star Series MotorHomes with Ford F53 Chassis with 16,000 lb GVW to 22,000 lb GVW	ASH-1229 ASH-25822 ASH-25823 ASH-25824	OIO	83209
			OIO	83122 89406
06	Ventana Series MotorHomes with Freightliner XC Chassis AS120 Front Suspension	16-16874-000 16-16737-000 141700131810	OIO	83160
	Ventana Series MotorHomes with Freightliner XC Chassis Rear Shock with O.E.M. Number	141700131809 16-16736-000	OIO	85029
	Ventana Series MotorHomes with Freightliner XC Chassis ZF - IFS Front Suspension with 23,000 lb GVW or Greater	16-18103-000 481700000493	---	85900
02-05	Kountry Star Series MotorHomes with Freightliner XC Chassis AS120 Front Suspension	16-16874-000 16-16737-000 141700131810	OIO	83160
	Kountry Star Series MotorHomes with Freightliner XC Chassis Rear Shock with O.E.M. Number	141700131809 16-16736-000	OIO	85029
	Kountry Star Series MotorHomes with Freightliner XC Chassis ZF - IFS Front Suspension with 23,000 lb GVW or Greater	16-18103-000 481700000493	---	85900

APPLICATION GUIDE

Year	Fitment Notes	OEM#								
			Fleetline\ Gas SLX	Classic\ Ultra\ ProGuard\ Guardian	Max Control\ LTV Severe Duty\ Load Carrier\ HIJackers\ OffGrid Nomads	Steering Dampers\ Steering Stabilizer\ Cab Shock	Fleetline\ Gas SLX	Classic\ Ultra\ ProGuard\ Guardian	Max Control\ LTV Severe Duty\ Load Carrier\ HIJackers\ OffGrid Nomads	Steering Dampers\ Steering Stabilizer\ Cab Shock

NEWMAR

NEWMAR

CLASS A MOTORHOMES (cont)

02-04	Dutch Star & Moundain Aire Series MotorHomes with Freightliner XC Chassis AS120 Front Suspension	16-16874-000 16-16737-000 141700131810	O	83160
	Dutch Star & Moundain Aire Series MotorHomes with Freightliner XC Chassis Rear Shock with O.E.M. Number	141700131809 16-16736-000	O	85029
	Dutch Star & Moundain Aire Series MotorHomes with Freightliner XC Chassis ZF - IFS Front Suspension with 23,000 lb GVW or Greater	16-18103-000 481700000493	I	85900

NEXUS

NEXUS

16-20	Maybach Series MotorHomes with Ford F53 Chassis with 16,000 lb GVW to 22,000 lb GVW	ASH-1229 ASH-25822 ASH-25823	O	89414
		ASH-25824	O	89406

CLASS C MOTORHOMES

12-20	Viper Series MotorHomes with Ford E350 & E450 Chassis	ASH-1136	I	G63623	58623 77623
11-20	Phantom Series MotorHomes with Ford E350 & E450 Chassis	ASH-1136	I	G63623	58623 77623
11-12	Scenic Traveler Series MotorHomes with Ford E450 Chassis	ASH-1154	I	G63622	58622 77614
		ASH-1136	I	G63623	58623 77623

MAYBACH

17-20	MotorHomes with Ford F53 Chassis with 16,000 lb GVW to 22,000 lb GVW	ASH-1229 ASH-1228 9U94-18045-AA 1C34-18045-AA 9U9Z-18124-A ASH-25822 ASH-1022 ASH-25823 1C34-18045-JA	O	83209
		9U94-18080-AA ASH-25824 9U9Z-18125-A ASH-1023 ASH-1230	O	83122 89406



PHANTOM

11-24	MotorHomes with Ford E350 or E450 Chassis	8C2Z-18124-D 8C24-18045-DA ASH-1154 AT-163G	I	G63622	58622 77614
		8C2Z-18125-C 8C24-18080-DB 8C2Z-18125-B ASH-1136 8C2Z-18125-D 8C2Z-18125-A AT-164G	I	G63623	58623 77623

TRIUMPH

20-24	MotorHomes with Ford E350 or E450 Chassis	8C2Z-18124-D 8C24-18045-DA ASH-1154 AT-163G	I	G63622	58622 77614
		8C2Z-18125-C 8C24-18080-DB 8C2Z-18125-B ASH-1136 8C2Z-18125-D 8C2Z-18125-A AT-164G	I	G63623	58623 77623

APPLICATION GUIDE

Year	Fitment Notes	OEM#								
			Fleetline\ Gas SLX	Classic\ Ultra\ ProGuard\ Guardian	Max Control\ LTV Severe Duty\ Load Carrier\ Hijackers\ OffGrid Nomads	Steering Dampers\ Steering Stabilizer\ Cab Shock	Fleetline\ Gas SLX	Classic\ Ultra\ ProGuard\ Guardian	Max Control\ LTV Severe Duty\ Load Carrier\ Hijackers\ OffGrid Nomads	Steering Dampers\ Steering Stabilizer\ Cab Shock

NEXUS

NEXUS

VIPER

24	MotorHomes with Ford E350 or E450 Chassis	8C2Z-18124-D 8C24-18045-DA ASH-1154 AT-163G		G63622	
		8C2Z-18125-C 8C24-18080-DB 8C2Z-18125-B ASH-1136 8C2Z-18125-D 8C2Z-18125-A AT-164G		G63623
	29V	8C2Z18125D		61646	
	29V, MotorHomes with Ford E350 or E450 Chassis	8C2Z18124D		G63622
		8C2Z-18124-D 8C24-18045-DA ASH-1154 AT-163G		58622 77614
8C2Z18125D			G63623	
11-23	MotorHomes with Ford E350 or E450 Chassis	8C2Z-18124-D 8C24-18045-DA ASH-1154 AT-163G		G63622	58622 77614	
		8C2Z-18125-C 8C24-18080-DB 8C2Z-18125-B ASH-1136 8C2Z-18125-D 8C2Z-18125-A AT-164G		58623 77623	
		8C2Z18125D		G63623	

PETERBILT

PETERBILT



210

08-15	Models with Reyco 102 or 79KB Suspension (Drive Axle)	19495-01 16725-01 TK19679		83126 89430
-------	---	---------------------------------	--	------	------	------	------	------	----------------	------	------	------

220

13-24	Models with 12,000 lb Front Axle	1707378PAC BFRG 072		85182
	Models with Hendrickson HAS - 210L or HAS - 230L Rear Air Suspension	60670-008PLUS-2 60670-008 60670-008L		83123 89405
	Models with Reyco 102 or 79KB Suspension (Drive Axle)	19495-01 16725-01 TK19679		83126 89430
13-22	Models with Reyco 102AR (Standard) Rear Air Suspension	12887-02 12887-01		85013 89414
13	Models with 12,000 lb Front Axle	B71-6016A B71-6016 02-02738		85012
10	Models with 12,000 lb Front Axle	B71-6016A B71-6016 02-02738		85012
	Models with Hendrickson HAS - 210L or HAS - 230L Rear Air Suspension	60670-008PLUS-2 60670-008 60670-008L		83123 89405
	Models with Reyco 102 or 79KB Suspension (Drive Axle)	19495-01 16725-01 TK19679		83126 89430
	Models with Reyco 102AR (Standard) Rear Air Suspension	12887-02 12887-01		85013 89414

APPLICATION GUIDE

Year	Fitment Notes	OEM#								
			Fleetline/ Gas SLX	Classic/ Ultra/ ProGuard/ Guardian	Max Control/ LTV Severe Duty/ Load Carrier/ HiJackers/ OffGrid Nomads	Steering Dampers/ Steering Stabilizer/ Cab Shock	Fleetline/ Gas SLX	Classic/ Ultra/ ProGuard/ Guardian	Max Control/ LTV Severe Duty/ Load Carrier/ HiJackers/ OffGrid Nomads	Steering Dampers/ Steering Stabilizer/ Cab Shock

PETERBILT

PETERBILT

220 (cont)

07	Models with 12,000 lb Front Axle	B71-6016A B71-6016 02-02738	OO	85012	
	Models with Hendrickson HAS - 210L or HAS - 230L Rear Air Suspension	60670-008PLUS-2 60670-008 60670-008L	OO	OO	83123 89405
	Models with Reyco 102 or 79KB Suspension (Drive Axle)	19495-01 16725-01 TK19679	OO	OO	83126 89430
	Models with Reyco 102AR (Standard) Rear Air Suspension	12887-02 12887-01	OO	OO	85013 89414

325

08-19	Models with 12000 lb Set Back Front Axle	B71-6016A B71-6016 02-02738	OO	85012
	Models with Reyco 102 or 79KB Suspension (Drive Axle)	19495-01 TK19679	OO	OO	83126 89430
08-15	Models with 8,000 lb Front Axle	B71-6004	OO	85084

330

08-15	Models with O.E.M. Number	B71-6017 02-03020	OO	85910
-------	---------------------------	----------------------	----	-------	------	------	------	------	------	------	------

335

05-10	Models with 12000 lb Set Back Front Axle	02-02741 B71-6016A B71-6016 02-02738	OO	85012	
	Models with Air Trac Suspension (46,000 lb)	03-07421	OO	I	85311 89424
	Models with Peterbilt Low Air Leaf Suspension	03-08781 C71-1017 C71-1011	OO	I	85069 89455

536

22-24	Models with 10,000 lb to 14,600 lb Taperleaf Springs and Set Back Front Axles	B71-6019	OO	85989	
	Models with Air Trac Suspension (40,000 lb)	C71-6003	OO	I	85988
	Models with Peterbilt Low Air Leaf Suspension	C71-1017	OO	I	85069 89455

PHOENIX

PHOENIX

CRUISER

00-23	MotorHomes with Ford E350 or E450 Chassis	8C2Z-18124-D 8C24-18045-DA ASH-1154 AT-163G	I	G63622	58622 77614
		8C24-18080-DB ASH-1136 8C2Z-18125-D AT-164G	I	I	G63623	58623 77623

TRX

20-22	MotorHomes with Ford Transit-350 Chassis		I	G57816 ⁰⁰	OO	G64177
-------	--	--	---	------	----------------------	------	------	----	------	--------	------	------



PIERCE MFG. INC.

PIERCE MFG. INC.

VARIOUS

09-24	Models with Freightliner Chassis (M2 106 or 108SD with 8000 to 16000 lb Front Axle and Taperleaf Spring)	10-13760-000 10-13592-000 471700000440 471700002991 SDA471700002991	OO	85959
-------	--	---	----	-------	------	------	------	------	------	------	------

APPLICATION GUIDE

Year	Fitment Notes	OEM#								
			Fleetline\ Gas SLX	Classic\ Ultra\ ProGuard\ Guardian	Max Control\ LTV Severe Duty\ Load Carrier\ HiJackers\ OffGrid Nomads	Steering Dampers\ Steering Stabilizer\ Cab Shock	Fleetline\ Gas SLX	Classic\ Ultra\ ProGuard\ Guardian	Max Control\ LTV Severe Duty\ Load Carrier\ HiJackers\ OffGrid Nomads	Steering Dampers\ Steering Stabilizer\ Cab Shock

PIERCE MFG. INC.

VARIOUS (cont)

PIERCE MFG. INC.

09-24	Models with Freightliner Chassis (M2 112 or 114SD with 12000 lb to 20000 lb Front Axle)	10-13809-000 471700003920	010	85958
03-24	Models with Freightliner M2 112 Chassis (Day Cab Models with Spring Suspensions)	18-47349-000 814903003483 18-60767-000	010	83039
02-24	Models with Freightliner Chassis (M2 106, 108SD or 114SD with Day Cab Models and Spring Suspensions)	18-47350-000 18-60766-000 814903003482	010	83040
19-23	Models with International HV Chassis with 11,000 lb to 14,000 lb Taper-leaf Springs	6127714C1	010	85928
	Models with International HV Chassis with Hendrickson HMX 400/460 Haulmax with 16.5" Saddle	60680-004L 60680-004	010	83143
	Models with International HV Chassis with Hendrickson HMX 400/460 Haulmax with 17.5" & 18.5" Saddle	60680-005L HDR60680-005 60680-005	010	83142
	Models with International HV Chassis with Hendrickson Primaax 230/460 Air Suspension with 9" Ride Height	60657-003 3626571C2 60657-003L	010	85072
	Models with International HV Chassis with Link Cab Mate Suspension	1201-9008 2509223C92 2509223C91	010	83054
17-23	Models with Ford F-450 or F-550 Chassis (4WD and OEM number)	ASH-85927 LC3Z-18125-W ASH-866127 ASH-866139 LC3Z-18125-J HC3Z-18125-EP HC3Z-18125-X ASH-85789	010	77986
20-22	Models with International MV Chassis with 20,000 lb IROS Air Suspension	6127713C2	010	85656
19-22	Models with International MV Chassis with 9,000 to 10,000 lb Front Suspension	6127088C1	010	83163
	Models with International MV Chassis with Hendrickson HAS - 230 Rear Air Suspension	60675-003 H60675-003 3514952C1 60675-003L	010	85976
03-22	Models with Freightliner M2 112 Chassis (Crew Cab Models with O.E.M. Number)	18-41762-000 814903003528 18-60764-000	010	83038
19-21	Models with International HV Chassis with 16,000 lb to 23,000 lb Parabolic Taperleaf Springs	3576464C2	010	85957
	Models with International HV Chassis with 18,000 to 20,000 lb (Set Forward) Front Axle	3868265C1	010	85995



RAM

4500

RAM

12-18	Models with O.E.M. Number	05168295AB 05168284AC 6811 1104AB-001 6811 1105AC 6811 1105AC-001 6811 1104AB	010	85649
		05168296AA 6811 1107AA 6811 1107AA-001	010	85650

APPLICATION GUIDE

Year	Fitment Notes	OEM#								
			Fleetline\ Gas SLX	Classic\ Ultra\ ProGuard\ Guardian	Max Control\ LTV Severe Duty\ Load Carrier\ HiJackers\ OffGrid Nomads	Steering Dampers\ Steering Stabilizer\ Cab Shock	Fleetline\ Gas SLX	Classic\ Ultra\ ProGuard\ Guardian	Max Control\ LTV Severe Duty\ Load Carrier\ HiJackers\ OffGrid Nomads	Steering Dampers\ Steering Stabilizer\ Cab Shock

RAM

RAM

5500

12-18	Models with O.E.M. Number	05168295AB 05168284AC 6811 1104AB-001 6811 1105AC 6811 1105AC-001 6811 1104AB	↓ ○	85649
		05168296AA 6811 1107AA 6811 1107AA-001	↓ ○	85650

PROMASTER 3500

26	Ram Promaster with OEM #6815 7795AE Strut Left	6815 7795AE	↓ ○	G57800
	Ram Promaster with OEM #6815 7795AE Strut Right	6815 7795AE	↓ ○	G57801

RENEGADE

RENEGADE

VALENCIA

18-24	Models with Freightliner S2RV chassis	10-13976-000	↓ ○	85918
		16-16764-000	↓ ○	85724 89443

VERACRUZ

19-23	Models with Ford F-550 Chassis (4WD and OEM number)	ASH-85927 LC3Z-18125-W ASH-866127 ASH-866139 LC3Z-18125-J HC3Z-18125-EP HC3Z-18125-X ASH-85789	↓ ○	77986
-------	---	---	--------	------	------	------	------	------	-------	------	------

SHASTA RV

SHASTA RV

ALL MODELS

	MotorHomes with Ford E350 Chassis	8C2Z-18124-D 8C24-18045-DA ASH-1154 AT-163G	↓ ○	G63622	58622 77614
		8C24-18080-DB ASH-1136 8C2Z-18125-D AT-164G	↓ ○	G63623	58623 77623
	MotorHomes with Ford E450 Chassis	8C2Z-18124-D 8C24-18045-DA ASH-1154 AT-163G	↓ ○	G63622	58622 77614
		8C24-18080-DB ASH-1136 8C2Z-18125-D AT-164G	↓ ○	G63623	58623 77623



STARCRAFT BUS CO.

STARCRAFT BUS CO.

E350 & E450 FORD CHASSIS MODELS

	Allstar Series Shuttle buses with Ford E350 & E450 Chassis To 2020	ASH-1136	↓ ○	G63623	58623 77623
	Allstar Series Shuttle buses with Ford E350 & E450 Chassis To 2022	ASH-1154	↓ ○	G63622	58622 77614	
	MVP Series Shuttle buses with Ford E450 Chassis To 2020	ASH-1136	↓ ○	G63623	58623 77623
	MVP Series Shuttle buses with Ford E450 Chassis To 2022	ASH-1154	↓ ○	G63622	58622 77614	
	Starlite Series Shuttle buses with Ford E350 & E450 Chassis To 2020	ASH-1136	↓ ○	G63623	58623 77623

APPLICATION GUIDE

Year	Fitment Notes	OEM#								
			Fleetline\ Gas SLX	Classic\ Ultra\ ProGuard\ Guardian	Max Control\ LTV Severe Duty\ Load Carrier\ Hijackers\ OffGrid Nomads	Steering Dampers\ Steering Stabilizer\ Cab Shock	Fleetline\ Gas SLX	Classic\ Ultra\ ProGuard\ Guardian	Max Control\ LTV Severe Duty\ Load Carrier\ Hijackers\ OffGrid Nomads	Steering Dampers\ Steering Stabilizer\ Cab Shock

STARCRAFT BUS CO.

STARCRAFT BUS CO.

E350 & E450 FORD CHASSIS MODELS (cont)

	Starlite Series Shuttle buses with Ford E350 & E450 Chassis To 2022	ASH-1154	O	G63622	58622 77614
	Starquest Series Shuttle buses with Ford E350 & E450 Chassis To 2020	ASH-1136	O	G63623	58623 77623
	Starquest Series Shuttle buses with Ford E350 & E450 Chassis To 2022	ASH-1154	O	G63622	58622 77614
	Ultra Star Series Shuttle buses with Ford E450 Chassis To 2020	ASH-1154	O	G63622	58622 77614
		ASH-1136	O	G63623	58623 77623
	Xpress Series Shuttle buses with Ford E350 & E450 Chassis To 2020	ASH-1154	O	G63622	77614
		ASH-1136	O	G63623	58623 77623

STERLING TRUCK

STERLING TRUCK

ACTERRA

	Models with 11000 to 12000 lb Front axle	6803230300	O	85006
03-10	All Models with Freightliner TufTrac Rear Air Suspension	481700125969 16-15770-000	O	85956
	Models with 15000 lb Rear Suspension	6803260000	O	83120
	Models with FAS II (40,000 lb) Rear Air Suspension	16-15817-000 16-13957-000 XC45-18080-BA	O	85724 89443
	Models with Hendrickson Front Airtek	58913-003L 471700131331 58913-003	O	85932
01-09	Models with 10000 to 12000 lb. Taper-leaf Spring Suspension	10-12390-000	O	85920
	Models with 6000 to 9000 lb Front axle	10-12388-000	O	85920

ACTERRA 5500

01-07	Models with 15000 lb Rear Suspension	6803260000	O	83120
	Models with FAS II (40,000 lb) Rear Air Suspension	16-15817-000 16-13957-000 XC45-18080-BA	O	85724 89443
	Models with Hendrickson Front Airtek	58913-003L 471700131331 58913-003	O	85932



ACTERRA 6500

01-07	Models with 15000 lb Rear Suspension	6803260000	O	83120
	Models with FAS II (40,000 lb) Rear Air Suspension	16-15817-000 16-13957-000 XC45-18080-BA	O	85724 89443
	Models with Hendrickson Front Airtek	58913-003L 471700131331 58913-003	O	85932

BULLET 45

08-10	Models with O.E.M. Number	05168295AB 05168284AC 6811 1104AB-001 6811 1105AC 6811 1105AC-001 6811 1104AB	O	85649
		05168296AA 6811 1107AA 6811 1107AA-001	O	85650

APPLICATION GUIDE

Year	Fitment Notes	OEM#								
			Fleetline\ Gas SLX	Classic\ Ultra\ ProGuard\ Guardian	Max Control\ LTV Severe Duty\ Load Carrier\ HiJackers\ OffGrid Nomads	Steering Dampers\ Steering Stabilizer\ Cab Shock	Fleetline\ Gas SLX	Classic\ Ultra\ ProGuard\ Guardian	Max Control\ LTV Severe Duty\ Load Carrier\ HiJackers\ OffGrid Nomads	Steering Dampers\ Steering Stabilizer\ Cab Shock

STERLING TRUCK

BULLET 55

08-10	Models with O.E.M. Number	05168295AB 05168284AC 6811 1104AB-001 6811 1105AC 6811 1105AC-001 6811 1104AB	 O	85649
		05168296AA 6811 1107AA 6811 1107AA-001	 O

STERLING TRUCK

THOMAS

TYPE A SCHOOL BUS



00-22	Minotour Type A School bus with Ford E450 Chassis	8C2Z-18124-D 8C24-18045-DA ASH-1154 AT-163G	 O	G63622	58622 77614
92-22	Minotour Type A School bus with Ford E350 Chassis	8C2Z-18124-D 8C24-18045-DA ASH-1154 AT-163G	 O	G63622	58622 77614
00-20	Minotour Type A School bus with Ford E450 Chassis	8C24-18080-DB ASH-1136 8C2Z-18125-D AT-164G	 O	G63623	58623 77623
92-20	Minotour Type A School bus with Ford E350 Chassis	8C24-18080-DB ASH-1136 8C2Z-18125-D AT-164G	 O	G63623	58623 77623

THOMAS

VARIOUS

	Buses with Neway Tandem Air Suspension	61310232	 O	85000 89436
	Buses with O.E.M. Number	16-19138-000	 O	85058
	Model MVP	61310101	 O	85736
	Models with Hendrickson Comfort Air Rear Air Suspension	60670-006 60670-006L	 O	83147
	ROC Front, SAF-T-Liner	61300285 GBL651442	 I	83102
	SAF-T-Liner HDX Models with Hendrickson Comfort Air Rear Air Suspension	471700131545 60998-001 60998-003	 O	85006
	SAF-T-Liner School Bus MVP-ER & MVP-EF	61300219 70445 61300222 61300223	 O	85014
	School Bus	614974	 O	85304
		00614966 300-0614966	 O	85307
	Type C Conventional Buses (65 capacity) with FAS II Rear Air Suspension To 2017	16-15817-000 16-18708-000 61310434 61310478	 O	85724 89443
05-22	Models with Freightliner B2 Bus Chassis & 15000 lb Rear Suspension	6803260000	 O	83120
03	Type C Conventional School buses (65 capacity) with O.E.M. Number	6803230300 GBL665538	 O	85006

APPLICATION GUIDE

Year	Fitment Notes	OEM#								
			Fleetline\ Gas SLX	Classic\ Ultra\ ProGuard\ Guardian	Max Control\ LTV Severe Duty\ Load Carrier\ Hijackers\ OffGrid Nomads	Steering Dampers\ Steering Stabilizer\ Cab Shock	Fleetline\ Gas SLX	Classic\ Ultra\ ProGuard\ Guardian	Max Control\ LTV Severe Duty\ Load Carrier\ Hijackers\ OffGrid Nomads	Steering Dampers\ Steering Stabilizer\ Cab Shock

THOR MOTOR COACH

THOR MOTOR COACH

A.C.E.

11-24	MotorHomes with Ford F53 Chassis with 16,000 lb GVW to 22,000 lb GVW	ASH-1229 ASH-1228 9U94-18045-AA ASH-1205 AT-620 ASH-1022 1C34-18045-AA ASH-294 9U9Z-18124-A ASH-25822 ASH-25823 1C34-18045-JA AT-766	83209								
		ASH-1206 9U94-18080-AA AT-621 ASH-25824 9U9Z-18125-A ASH-1023 ASH-1230 ASH-137	010	83122 89406	010						

AXIS

25-26	26.2, Motorhomes with Ford E450 Chassis	8C2Z-18124-D	010			77614					
26	Motorhomes with Ford E450 Chassis	8C2Z-18125-D	010					61646	77623		
	With Ford E-450 Super Duty	8C2Z-18125-D	010					G63623	58623		
	26.2, With Ford E-450 Super Duty	8C2Z-18124-D	010		G63622	58622					
25	Motorhomes with Ford E450 Chassis	8C2Z-18125-D	010						77623		
14-24	MotorHomes with Ford E350 or E450 Chassis	8C2Z-18124-D 8C24-18045-DA ASH-1154 AT-163G	010		G63622	58622 77614					
		8C24-18080-DB ASH-1136 8C2Z-18125-D AT-164G	010				G63623	58623 77623			

CHALLENGER

09-24	MotorHomes with Ford F53 Chassis with 16,000 lb GVW to 22,000 lb GVW	ASH-1229 ASH-1228 9U94-18045-AA ASH-1205 AT-620 ASH-1022 1C34-18045-AA ASH-294 9U9Z-18124-A ASH-25822 ASH-25823 1C34-18045-JA AT-766	83209								
		ASH-1206 9U94-18080-AA AT-621 ASH-25824 9U9Z-18125-A ASH-1023 ASH-1230 ASH-137	010	83122 89406	010						
05-08	MotorHomes with Ford F53 Chassis with 16,000 lb GVW to 22,000 lb GVW	ASH-1229 ASH-1228 9U94-18045-AA ASH-1205 AT-620 ASH-1022 1C34-18045-AA ASH-294 9U9Z-18124-A ASH-25822 ASH-25823 1C34-18045-JA AT-766	83209								

APPLICATION GUIDE

Year	Fitment Notes	OEM#								
			Fleetline\ Gas SLX	Classic\ Ultra\ ProGuard\ Guardian	Max Control\ LTV Severe Duty\ Load Carrier\ HiJackers\ OffGrid Nomads	Steering Dampers\ Steering Stabilizer\ Cab Shock	Fleetline\ Gas SLX	Classic\ Ultra\ ProGuard\ Guardian	Max Control\ LTV Severe Duty\ Load Carrier\ HiJackers\ OffGrid Nomads	Steering Dampers\ Steering Stabilizer\ Cab Shock

THOR MOTOR COACH CHALLENGER (cont)

THOR MOTOR COACH

05-08	MotorHomes with Ford F53 Chassis with 16,000 lb GVW to 22,000 lb GVW	ASH-1206 9U94-18080-AA AT-621 ASH-25824 9U9Z-18125-A ASH-1023 ASH-1230 ASH-137			83122 89406
-------	--	---	--	------	------	------	------	--	----------------	------	------	------

CHATEAU

11-24	MotorHomes with Ford E350 or E450 Chassis	8C2Z-18124-D 8C24-18045-DA ASH-1154 AT-163G		G63622	58622 77614
		8C24-18080-DB ASH-1136 8C2Z-18125-D AT-164G			G63623	58623 77623
99-10	MotorHomes with Ford E350 or E450 Chassis	8C24-18080-DB ASH-1136 8C2Z-18125-D AT-164G			G63623

CHATEAU CITATION

13	MotorHomes with Ford E350 or E450 Chassis	8C24-18080-DB ASH-1136 8C2Z-18125-D AT-164G			G63623
11-12	MotorHomes with Ford E350 or E450 Chassis	8C2Z-18124-D 8C24-18045-DA ASH-1154 AT-163G		G63622	58622 77614
		8C24-18080-DB ASH-1136 8C2Z-18125-D AT-164G			G63623	58623 77623
08-10	MotorHomes with Ford E350 or E450 Chassis	8C24-18080-DB ASH-1136 8C2Z-18125-D AT-164G			G63623



CITATION

12-16	MotorHomes with Ford E350 or E450 Chassis	8C2Z-18124-D 8C24-18045-DA ASH-1154 AT-163G		G63622	58622 77614
		8C24-18080-DB ASH-1136 8C2Z-18125-D AT-164G			G63623	58623 77623
01-11	MotorHomes with Ford E350 or E450 Chassis	8C24-18080-DB ASH-1136 8C2Z-18125-D AT-164G			G63623

CLASS A MOTORHOMES

06	Astoria Series MotorHomes with Freightliner XC Chassis ADL200 Suspension w/ 20K Rear	16-16873-000			85029
	Astoria Series MotorHomes with Freightliner XC Chassis AS120 Front Suspension	16-16874-000 16-16737-000 141700131810		83160
	Astoria Series MotorHomes with Freightliner XC Chassis Rear Shock with O.E.M. Number	141700131809 16-16736-000			85029
	Astoria Series MotorHomes with Freightliner XC Chassis ZF - IFS Front Suspension with 23,000 lb GVW or Greater	16-18103-000 481700000493		85900
	Tuscany Series MotorHomes with Freightliner XC Chassis ADL200 Suspension w/ 20K Rear	16-16873-000			85029
	Tuscany Series MotorHomes with Freightliner XC Chassis AS120 Front Suspension	16-16874-000 16-16737-000 141700131810		83160

APPLICATION GUIDE

Year	Fitment Notes	OEM#								
			Fleetline\ Gas SLX	Classic\ Ultra\ ProGuard\ Guardian	Max Control\ LTV Severe Duty\ Load Carrier\ Hijackers\ OffGrid Nomads	Steering Dampers\ Steering Stabilizer\ Cab Shock	Fleetline\ Gas SLX	Classic\ Ultra\ ProGuard\ Guardian	Max Control\ LTV Severe Duty\ Load Carrier\ Hijackers\ OffGrid Nomads	Steering Dampers\ Steering Stabilizer\ Cab Shock

THOR MOTOR COACH

THOR MOTOR COACH

CLASS A MOTORHOMES (cont)

06	Tuscany Series MotorHomes with Freightliner XC Chassis Rear Shock with O.E.M. Number	141700131809 16-16736-000		85029
	Tuscany Series MotorHomes with Freightliner XC Chassis ZF - IFS Front Suspension with 23,000 lb GVW or Greater	16-18103-000 481700000493		85900
02-05	Escaper Series MotorHomes with Freightliner XC Chassis ADL200 Suspension w/ 20K Rear	16-16873-000		85029
	Escaper Series MotorHomes with Freightliner XC Chassis AS120 Front Suspension	16-16874-000 16-16737-000 141700131810		83160
	Escaper Series MotorHomes with Freightliner XC Chassis Rear Shock with O.E.M. Number	141700131809 16-16736-000		85029
	Escaper Series MotorHomes with Freightliner XC Chassis ZF - IFS Front Suspension with 23,000 lb GVW or Greater	16-18103-000 481700000493		85900
	UltraSport Series MotorHomes with Freightliner XC Chassis ADL200 Suspension w/ 20K Rear	16-16873-000		85029
	UltraSport Series MotorHomes with Freightliner XC Chassis AS120 Front Suspension	16-16874-000 16-16737-000 141700131810		83160
	UltraSport Series MotorHomes with Freightliner XC Chassis Rear Shock with O.E.M. Number	141700131809 16-16736-000		85029
	UltraSport Series MotorHomes with Freightliner XC Chassis ZF - IFS Front Suspension with 23,000 lb GVW or Greater	16-18103-000 481700000493		85900

DAZZLE

25	2JB, Left		G57801 ⁴⁰
	2JB, Right		G57801 ⁴⁰

ECHELON

22-24	MotorHomes with Ford E350 or E450 Chassis	8C2Z-18124-D 8C24-18045-DA ASH-1154		G63622	58622 77614
		8C24-18080-DB ASH-1136 8C2Z-18125-D		G63623	58623 77623



FOUR WINDS

11-24	MotorHomes with Ford E350 or E450 Chassis	8C2Z-18124-D 8C24-18045-DA ASH-1154 AT-163G		G63622	58622 77614
		8C24-18080-DB ASH-1136 8C2Z-18125-D AT-164G		G63623	58623 77623
24	28A, MotorHomes with Ford E350 or E450 Chassis	8C2Z-18124-D 8C24-18045-DA ASH-1154 AT-163G		77614
01-10	MotorHomes with Ford E350 or E450 Chassis	8C24-18080-DB ASH-1136 8C2Z-18125-D AT-164G		G63623

FOUR WINDS 282

25	All	8C2Z18124D		G63622
				61646	58623

APPLICATION GUIDE

Year	Fitment Notes	OEM#								
			Fleetline\ Gas SLX	Classic\ Ultra\ ProGuard\ Guardian	Max Control\ LTV Severe Duty\ Load Carrier\ HiJackers\ OffGrid Nomads	Steering Dampers\ Steering Stabilizer\ Cab Shock	Fleetline\ Gas SLX	Classic\ Ultra\ ProGuard\ Guardian	Max Control\ LTV Severe Duty\ Load Carrier\ HiJackers\ OffGrid Nomads	Steering Dampers\ Steering Stabilizer\ Cab Shock

THOR MOTOR COACH

THOR MOTOR COACH

FOUR WINDS 282 (cont)

25	All	8C2Z18125D	I					O		G63623	77623	
	MotorHomes with Ford E350 or E450 Chassis		I			58622		O				
		8C2Z18124D	I			77614		O				

FREEDOM ELITE

12-24	MotorHomes with Ford E350 or E450 Chassis	8C2Z-18124-D 8C24-18045-DA ASH-1154 AT-163G	I		G63622	58622 77614		O				
		8C24-18080-DB ASH-1136 8C2Z-18125-D AT-164G	I					O		G63623	58623 77623	
10-11	MotorHomes with Ford E350 or E450 Chassis	8C24-18080-DB ASH-1136 8C2Z-18125-D AT-164G	I					O		G63623		

GEMINI

19-22	MotorHomes with Ford Transit-350 Chassis		I		G57816 ⁴⁰			O		G64177		
-------	--	--	---	--	----------------------	--	--	---	--	--------	--	--



HURRICANE

11-24	MotorHomes with Ford F53 Chassis with 16,000 lb GVW to 22,000 lb GVW	ASH-1229 ASH-1228 9U94-18045-AA ASH-1205 AT-620 ASH-1022 1C34-18045-AA ASH-294 9U9Z-18124-A ASH-25822 ASH-25823 1C34-18045-JA AT-766	OO	83209				OO					
		ASH-1206 9U94-18080-AA AT-621 ASH-25824 9U9Z-18125-A ASH-1023 ASH-1230 ASH-137	OO						OO	83122 89406			
		ASH-1229 ASH-1228 9U94-18045-AA ASH-1205 AT-620 ASH-1022 1C34-18045-AA ASH-294 9U9Z-18124-A ASH-25822 ASH-25823 1C34-18045-JA AT-766	OO	83209					OO				
04-10	MotorHomes with Ford F53 Chassis with 16,000 lb GVW to 22,000 lb GVW	ASH-1206 9U94-18080-AA AT-621 ASH-25824 9U9Z-18125-A ASH-1023 ASH-1230 ASH-137	OO					OO	83122 89406				

INCEPTION

22-24	Models with Freightliner S2RV chassis	10-13976-000	OO	85918				OO				
		16-16764-000	OO					OO	85724 89443			

APPLICATION GUIDE

Year	Fitment Notes	OEM#								
			Fleetline\ Gas SLX	Classic\ Ultra\ ProGuard\ Guardian	Max Control\ LTV Severe Duty\ Load Carrier\ HiJackers\ OffGrid Nomads	Steering Dampers\ Steering Stabilizer\ Cab Shock	Fleetline\ Gas SLX	Classic\ Ultra\ ProGuard\ Guardian	Max Control\ LTV Severe Duty\ Load Carrier\ HiJackers\ OffGrid Nomads	Steering Dampers\ Steering Stabilizer\ Cab Shock

THOR MOTOR COACH INDIGO

THOR MOTOR COACH

23-24	MotorHomes with Ford F53 Chassis with 16,000 lb GVW to 22,000 lb GVW	9U94-18045-AA 9U9Z-18124-A ASH-25822 ASH-25823	OIO	83209
		9U94-18080-AA ASH-25824 9U9Z-18125-A	OIO	83122 89406

LUMINATE

23-24	MotorHomes with Ford F53 Chassis with 16,000 lb GVW to 22,000 lb GVW	9U94-18045-AA 9U9Z-18124-A ASH-25822 ASH-25823	OIO	83209
		9U94-18080-AA ASH-25824 9U9Z-18125-A	OIO	83122 89406

MAGNITUDE

19-23	Models with Ford F-550 Chassis (4WD and OEM number)	ASH-85927 LC3Z-18125-W ASH-866127 ASH-866139 LC3Z-18125-J HC3Z-18125-EP HC3Z-18125-X ASH-85789	OIO	OIO	77986
	Models with Ford F-550 Chassis (RWD and OEM number)	ASH-25770 HC3Z-18125-ED HC3Z-18125-EE HC3Z-18125-B ASH-85857 ASH-85856	OIO	OIO	77987

MIRAMAR

14-24	MotorHomes with Ford F53 Chassis with 16,000 lb GVW to 22,000 lb GVW	ASH-1229 ASH-1228 9U94-18045-AA ASH-1205 AT-620 ASH-1022 1C34-18045-AA ASH-294 9U9Z-18124-A ASH-25822 ASH-25823 1C34-18045-JA AT-766	OIO	83209
		ASH-1206 9U94-18080-AA AT-621 ASH-25824 9U9Z-18125-A ASH-1023 ASH-1230 ASH-137	OIO	83122 89406



OMNI

19-23	Models with Ford F-550 Chassis (4WD and OEM number)	ASH-85927 LC3Z-18125-W ASH-866127 ASH-866139 LC3Z-18125-J HC3Z-18125-EP HC3Z-18125-X ASH-85789	OIO	OIO	77986
	Models with Ford F-550 Chassis (RWD and OEM number)	ASH-25770 HC3Z-18125-ED HC3Z-18125-EE HC3Z-18125-B ASH-85857 ASH-85856	OIO	OIO	77987

OUTLAW

11-24	MotorHomes with Ford F53 Chassis with 24,000 lb GVW to 26,000 lb GVW	ASH-25821 ASH-1161	OIO	85006
-------	--	-----------------------	-----	-------	------	------	------	------	------	------	------	------

APPLICATION GUIDE

Year	Fitment Notes	OEM#								
			Fleetline\ Gas SLX	Classic\ Ultra\ ProGuard\ Guardian	Max Control\ LTV Severe Duty\ Load Carrier\ HiJackers\ OffGrid Nomads	Steering Dampers\ Steering Stabilizer\ Cab Shock	Fleetline\ Gas SLX	Classic\ Ultra\ ProGuard\ Guardian	Max Control\ LTV Severe Duty\ Load Carrier\ HiJackers\ OffGrid Nomads	Steering Dampers\ Steering Stabilizer\ Cab Shock

THOR MOTOR COACH OUTLAW (cont)



THOR MOTOR COACH

24	MotorHomes with Ford F53 Chassis with 24,000 lb GVW to 26,000 lb GVW	ASH-25820 ASH-1162	I	O	O	O	89430	
11-23	MotorHomes with Ford E350 or E450 Chassis	8C2Z-18124-D 8C24-18045-DA ASH-1154 AT-163G	I	O	G63622	58622 77614	O	O	
		8C24-18080-DB ASH-1136 8C2Z-18125-D AT-164G	I	O	O	O	G63623	58623 77623
07-10	MotorHomes with Ford F53 Chassis with 16,000 lb GVW to 22,000 lb GVW	ASH-1229 ASH-1228 9U94-18045-AA ASH-1205 AT-620 ASH-1022 1C34-18045-AA ASH-294 9U9Z-18124-A ASH-25822 ASH-25823 1C34-18045-JA AT-766	O	O	83209	O	O	
		ASH-1206 9U94-18080-AA AT-621 ASH-25824 9U9Z-18125-A ASH-1023 ASH-1230 ASH-137	O	O	O	O	83122 89406
		ASH-25820 ASH-1162	O	O	O	O	85005 89430

PASADENA

26	Motorhomes with Ford E350 Chassis	8C2Z-18124-D	I	O	77614	O	O
	SE19 Model; Motorhomes with Ford E350 Chassis	8C2Z-18125-D	I	O	O	O	61646
	SE19 Submodel; With Ford E-350 Super Duty	8C2Z-18124-D	I	O	G63622	O	O
		8C2Z-18125-D	I	O	O	O	G63623
	SE19 Submodel; with Ford E-450 Super Duty	8C2Z-18125-D	I	O	O	O	58623
SE19 Submodel; with Ford E=450 Super Duty	8C2Z-18124-D	I	O	58622	O	O	
25	SE19 Model; Motorhomes with Ford E350 Chassis	8C2Z-18125-D	I	O	O	O	77623
22-24	Models with Freightliner S2RV chassis	10-13976-000	O	O	85918	O	O
		16-16764-000	O	O	O	O	85724 89443

APPLICATION GUIDE

Year	Fitment Notes	OEM#								
			Fleetline\ Gas SLX	Classic\ Ultra\ ProGuard\ Guardian	Max Control\ LTV Severe Duty\ Load Carrier\ Hijackers\ OffGrid Nomads	Steering Dampers\ Steering Stabilizer\ Cab Shock	Fleetline\ Gas SLX	Classic\ Ultra\ ProGuard\ Guardian	Max Control\ LTV Severe Duty\ Load Carrier\ Hijackers\ OffGrid Nomads	Steering Dampers\ Steering Stabilizer\ Cab Shock

THOR MOTOR COACH QUANTUM

THOR MOTOR COACH

16-24	MotorHomes with Ford E350 or E450 Chassis	8C2Z-18124-D 8C24-18045-DA ASH-1154 AT-163G	OI	G63622	58622 77614
		8C24-18080-DB ASH-1136 8C2Z-18125-D AT-164G	OI	G63623	58623 77623

RESONATE

23-24	MotorHomes with Ford F53 Chassis with 16,000 lb GVW to 22,000 lb GVW	9U94-18045-AA 9U9Z-18124-A ASH-25822 ASH-25823	OI	83209
		9U94-18080-AA ASH-25824 9U9Z-18125-A	OI	83122 89406

SCOPE

24	18M, Left	OI	G57800 ⁴⁰
	18M, Right	OI	G57801 ⁴⁰



VEGAS

25	24.1	8C2Z18124D	OI	G63622
			OI	77614
		8C2Z18125D	OI	61646 G63623	77623
	24.1, MotorHomes with Ford E350 or E450 Chassis	8C2Z-18124-D 8C24-18045-DA ASH-1154 AT-163G	OI	58622
		8C24-18080-DB ASH-1136 8C2Z-18125-D AT-164G	OI	58623
14-24	MotorHomes with Ford E350 or E450 Chassis	8C2Z-18124-D 8C24-18045-DA ASH-1154 AT-163G	OI	G63622	58622 77614
		8C24-18080-DB ASH-1136 8C2Z-18125-D AT-164G	OI	G63623	58623 77623
24	24.1	8C2Z18125D	OI	G63623

WINDSPORT

11-24	MotorHomes with Ford F53 Chassis with 16,000 lb GVW to 22,000 lb GVW	ASH-1229 ASH-1228 9U94-18045-AA ASH-1205 AT-620 ASH-1022 1C34-18045-AA ASH-294 9U9Z-18124-A ASH-25822 ASH-25823 1C34-18045-JA AT-766	OI	83209
		ASH-1206 9U94-18080-AA AT-621 ASH-25824 9U9Z-18125-A ASH-1023 ASH-1230 ASH-137	OI	83122 89406

APPLICATION GUIDE

Year	Fitment Notes	OEM#								
			Fleetline\ Gas SLX	Classic\ Ultra\ ProGuard\ Guardian	Max Control\ LTV Severe Duty\ Load Carrier\ HiJackers\ OffGrid Nomads	Steering Dampers\ Steering Stabilizer\ Cab Shock	Fleetline\ Gas SLX	Classic\ Ultra\ ProGuard\ Guardian	Max Control\ LTV Severe Duty\ Load Carrier\ HiJackers\ OffGrid Nomads	Steering Dampers\ Steering Stabilizer\ Cab Shock

THOR MOTOR COACH WINDSPORT (cont)

THOR MOTOR COACH

06-10	MotorHomes with Ford F53 Chassis with 16,000 lb GVW to 22,000 lb GVW	ASH-1229 ASH-1228 9U94-18045-AA ASH-1205 AT-620 ASH-1022 1C34-18045-AA ASH-294 9U9Z-18124-A ASH-25822 ASH-25823 1C34-18045-JA AT-766	O O	83209
		ASH-1206 9U94-18080-AA AT-621 ASH-25824 9U9Z-18125-A ASH-1023 ASH-1230 ASH-137	O O	83122 89406

TIFFIN

TIFFIN

ALLEGRO OPEN ROAD

25	34PA, F53 Chassis with 16,000 lb GVW to 22,000 lb GVW	6U9Z18124D	O O	83209
----	---	------------	--------	-------	------	------	------	------	------	------	------	------

TURTLETOP BUS

TURTLETOP BUS

VARIOUS

	Odyssey Series Shuttle buses with Ford E450 Chassis To 2020	ASH-1136		I O	G63623	58623 77623
	Odyssey Series Shuttle buses with Ford E450 Chassis To 2022	ASH-1154	I O	G63622	58622 77614	I O
	Terra Transit Series Shuttle buses with Ford E350 & E450 Chassis To 2020	ASH-1154	I O	G63622	58622 77614	I O
		ASH-1136	I O	I O	G63623	58623 77623
	Vanterra Series Shuttle buses with Ford E350 Chassis To 2020	ASH-1154	I O	G63622	58622 77614	I O
		ASH-1136	I O	I O	G63623	58623 77623

UD

UD

1200

99-04	Models with O.E.M. Number	E61000T825 561000T825	I O	83515
-------	---------------------------	--------------------------	--------	-------	------	------	------	------	------	------	------	------

1300

05-07	Models with O.E.M. Number	E61000T825 561000T825	I O	83515
-------	---------------------------	--------------------------	--------	-------	------	------	------	------	------	------	------	------

1400

94-10	Models with O.E.M. Number	E61000T825 561000T825	I O	83515
-------	---------------------------	--------------------------	--------	-------	------	------	------	------	------	------	------	------

1800

89-94	Models with O.E.M. Number	56101-Z5008 56110-Z5008	I O	83114
-------	---------------------------	----------------------------	--------	-------	------	------	------	------	------	------	------	------



1800CS

99-04	Models with O.E.M. Number	56101-Z5008 56110-Z5008	I O	83114
-------	---------------------------	----------------------------	--------	-------	------	------	------	------	------	------	------	------

2000

89-94	Models with O.E.M. Number	56101-Z5008 56110-Z5008	I O	83114
-------	---------------------------	----------------------------	--------	-------	------	------	------	------	------	------	------	------

APPLICATION GUIDE

Year	Fitment Notes	OEM#								
			Fleetline\ Gas SLX	Classic\ Ultra\ ProGuard\ Guardian	Max Control\ LTV Severe Duty\ Load Carrier\ Hijackers\ OffGrid Nomads	Steering Dampers\ Steering Stabilizer\ Cab Shock	Fleetline\ Gas SLX	Classic\ Ultra\ ProGuard\ Guardian	Max Control\ LTV Severe Duty\ Load Carrier\ Hijackers\ OffGrid Nomads	Steering Dampers\ Steering Stabilizer\ Cab Shock

UD

UD

2600

89-13	Models with O.E.M. Number	56110-Z5014 56110-Z5017 56101-Z5014 56101-Z5017	 O	83162				
-------	---------------------------	--	-------	-------	------	------	------	--	--	--	--

UD 18HD SERIES

99-10	Models with 22.5" Tires	56110-30Z02 56101-30Z02	 O	G63610				
-------	-------------------------	----------------------------	-------	------	--------	------	------	--	--	--	--

UD 1300

	UD 1300 Models Steer Axle	66400 56110-T8123 56110-T8129	 O	G63432				
--	---------------------------	-------------------------------------	-------	------	--------	------	------	--	--	--	--

UD 1800 SERIES

11-13	Models with 22.5" Tires	56110-30Z02 56101-30Z02	 O	G63610				
95-98	Models with 22.5" Tires	56110-30Z02 56101-30Z02	 O	G63610				

UD 2000 SERIES

95-13	Models with 22.5" Tires	56110-30Z02 56101-30Z02	 O	G63610				
-------	-------------------------	----------------------------	-------	------	--------	------	------	--	--	--	--

UPS TRUCK

UPS TRUCK

VARIOUS

	Models with O.E.M. Number	P117099					
--	---------------------------	---------	--	------	------	------	------	--	--	--	--

WHEELED COACH IND.

WHEELED COACH IND.

	Citimedic models with Ford E350 & E450 Chassis	ASH-1136					
	Citimedic models with Ford E350 & E450 Chassis To 2022	ASH-1154	 O	G63622	58622 77614				

WINNEBAGO

WINNEBAGO

ACCESS

07-13	MotorHomes with Ford E350 or E450 Chassis	8C2Z-18124-D 8C24-18045-DA ASH-1154 AT-163G	 O	G63622	58622 77614				
		8C24-18080-DB ASH-1136 8C2Z-18125-D AT-164G	 O			G63623	58623 77623



ACCESS PREMIER

14	MotorHomes with Ford E350 or E450 Chassis	8C2Z-18124-D 8C24-18045-DA ASH-1154 AT-163G	 O	G63622	58622 77614				
		8C24-18080-DB ASH-1136 8C2Z-18125-D AT-164G	 O			G63623	58623 77623

ADVENTURER

19-24	MotorHomes with Ford F53 Chassis with 24,000 lb GVW to 26,000 lb GVW	ASH-25821 ASH-1161	 O	85006				
-------	--	-----------------------	-------	-------	------	------	------	--	--	--	--

APPLICATION GUIDE

Year	Fitment Notes	OEM#								
			Fleetline\ Gas SLX	Classic\ Ultra\ ProGuard\ Guardian	Max Control\ LTV Severe Duty\ Load Carrier\ HiJackers\ OffGrid Nomads	Steering Dampers\ Steering Stabilizer\ Cab Shock	Fleetline\ Gas SLX	Classic\ Ultra\ ProGuard\ Guardian	Max Control\ LTV Severe Duty\ Load Carrier\ HiJackers\ OffGrid Nomads	Steering Dampers\ Steering Stabilizer\ Cab Shock



WINNEBAGO

WINNEBAGO

ADVENTURER (cont)

19-23	Motorhomes with Ford F-53 Chassis with 16,000 lb GVW to 22,000 lb GVW	ASH-1206 9U94-18080-AA 9U9Z-18125-B AT-621 ASH-25825 ASH-25824 9U9Z-18125-A ASH-1023 ASH-1230 ASH-137 HU9Z-18125-B	OO	83122 89406
	MotorHomes with Ford F53 Chassis with 16,000 lb GVW to 22,000 lb GVW	ASH-1229 ASH-1228 9U94-18045-AA ASH-1205 AT-620 ASH-1022 1C34-18045-AA ASH-294 9U9Z-18124-A ASH-25822 ASH-25823 1C34-18045-JA AT-766	OO	83209
	MotorHomes with Ford F53 Chassis with 24,000 lb GVW to 26,000 lb GVW	ASH-25820 ASH-1162	OO	85005 89430
08-17	MotorHomes with Ford F53 Chassis with 24,000 lb GVW to 26,000 lb GVW	ASH-25821 ASH-1161	OO	85006
		ASH-25820 ASH-1162	OO	85005 89430
06-17	Motorhomes with Ford F-53 Chassis with 16,000 lb GVW to 22,000 lb GVW	ASH-1206 9U94-18080-AA 9U9Z-18125-B AT-621 ASH-25825 ASH-25824 9U9Z-18125-A ASH-1023 ASH-1230 ASH-137 HU9Z-18125-B	OO	83122 89406
92-17	MotorHomes with Ford F53 Chassis with 16,000 lb GVW to 22,000 lb GVW	ASH-1229 ASH-1228 9U94-18045-AA ASH-1205 AT-620 ASH-1022 1C34-18045-AA ASH-294 9U9Z-18124-A ASH-25822 ASH-25823 1C34-18045-JA AT-766	OO	83209
98-11	Models with W20 & W22 Workhorse Motorhome Chassis	24-153249 F4-BE5-B492-HO W0005662 W0006254 24-186629 F4-BE5-A832-MO F4-BE5-F324-HO	OO	85125
04-09	Models with Workhorse W22, & W24 MotorHome Chassis with O.E.M. Number	W0005663 F4-BE5-F325-HO 24-153256	OO	85124
99-04	Motorhomes with Ford F-53 Chassis with 16,000 lb GVW to 22,000 lb GVW	ASH-1206 9U94-18080-AA 9U9Z-18125-B AT-621 ASH-25825 ASH-25824 9U9Z-18125-A ASH-1023 ASH-1230 ASH-137 HU9Z-18125-B	OO	83122 89406

APPLICATION GUIDE

Year	Fitment Notes	OEM#								
			Fleetline\ Gas SLX	Classic\ Ultra\ ProGuard\ Guardian	Max Control\ LTV Severe Duty\ Load Carrier\ Hijackers\ OffGrid Nomads	Steering Dampers\ Steering Stabilizer\ Cab Shock	Fleetline\ Gas SLX	Classic\ Ultra\ ProGuard\ Guardian	Max Control\ LTV Severe Duty\ Load Carrier\ Hijackers\ OffGrid Nomads	Steering Dampers\ Steering Stabilizer\ Cab Shock

WINNEBAGO ASPECT

WINNEBAGO

18-20	MotorHomes with Ford E350 or E450 Chassis	8C2Z-18124-D 8C24-18045-DA ASH-1154 AT-163G			G63622	58622 77614				
		8C24-18080-DB ASH-1136 8C2Z-18125-D AT-164G							G63623	58623 77623
06-17	MotorHomes with Ford E350 or E450 Chassis	8C2Z-18124-D 8C24-18045-DA ASH-1154 AT-163G			G63622	58622 77614				
		8C24-18080-DB ASH-1136 8C2Z-18125-D AT-164G							G63623	58623 77623
05	MotorHomes with Ford E350 or E450 Chassis	8C24-18045-DA			G63622	58622 77614				

CAMBRIA

18-20	MotorHomes with Ford E350 or E450 Chassis	8C2Z-18124-D 8C24-18045-DA ASH-1154 AT-163G			G63622	58622 77614				
		8C24-18080-DB ASH-1136 8C2Z-18125-D AT-164G							G63623	58623 77623
16-17	MotorHomes with Ford E350 or E450 Chassis	8C2Z-18124-D 8C24-18045-DA ASH-1154 AT-163G			G63622	58622 77614				
		8C24-18080-DB ASH-1136 8C2Z-18125-D AT-164G							G63623	58623 77623
09-15	MotorHomes with Ford E350 or E450 Chassis	8C2Z-18124-D 8C24-18045-DA ASH-1154 AT-163G			G63622	58622 77614				
		8C24-18080-DB ASH-1136 8C2Z-18125-D AT-164G							G63623	58623 77623
05-08	MotorHomes with Ford E350 or E450 Chassis	8C2Z-18124-D 8C24-18045-DA ASH-1154 AT-163G			G63622	58622 77614				
		8C24-18080-DB ASH-1136 8C2Z-18125-D AT-164G							G63623	58623 77623



EKKO

21-22	MotorHomes with Ford Transit-350 Chassis				G57816 ⁴⁰					G64177				
-------	--	--	--	--	----------------------	--	--	--	--	--------	--	--	--	--

INTENT

18-20	Motorhome Chassis with 16,000 lb GVW to 18,000 lb GVW	9U9Z-18125-B ASH-25825								83122 89406				
	Motorhome Chassis with 20,500 lb GVW to 22,000 lb GVW	ASH-1206 9U94-18080-AA AT-621 ASH-25824 9U9Z-18125-A ASH-1023 ASH-1230 ASH-137 HU9Z-18125-B								83122 89406				

APPLICATION GUIDE

Year	Fitment Notes	OEM#								
			Fleetline/ Gas SLX	Classic/ Ultra/ ProGuard/ Guardian	Max Control/ LTV Severe Duty/ Load Carrier/ HiJackers/ OffGrid Nomads	Steering Dampers/ Steering Stabilizer/ Cab Shock	Fleetline/ Gas SLX	Classic/ Ultra/ ProGuard/ Guardian	Max Control/ LTV Severe Duty/ Load Carrier/ HiJackers/ OffGrid Nomads	Steering Dampers/ Steering Stabilizer/ Cab Shock

WINNEBAGO

WINNEBAGO

INTENT (cont)

18-20	MotorHomes with Ford F53 Chassis with 16,000 lb GVW to 22,000 lb GVW	ASH-1229 ASH-1228 ASH-1205 ASH-294 ASH-25822 ASH-1022 ASH-25823	 O	83209						
-------	--	---	-------	-------	------	------	------	--	--	--	--	--	--

JOURNEY

02-06	MotorHomes with Freightliner XC Chassis and ADL200 Suspension w/ 20K Rear	16-16873-000 141700131809 16-16736-000							
	MotorHomes with Freightliner XC Chassis and AS120 Front Suspension	16-16874-000 16-16737-000 141700131810	 O	83160	 O	85029

MINNIE

06-20	MotorHomes with Ford E350 or E450 Chassis	8C2Z-18124-D 8C24-18045-DA ASH-1154 AT-163G	 O	G63622	58622 77614						
		8C24-18080-DB ASH-1136 8C2Z-18125-D AT-164G	 O	 O	G63623	58623 77623
00-05	MotorHomes with Ford E350 or E450 Chassis	8C2Z-18124-D 8C24-18045-DA ASH-1154 AT-163G	 O	G63622	58622 77614						
		8C24-18080-DB ASH-1136 8C2Z-18125-D AT-164G	 O	 O	G63623	58623 77623
99	MotorHomes with Ford E350 or E450 Chassis	8C2Z-18124-D 8C24-18045-DA ASH-1154 AT-163G	 O	G63622	58622 77614						
		8C24-18080-DB ASH-1136 8C2Z-18125-D AT-164G	 O	 O	G63623	58623 77623



MINNIE WINNIE

14-24	MotorHomes with Ford E350 or E450 Chassis	8C2Z-18124-D 8C24-18045-DA ASH-1154 AT-163G	 O	G63622	58622 77614						
		8C24-18080-DB ASH-1136 8C2Z-18125-D AT-164G	 O	 O	G63623	58623 77623
00-06	MotorHomes with Ford E350 or E450 Chassis	8C2Z-18124-D 8C24-18045-DA ASH-1154 AT-163G	 O	G63622	58622 77614						
		8C24-18080-DB ASH-1136 8C2Z-18125-D AT-164G	 O	 O	G63623	58623 77623

OUTLOOK

19-21	MotorHomes with Ford E350 or E450 Chassis	8C2Z-18124-D 8C24-18045-DA ASH-1154 AT-163G	 O	G63622	58622 77614						
		8C24-18080-DB ASH-1136 8C2Z-18125-D AT-164G	 O	 O	G63623	58623 77623
11-18	MotorHomes with Ford E350 or E450 Chassis	8C2Z-18124-D 8C24-18045-DA ASH-1154 AT-163G	 O	G63622	58622 77614						

APPLICATION GUIDE

Year	Fitment Notes	OEM#								
			Fleetline/ Gas SLX	Classic/ Ultra/ ProGuard/ Guardian	Max Control/ LTV Severe Duty/ Load Carrier/ Hijackers/ OffGrid Nomads	Steering Dampers/ Steering Stabilizer/ Cab Shock	Fleetline/ Gas SLX	Classic/ Ultra/ ProGuard/ Guardian	Max Control/ LTV Severe Duty/ Load Carrier/ Hijackers/ OffGrid Nomads	Steering Dampers/ Steering Stabilizer/ Cab Shock

WINNEBAGO

WINNEBAGO

OUTLOOK (cont)

11-18	MotorHomes with Ford E350 or E450 Chassis	8C24-18080-DB ASH-1136 8C2Z-18125-D AT-164G											
06-10	MotorHomes with Ford E350 or E450 Chassis	8C2Z-18124-D 8C24-18045-DA ASH-1154 AT-163G			G63622	58622 77614							
		8C24-18080-DB ASH-1136 8C2Z-18125-D AT-164G											



SIGHTSEER

11-17	Motorhome Chassis with 16,000 lb GVW to 18,000 lb GVW	9U9Z-18125-B ASH-25825											
	Motorhome Chassis with 20,500 lb GVW to 22,000 lb GVW	ASH-1206 9U94-18080-AA AT-621 ASH-25824 9U9Z-18125-A ASH-1023 ASH-1230 ASH-137 HU9Z-18125-B											
02-17	MotorHomes with Ford F53 Chassis with 16,000 lb GVW to 22,000 lb GVW	ASH-1229 ASH-1228 9U94-18045-AA ASH-1205 AT-620 ASH-1022 1C34-18045-AA ASH-294 9U9Z-18124-A ASH-25822 ASH-25823 1C34-18045-JA AT-766	83209										
08-09	Motorhome Chassis with 16,000 lb GVW to 18,000 lb GVW	9U9Z-18125-B ASH-25825											
06-09	Motorhome Chassis with 20,500 lb GVW to 22,000 lb GVW	ASH-1206 9U94-18080-AA AT-621 ASH-25824 9U9Z-18125-A ASH-1023 ASH-1230 ASH-137 HU9Z-18125-B											
02-04	Motorhome Chassis with 20,500 lb GVW to 22,000 lb GVW	ASH-1206 9U94-18080-AA AT-621 ASH-25824 9U9Z-18125-A ASH-1023 ASH-1230 ASH-137 HU9Z-18125-B											

SPIRIT

16-22	MotorHomes with Ford E350 or E450 Chassis	8C2Z-18124-D 8C24-18045-DA ASH-1154 AT-163G											
		8C24-18080-DB ASH-1136 8C2Z-18125-D AT-164G											
08-15	MotorHomes with Ford E350 or E450 Chassis	8C2Z-18124-D 8C24-18045-DA ASH-1154 AT-163G			G63622	58622 77614							
		8C24-18080-DB ASH-1136 8C2Z-18125-D AT-164G											

APPLICATION GUIDE

Year	Fitment Notes	OEM#								
			Fleetline\ Gas SLX	Classic\ Ultra\ ProGuard\ Guardian	Max Control\ LTV Severe Duty\ Load Carrier\ HiJackers\ OffGrid Nomads	Steering Dampers\ Steering Stabilizer\ Cab Shock	Fleetline\ Gas SLX	Classic\ Ultra\ ProGuard\ Guardian	Max Control\ LTV Severe Duty\ Load Carrier\ HiJackers\ OffGrid Nomads	Steering Dampers\ Steering Stabilizer\ Cab Shock

WINNEBAGO

WINNEBAGO

SPRIT (cont)

00-07	MotorHomes with Ford E350 or E450 Chassis	8C2Z-18124-D 8C24-18045-DA ASH-1154 AT-163G	 O	G63622	58622 77614
		8C24-18080-DB ASH-1136 8C2Z-18125-D AT-164G	 O	G63623	58623 77623



SUNOVA

16-17	Motorhome Chassis with 16,000 lb GVW to 18,000 lb GVW	9U9Z-18125-B ASH-25825	 O
	Motorhome Chassis with 20,500 lb GVW to 22,000 lb GVW	ASH-1206 9U94-18080-AA AT-621 ASH-25824 9U9Z-18125-A ASH-1023 ASH-1230 ASH-137 HU9Z-18125-B	 O
	MotorHomes with Ford F53 Chassis with 16,000 lb GVW to 22,000 lb GVW	ASH-1229 ASH-1228 9U94-18045-AA ASH-1205 AT-620 ASH-1022 1C34-18045-AA ASH-294 9U9Z-18124-A ASH-25822 ASH-25823 1C34-18045-JA AT-766	 O	83209
06-07	Motorhome Chassis with 20,500 lb GVW to 22,000 lb GVW	ASH-1206 9U94-18080-AA AT-621 ASH-25824 9U9Z-18125-A ASH-1023 ASH-1230 ASH-137 HU9Z-18125-B	 O
02-07	MotorHomes with Ford F53 Chassis with 16,000 lb GVW to 22,000 lb GVW	ASH-1229 ASH-1228 9U94-18045-AA ASH-1205 AT-620 ASH-1022 1C34-18045-AA ASH-294 9U9Z-18124-A ASH-25822 ASH-25823 1C34-18045-JA AT-766	 O	83209
02-04	Motorhome Chassis with 20,500 lb GVW to 22,000 lb GVW	ASH-1206 9U94-18080-AA AT-621 ASH-25824 9U9Z-18125-A ASH-1023 ASH-1230 ASH-137 HU9Z-18125-B	 O

SUNSTAR

16-24	MotorHomes with Ford F53 Chassis with 24,000 lb GVW to 26,000 lb GVW	ASH-25821 ASH-1161	 O	85006
16-22	Motorhome Chassis with 16,000 lb GVW to 18,000 lb GVW	9U9Z-18125-B ASH-25825	 O	83122 89406

APPLICATION GUIDE

Year	Fitment Notes	OEM#								
			Fleetline\ Gas SLX	Classic\ Ultra\ ProGuard\ Guardian	Max Control\ LTV Severe Duty\ Load Carrier\ Hijackers\ OffGrid Nomads	Steering Dampers\ Steering Stabilizer\ Cab Shock	Fleetline\ Gas SLX	Classic\ Ultra\ ProGuard\ Guardian	Max Control\ LTV Severe Duty\ Load Carrier\ Hijackers\ OffGrid Nomads	Steering Dampers\ Steering Stabilizer\ Cab Shock

WINNEBAGO

WINNEBAGO

SUNSTAR (cont)

16-22	Motorhome Chassis with 20,500 lb GVW to 22,000 lb GVW	ASH-1206 9U94-18080-AA AT-621 ASH-25824 9U9Z-18125-A ASH-1023 ASH-1230 ASH-137 HU9Z-18125-B	oio	83122 89406	oio	oio	oio	oio	oio	oio	oio	oio	oio	
	MotorHomes with Ford F53 Chassis with 16,000 lb GVW to 22,000 lb GVW	ASH-1229 ASH-1228 9U94-18045-AA ASH-1205 AT-620 ASH-1022 1C34-18045-AA ASH-294 9U9Z-18124-A ASH-25822 ASH-25823 1C34-18045-JA AT-766	oio	83209	oio	oio	oio	oio	oio	oio	oio	oio	oio	oio
	MotorHomes with Ford F53 Chassis with 24,000 lb GVW to 26,000 lb GVW	ASH-25820 ASH-1162	oio	85005 89430	oio	oio	oio	oio	oio	oio	oio	oio	oio	oio
02-04	Motorhome Chassis with 20,500 lb GVW to 22,000 lb GVW	ASH-1206 9U94-18080-AA AT-621 ASH-25824 9U9Z-18125-A ASH-1023 ASH-1230 ASH-137 HU9Z-18125-B	oio	83122 89406	oio	oio	oio	oio	oio	oio	oio	oio	oio	
	MotorHomes with Ford F53 Chassis with 16,000 lb GVW to 22,000 lb GVW	ASH-1229 ASH-1228 9U94-18045-AA ASH-1205 AT-620 ASH-1022 1C34-18045-AA ASH-294 9U9Z-18124-A ASH-25822 ASH-25823 1C34-18045-JA AT-766	oio	83209	oio	oio	oio	oio	oio	oio	oio	oio	oio	

SUNSTAR LX

16-18	Motorhome Chassis with 16,000 lb GVW to 18,000 lb GVW	9U9Z-18125-B ASH-25825	oio	83122 89406	oio	oio	oio	oio	oio	oio	oio	oio	oio
	Motorhome Chassis with 20,500 lb GVW to 22,000 lb GVW	ASH-1206 9U94-18080-AA AT-621 ASH-25824 9U9Z-18125-A ASH-1023 ASH-1230 ASH-137 HU9Z-18125-B	oio	83122 89406	oio	oio	oio	oio	oio	oio	oio	oio	oio
	MotorHomes with Ford F53 Chassis with 16,000 lb GVW to 22,000 lb GVW	ASH-1229 ASH-1228 ASH-1205 ASH-25822 ASH-1022 ASH-25823	oio	83209	oio	oio	oio	oio	oio	oio	oio	oio	oio



TOUR

06	MotorHomes with Freightliner XC Chassis and ADL200 Suspension w/ 20K Rear	16-16873-000 141700131809 16-16736-000	oio	85029	oio	oio	oio	oio	oio	oio	oio	oio	oio
	MotorHomes with Freightliner XC Chassis and AS120 Front Suspension	16-16874-000 16-16737-000 141700131810	oio	83160	oio	oio	oio	oio	oio	oio	oio	oio	oio

VECTRA

06	MotorHomes with Freightliner XC Chassis and ADL200 Suspension w/ 20K Rear	16-16873-000 141700131809 16-16736-000	oio	85029	oio	oio	oio	oio	oio	oio	oio	oio	oio
----	---	--	-----	-------	-----	-----	-----	-----	-----	-----	-----	-----	-----

APPLICATION GUIDE

Year	Fitment Notes	OEM#								
			Fleetline\ Gas SLX	Classic\ Ultra\ ProGuard\ Guardian	Max Control\ LTV Severe Duty\ Load Carrier\ HiJackers\ OffGrid Nomads	Steering Dampers\ Steering Stabilizer\ Cab Shock	Fleetline\ Gas SLX	Classic\ Ultra\ ProGuard\ Guardian	Max Control\ LTV Severe Duty\ Load Carrier\ HiJackers\ OffGrid Nomads	Steering Dampers\ Steering Stabilizer\ Cab Shock

WINNEBAGO

WINNEBAGO

VECTRA (cont)

06	MotorHomes with Freightliner XC Chassis and AS120 Front Suspension	16-16874-000 16-16737-000 141700131810	OO	83160
----	--	--	----	-------	------	------	------	------	------	------



VISTA

08-24	MotorHomes with Ford F53 Chassis with 24,000 lb GVW to 26,000 lb GVW	ASH-25821 ASH-1161	OO	85006
11-22	Motorhome Chassis with 16,000 lb GVW to 18,000 lb GVW	9U9Z-18125-B ASH-25825		OO	83122 89406
	Motorhome Chassis with 20,500 lb GVW to 22,000 lb GVW	ASH-1206 9U94-18080-AA AT-621 ASH-25824 9U9Z-18125-A ASH-1023 ASH-1230 ASH-137 HU9Z-18125-B		OO	83122 89406
08-22	MotorHomes with Ford F53 Chassis with 24,000 lb GVW to 26,000 lb GVW	ASH-25820 ASH-1162		OO	85005 89430
07-22	MotorHomes with Ford F53 Chassis with 16,000 lb GVW to 22,000 lb GVW	ASH-1229 ASH-1228 9U94-18045-AA ASH-1205 AT-620 ASH-1022 1C34-18045-AA ASH-294 9U9Z-18124-A ASH-25822 ASH-25823 1C34-18045-JA AT-766	OO	83209
08-09	Motorhome Chassis with 16,000 lb GVW to 18,000 lb GVW	9U9Z-18125-B ASH-25825		OO	83122 89406
07-09	Motorhome Chassis with 20,500 lb GVW to 22,000 lb GVW	ASH-1206 9U94-18080-AA AT-621 ASH-25824 9U9Z-18125-A ASH-1023 ASH-1230 ASH-137 HU9Z-18125-B		OO	83122 89406
02-04	Motorhome Chassis with 20,500 lb GVW to 22,000 lb GVW	ASH-1206 9U94-18080-AA AT-621 ASH-25824 9U9Z-18125-A ASH-1023 ASH-1230 ASH-137 HU9Z-18125-B		OO	83122 89406
	MotorHomes with Ford F53 Chassis with 16,000 lb GVW to 22,000 lb GVW	ASH-1229 ASH-1228 9U94-18045-AA ASH-1205 AT-620 ASH-1022 1C34-18045-AA ASH-294 9U9Z-18124-A ASH-25822 ASH-25823 1C34-18045-JA AT-766	OO	83209

VISTA LX

16-18	Motorhome Chassis with 16,000 lb GVW to 18,000 lb GVW	9U9Z-18125-B ASH-25825		OO	83122 89406
-------	---	---------------------------	--	------	------	------	------	----	----------------	------

APPLICATION GUIDE

Year	Fitment Notes	OEM#								
			Fleetline\ Gas SLX	Classic\ Ultra\ ProGuard\ Guardian	Max Control\ LTV Severe Duty\ Load Carrier\ Hijackers\ OffGrid Nomads	Steering Dampers\ Steering Stabilizer\ Cab Shock	Fleetline\ Gas SLX	Classic\ Ultra\ ProGuard\ Guardian	Max Control\ LTV Severe Duty\ Load Carrier\ Hijackers\ OffGrid Nomads	Steering Dampers\ Steering Stabilizer\ Cab Shock

WINNEBAGO

WINNEBAGO

VISTA LX (cont)

16-18	Motorhome Chassis with 20,500 lb GVW to 22,000 lb GVW	ASH-1206 9U94-18080-AA AT-621 ASH-25824 9U9Z-18125-A ASH-1023 ASH-1230 ASH-137 HU9Z-18125-B	OIO	83122 89406							
	MotorHomes with Ford F53 Chassis with 16,000 lb GVW to 22,000 lb GVW	ASH-1229 ASH-1228 ASH-1205 ASH-25822 ASH-1022 ASH-25823	OIO	83209							

WORKHORSE

WORKHORSE

VARIOUS

	Models with O.E.M. Number	W0011635	OIO	83221							
		W0011636	OIO								
	Models with RSAS Rear Suspension	7805-X-1012	OIO	85919							
	Step Van Models with O.E.M. Number	W0007365	OIO								
	UFO Motorhome Chassis with Hendrickson Softek Front Suspension	66153-002 F4-BE5-C832-MO	OIO	83124							

W20

04-09	Models with O.E.M. Number	W0005663 F4-BE5-F325-HO 24-153256	OIO	85124							
01-09	All	24-153249 F4-BE5-B492-HO W0005662 W0006254 24-186629 F4-BE5-A832-MO F4-BE5-F324-HO	OIO	85125							

W22

04-09	Models with O.E.M. Number	W0005663 F4-BE5-F325-HO 24-153256	OIO	85124							
01-09	All	24-153249 F4-BE5-B492-HO W0005662 W0006254 24-186629 F4-BE5-A832-MO F4-BE5-F324-HO	OIO	85125							

W24

04-09	Models with O.E.M. Number	W0005663 F4-BE5-F325-HO 24-153256	OIO	85124							
01-09	MotorHome Chassis with O.E.M. Number	24-153249 F4-BE5-B492-HO W0005662 W0006254 24-186629 F4-BE5-A832-MO F4-BE5-F324-HO	OIO	85125							

WORLD TRANS BUS CO.

WORLD TRANS BUS CO.

VARIOUS

	E & G Series Commercial buses on Ford E350 or E450 Chassis	ASH-1154	OIO		G63622	58622 77614					
		ASH-1136	OIO					G63623	58623 77623		

APPLICATION GUIDE

Year	Fitment Notes	OEM#								
			Fleetline\ Gas SLX	Classic\ Ultra\ ProGuard\ Guardian	Max Control\ LTV Severe Duty\ Load Carrier\ HiJackers\ OffGrid Nomads	Steering Dampers\ Steering Stabilizer\ Cab Shock	Fleetline\ Gas SLX	Classic\ Ultra\ ProGuard\ Guardian	Max Control\ LTV Severe Duty\ Load Carrier\ HiJackers\ OffGrid Nomads	Steering Dampers\ Steering Stabilizer\ Cab Shock

XOS

XOS

ADDITIONAL O.E.M. INTERCHANGES

	Medium Duty Electric Trucks with Hendrickson Softek Suspension (10K Capacity)	58913-009L 58913-009	O O	85959		
	Medium Duty Trucks With Hendrickson HTS Suspension (16K Capacity)	60665-025 60665-025L		O O	85036 89405

Numerical listing

Numerical listing

Shock	POP	Alternative No.	MTG Acc. Supplied
Pos.	Year	Application	
Steering Dampers			
14072	A		
F	20-24	FORD F-600 SUPER DUTY All	
F	08-24	PICKUP, F-450 SUPERDUTY 4 X 4	
F	08-24	PICKUP, F-550 SUPERDUTY 4 X 4	
646218	N		
	11-23	HENDRICKSON SCT10	
	11-23	SCT13	
Front Load Carrier			
34076	A		140780
F	10-19	FORD VAN 1 TON, ECONOLINE / CLUB WAGON / SUPERDUTY All	
Rear Load Carrier			
43048	A		
R	68-72	INTERNATIONAL M1100 / M1200 All	
R	69	M1400 All	
43167	A		
R	88-97	FORD F-SUPER DUTY All Quad Suspension; Rearward of Front Axle	
R	97	PICKUP, F-450 SUPERDUTY All Quad Suspension; Rearward of Front Axle	
HiJackers			
49178	B		140126,141099
R	21-24	FORD VAN 1 TON, ECONOLINE / CLUB WAGON / SUPERDUTY All	
R	10-19	VAN 1 TON, ECONOLINE / CLUB WAGON / SUPERDUTY All	
49310	D		140788,141099
R	68-72	INTERNATIONAL M1100 / M1200 All	
R	69	M1400 All	
LTV Severe Duty			
58622	W		142617
F	17-24	BERKSHIRE COACH ULTRA 24	
F	17-24	ULTRA 28	
F	92-24	BLUE BIRD MICROBIRD TYPE A SCHOOL BUS	
F		CHAMPION BUS INC. AMERICAN COACH	
F		CHALLENGER	
F		CRUSADER	
F		LF TRANSPORT	
F	03-24	COACH HOUSE PLATINUM All Motorhomes with Ford E450 Chassis	
F	23-24	PLATINUM IV All Motorhomes with Ford E450 Chassis	
F		COACHMEN CATALINA	
F	20-22	CONCORD	
F	04-06	CONCORD	
F	23-24	CONCORD All MotorHomes with Ford E350 or E450 Chassis	
F	07-19	CONCORD All MotorHomes with Ford E350 or E450 Chassis	
F	04-08	FREEDOM EXPRESS	
F	09	FREEDOM EXPRESS All MotorHomes with Ford E350 or E450 Chassis	
F	03-07	FREELANDER	
F	08-24	FREELANDER All MotorHomes with Ford E350 or E450 Chassis	
F	10	LEPRECHAUN	
F	03-07	LEPRECHAUN	
F	11-24	LEPRECHAUN All MotorHomes with Ford E350 or E450 Chassis	
F	08-09	LEPRECHAUN All MotorHomes with Ford E350 or E450 Chassis	
F	98-03	PATHFINDER	
F	99-06	SANTARA	
F		COLLINS BUS CORP. VARIOUS	
F		DIAMOND COACH SHUTTLE BUSES	
F	92-09	DUTCHMEN RV CLASS C MOTORHOMES	
F	15-20	JAMBOREE	
F	92-17	DYNAMAX CORP ISATA 4	
F	18-20	ISATA 4 All MotorHomes with Ford E350 or E450 Chassis	
F		ELDORADO NATIONAL ADVANTAGE	
F		AEROLITE	
F		AEROTECH	
F	17	ENTEGR COACH ESTEEM	
F	18-24	ESTEEM All MotorHomes with Ford E350 or E450 Chassis	

Shock	POP	Alternative No.	MTG Acc. Supplied
Pos.	Year	Application	
58622	W (cont)		142617
F	17	ODYSSEY	
F	26	ODYSSEY 24B With Ford E-450 Super Duty	
F	26	ODYSSEY 30Z With Ford E-450 Super Duty	
F	18-24	ODYSSEY All MotorHomes with Ford E350 or E450 Chassis	
F	23-24	ODYSSEY SE All MotorHomes with Ford E450 Chassis	
F		FEDERAL COACH VARIOUS	
F	20	FLEETWOOD JAMBOREE	
F	14-16	JAMBOREE	
F	99-07	JAMBOREE	
F	17-19	JAMBOREE All MotorHomes with Ford E350 or E450 Chassis	
F	08-13	JAMBOREE All MotorHomes with Ford E350 or E450 Chassis	
F	19-20	SURGE	
F	18	SURGE All MotorHomes with Ford E350 or E450 Chassis	
F	14-16	TIOGA	
F	99-07	TIOGA	
F	08-13	TIOGA All MotorHomes with Ford E350 or E450 Chassis	
F	00-02	FORD E-450 ECONOLINE SUPER DUTY All	
F	21-26	VAN 1 TON, ECONOLINE / CLUB WAGON / SUPERDUTY All	
F	03-19	VAN 1 TON, ECONOLINE / CLUB WAGON / SUPERDUTY All	
F		FOREST RIVER ALL AMERICAN	
F	20	FORESTER	
F	04-19	FORESTER All MotorHomes with Ford E350 or E450 Chassis	
F	15-18	FORESTER GTS All MotorHomes with Ford E350 or E450 Chassis	
F	03-15	LEXINGTON All MotorHomes with Ford E350 or E450 Chassis	
F	21-24	SOLERA All MotorHomes with Ford E350 or E450 Chassis	
F	10-15	SOLERA All MotorHomes with Ford E350 or E450 Chassis	
F	23	SUNSEEKER	
F	99-06	SUNSEEKER	
F	07-22	SUNSEEKER All MotorHomes with Ford E350 or E450 Chassis	
F	19-20	SUNSEEKER GTS	
F	15-18	SUNSEEKER GTS All MotorHomes with Ford E350 or E450 Chassis	
F	99-09	GEORGIE BOY MANUFACTURING CLASS C MOTORHOMES	
F		GLAVAL BUS CO. VARIOUS	
F		GOSHEN COACH VARIOUS	
F		GRECH MOTORS VARIOUS	
F	02-15	GULF STREAM BT CRUISER	
F	16-24	BT CRUISER All MotorHomes with Ford E350 or E450 Chassis	
F	99-06	CAVALIER	
F	12-15	CONQUEST	
F	93-01	CONQUEST	
F	16-24	CONQUEST All MotorHomes with Ford E350 or E450 Chassis	
F	02-11	CONQUEST All MotorHomes with Ford E350 or E450 Chassis	
F	10-11	CONQUEST SPORT All MotorHomes with Ford E350 or E450 Chassis	
F	01-02	CONQUEST SPORT All MotorHomes with Ford E350 or E450 Chassis	
F	00-11	INDEPENDENCE All MotorHomes with Ford E350 or E450 Chassis	
F	10-11	MONTAJ All MotorHomes with Ford E350 or E450 Chassis	
F	00-08	ULTRA	
F	02-04	YELLOWSTONE	
F	05-11	YELLOWSTONE All MotorHomes with Ford E350 or E450 Chassis	
F	19	HOLIDAY RAMBLER ALTERA	
F	18	ALTERA All MotorHomes with Ford E450 Chassis	
F	08	ATLANTIS	
F	06	ATLANTIS	
F	99-01	ATLANTIS	
F	09-10	ATLANTIS All MotorHomes with Ford E450 Chassis	
F	07	ATLANTIS All MotorHomes with Ford E450 Chassis	
F	02-05	ATLANTIS All MotorHomes with Ford E450 Chassis	
F	19	AUGUSTA All MotorHomes with Ford E450 Chassis	
F	15-16	AUGUSTA All MotorHomes with Ford E450 Chassis	

Shock	POP	Alternative No.	MTG Acc. Supplied
Pos.	Year	Application	
58622	W (cont)		142617
F	11	AUGUSTA All MotorHomes with Ford E450 Chassis	
F	08-09	AUGUSTA All MotorHomes with Ford E450 Chassis	
F	12-13	AUGUSTA B+ All MotorHomes with Ford E450 Chassis	
F	10	AUGUSTA B+ All MotorHomes with Ford E450 Chassis	
F	07	AUGUSTA B+ All MotorHomes with Ford E450 Chassis	
F	16	AUGUSTA LX All MotorHomes with Ford E450 Chassis	
F	07-10	AUGUSTA SPORT All MotorHomes with Ford E350 Chassis	
F	07-09	AUGUSTA TOURING SEDAN All MotorHomes with Ford E350 Chassis	
F	17-18	VESTA All MotorHomes with Ford E450 Chassis	
F	01-20	ITASCA CLASS C MOTORHOMES	
F	03-06	JAYCO ESCAPEE All MotorHomes with Ford E350 or E450 Chassis	
F	02-06	GRANITE RIDGE All MotorHomes with Ford E350 or E450 Chassis	
F	26	GREYHAWK 29MV With Ford E-450 Super Duty	
F	02-24	GREYHAWK All MotorHomes with Ford E450 Chassis	
F	07-24	MELBOURNE All MotorHomes with Ford E350 or E450 Chassis	
F	13-24	REDHAWK All MotorHomes with Ford E450 Chassis	
F	25	REDHAWK 30Z	
F	26	REDHAWK 31FF	
F	26	REDHAWK SE All With Ford E-350 Super Duty	
F	18-24	REDHAWK SE All MotorHomes with Ford E450 Chassis	
F		KRYSTAL BUS VARIOUS	
F		LGE COACHWORKS VARIOUS	
F	11-12	NEXUS CLASS C MOTORHOMES	
F	11-24	PHANTOM All MotorHomes with Ford E350 or E450 Chassis	
F	20-24	TRIUMPH All MotorHomes with Ford E350 or E450 Chassis	
F	24	VIPER 29V MotorHomes with Ford E350 or E450 Chassis	
F	11-23	VIPER All MotorHomes with Ford E350 or E450 Chassis	
F	00-23	PHOENIX CRUISER All MotorHomes with Ford E350 or E450 Chassis	
F		SHASTA RV ALL MODELS	
F		STARCRAFT BUS CO. E350 & E450 FORD CHASSIS MODELS	
F	92-22	THOMAS TYPE A SCHOOL BUS	
F	26	THOR MOTOR COACH AXIS 26.2 With Ford E-450 Super Duty	
F	14-24	AXIS All MotorHomes with Ford E350 or E450 Chassis	
F	11-24	CHATEAU All MotorHomes with Ford E350 or E450 Chassis	
F	11-12	CHATEAU CITATION All MotorHomes with Ford E350 or E450 Chassis	
F	12-16	CITATION All MotorHomes with Ford E350 or E450 Chassis	
F	22-24	ECHELON All MotorHomes with Ford E350 or E450 Chassis	
F	11-24	FOUR WINDS All MotorHomes with Ford E350 or E450 Chassis	
F	25	FOUR WINDS 282	
F	12-24	FREEDOM ELITE All MotorHomes with Ford E350 or E450 Chassis	
F	11-23	OUTLAW All MotorHomes with Ford E350 or E450 Chassis	
F	26	PASADENA All SE19 Submodel; with Ford E=450 Super Duty	
F	16-24	QUANTUM All MotorHomes with Ford E350 or E450 Chassis	
F	25	VEGAS 24.1 MotorHomes with Ford E350 or E450 Chassis	
F	14-24	VEGAS All MotorHomes with Ford E350 or E450 Chassis	
F		TURTLETOP BUS VARIOUS	
F		WHEELED COACH IND. VARIOUS	
F	07-13	WINNEBAGO ACCESS All MotorHomes with Ford E350 or E450 Chassis	
F	14	ACCESS PREMIER All MotorHomes with Ford E350 or E450 Chassis	
F	18-20	ASPECT	

Numerical listing

Shock	POP	Alternative No.	MTG Acc. Supplied
Pos.	Year	Application	
58622	W	(cont)	142617
F	05-17	ASPECT	All MotorHomes with Ford E350 or E450 Chassis
F	18-20	CAMBRIA	
F	09-15	CAMBRIA	
F	16-17	CAMBRIA	All MotorHomes with Ford E350 or E450 Chassis
F	05-08	CAMBRIA	All MotorHomes with Ford E350 or E450 Chassis
F	06-20	MINNIE	
F	99	MINNIE	
F	00-05	MINNIE	All MotorHomes with Ford E350 or E450 Chassis
F	14-24	MINNIE WINNIE	All MotorHomes with Ford E350 or E450 Chassis
F	00-06	MINNIE WINNIE	All MotorHomes with Ford E350 or E450 Chassis
F	11-18	OUTLOOK	
F	19-21	OUTLOOK	All MotorHomes with Ford E350 or E450 Chassis
F	06-10	OUTLOOK	All MotorHomes with Ford E350 or E450 Chassis
F	08-15	SPIRIT	
F	16-22	SPIRIT	All MotorHomes with Ford E350 or E450 Chassis
F	00-07	SPIRIT	All MotorHomes with Ford E350 or E450 Chassis
F		WORLD TRANS BUS CO.	VARIOUS
58623	D		142617
R	17-24	BERKSHIRE COACH	ULTRA 24
R	17-24	ULTRA	28
R	92-24	BLUE BIRD	MICROBIRD TYPE A SCHOOL BUS
R		CHAMPION BUS INC.	AMERICAN COACH
R		CHALLENGER	
R		CRUSADER	
R		LF TRANSPORT	
R	03-24	COACH HOUSE	PLATINUM All Motorhomes with Ford E450 Chassis
R	23-24	PLATINUM IV	All Motorhomes with Ford E450 Chassis
R		COACHMEN	CATALINA
R	20-22	CONCORD	
R	04-06	CONCORD	
R	23-24	CONCORD	All MotorHomes with Ford E350 or E450 Chassis
R	07-19	CONCORD	All MotorHomes with Ford E350 or E450 Chassis
R	04-08	FREEDOM EXPRESS	
R	09	FREEDOM EXPRESS	All MotorHomes with Ford E350 or E450 Chassis
R	03-07	FREELANDER	
R	08-24	FREELANDER	All MotorHomes with Ford E350 or E450 Chassis
R	10	LEPRECHAUN	
R	03-07	LEPRECHAUN	
R	11-24	LEPRECHAUN	All MotorHomes with Ford E350 or E450 Chassis
R	08-09	LEPRECHAUN	All MotorHomes with Ford E350 or E450 Chassis
R	98-03	PATHFINDER	
R	99-06	SANTARA	
R		COLLINS BUS CORP.	VARIOUS
R		DIAMOND COACH	SHUTTLE BUSES
R	92-09	DUTCHMEN RV	CLASS C MOTORHOMES
R	15-20	JAMBOREE	
R	92-17	DYNAMAX CORP	ISATA 4
R	18-20	ISATA 4	All MotorHomes with Ford E350 or E450 Chassis
R		ELDORADO NATIONAL	ADVANTAGE
R		AEROLITE	
R		AEROTECH	
R	17	ENTEGRA COACH	ESTEEM
R	18-24	ESTEEM	All MotorHomes with Ford E350 or E450 Chassis
R	17	ODYSSEY	
R	26	ODYSSEY	24B With Ford E-450 Super Duty
R	26	ODYSSEY	30Z With Ford E-450 Super Duty
R	18-24	ODYSSEY	All MotorHomes with Ford E350 or E450 Chassis
R	23-24	ODYSSEY SE	All MotorHomes with Ford E450 Chassis
R		FEDERAL COACH	VARIOUS
R	20	FLEETWOOD	JAMBOREE
R	14-16	JAMBOREE	
R	99-07	JAMBOREE	

LTV Severe Duty

Shock	POP	Alternative No.	MTG Acc. Supplied
Pos.	Year	Application	
58623	D	(cont)	142617
R	17-19	JAMBOREE	All MotorHomes with Ford E350 or E450 Chassis
R	08-13	JAMBOREE	All MotorHomes with Ford E350 or E450 Chassis
R	19-20	SURGE	
R	18	SURGE	All MotorHomes with Ford E350 or E450 Chassis
R	14-16	TIOGA	
R	99-07	TIOGA	
R	08-13	TIOGA	All MotorHomes with Ford E350 or E450 Chassis
R	00-02	FORD E-450	ECONOLINE SUPER DUTY All
R	21-26	VAN 1 TON,	ECONOLINE / CLUB WAGON / SUPERDUTY All
R	03-19	VAN 1 TON,	ECONOLINE / CLUB WAGON / SUPERDUTY All
R	20	FORESTER	
R	04-19	FORESTER	All MotorHomes with Ford E350 or E450 Chassis
R	15-18	FORESTER GTS	All MotorHomes with Ford E350 or E450 Chassis
R	03-15	LEXINGTON	All MotorHomes with Ford E350 or E450 Chassis
R	21-24	SOLERA	All MotorHomes with Ford E350 or E450 Chassis
R	10-15	SOLERA	All MotorHomes with Ford E350 or E450 Chassis
R	23	SUNSEEKER	
R	99-06	SUNSEEKER	
R	07-22	SUNSEEKER	All MotorHomes with Ford E350 or E450 Chassis
R	19-20	SUNSEEKER GTS	
R	15-18	SUNSEEKER GTS	All MotorHomes with Ford E350 or E450 Chassis
R	99-09	GEORGIE BOY MANUFACTURING	CLASS C MOTORHOMES
R		GLAVAL BUS CO.	VARIOUS
R		GOSHEN COACH	VARIOUS
R		GRECH MOTORS	VARIOUS
R	02-15	GULF STREAM	BT CRUISER
R	16-24	BT CRUISER	All MotorHomes with Ford E350 or E450 Chassis
R	99-06	CAVALIER	
R	12-15	CONQUEST	
R	93-01	CONQUEST	
R	16-24	CONQUEST	All MotorHomes with Ford E350 or E450 Chassis
R	02-11	CONQUEST	All MotorHomes with Ford E350 or E450 Chassis
R	10-11	CONQUEST SPORT	All MotorHomes with Ford E350 or E450 Chassis
R	01-02	CONQUEST SPORT	All MotorHomes with Ford E350 or E450 Chassis
R	00-11	INDEPENDENCE	All MotorHomes with Ford E350 or E450 Chassis
R	10-11	MONTAJ	All MotorHomes with Ford E350 or E450 Chassis
R	00-08	ULTRA	
R	02-04	YELLOWSTONE	
R	05-11	YELLOWSTONE	All MotorHomes with Ford E350 or E450 Chassis
R	19	HOLIDAY RAMBLER	ALTERA
R	18	ALTERA	All MotorHomes with Ford E450 Chassis
R	08	ATLANTIS	
R	06	ATLANTIS	
R	99-01	ATLANTIS	
R	09-10	ATLANTIS	All MotorHomes with Ford E450 Chassis
R	07	ATLANTIS	All MotorHomes with Ford E450 Chassis
R	02-05	ATLANTIS	All MotorHomes with Ford E450 Chassis
R	19	AUGUSTA	All MotorHomes with Ford E450 Chassis
R	15-16	AUGUSTA	All MotorHomes with Ford E450 Chassis
R	11	AUGUSTA	All MotorHomes with Ford E450 Chassis
R	08-09	AUGUSTA	All MotorHomes with Ford E450 Chassis
R	12-13	AUGUSTA B+	All MotorHomes with Ford E450 Chassis
R	10	AUGUSTA B+	All MotorHomes with Ford E450 Chassis
R	07	AUGUSTA B+	All MotorHomes with Ford E450 Chassis
R	16	AUGUSTA LX	All MotorHomes with Ford E450 Chassis

Numerical listing

Shock	POP	Alternative No.	MTG Acc. Supplied
Pos.	Year	Application	
58623	D	(cont)	142617
R	07-10	AUGUSTA SPORT	All MotorHomes with Ford E350 Chassis
R	07-09	AUGUSTA TOURING SEDAN	All MotorHomes with Ford E350 Chassis
R	17-18	VESTA	All MotorHomes with Ford E450 Chassis
R	01-20	ITASCA CLASS C	MOTORHOMES
R	03-06	JAYCO ESCAPE	All MotorHomes with Ford E350 or E450 Chassis
R	02-06	GRANITE RIDGE	All MotorHomes with Ford E350 or E450 Chassis
R	26	GREYHAWK	29MV With Ford E-450 Super Duty
R	02-24	GREYHAWK	All MotorHomes with Ford E450 Chassis
R	07-24	MELBOURNE	All MotorHomes with Ford E350 or E450 Chassis
R	13-24	REDHAWK	All MotorHomes with Ford E450 Chassis
R	25	REDHAWK 30Z	
R	26	REDHAWK 31FF	
R	26	REDHAWK SE	All With Ford E-350 Super Duty
R	18-24	REDHAWK SE	All MotorHomes with Ford E450 Chassis
R		KRYSTAL BUS	VARIOUS
R		LGE COACHWORKS	VARIOUS
R	11-20	NEXUS CLASS C	MOTORHOMES
R	11-24	PHANTOM	All MotorHomes with Ford E350 or E450 Chassis
R	20-24	TRIUMPH	All MotorHomes with Ford E350 or E450 Chassis
R	24	VIPER	29V MotorHomes with Ford E350 or E450 Chassis
R	11-23	VIPER	All MotorHomes with Ford E350 or E450 Chassis
R	00-23	PHOENIX CRUISER	All MotorHomes with Ford E350 or E450 Chassis
R		SHASTA RV	ALL MODELS
R		STARCRAFT BUS CO.	E350 & E450 FORD CHASSIS MODELS
R	92-20	THOMAS TYPE A	SCHOOL BUS
R	26	THOR MOTOR COACH	AXIS All With Ford E-450 Super Duty
R	14-24	AXIS	All MotorHomes with Ford E350 or E450 Chassis
R	11-24	CHATEAU	All MotorHomes with Ford E350 or E450 Chassis
R	11-12	CHATEAU CITATION	All MotorHomes with Ford E350 or E450 Chassis
R	12-16	CITATION	All MotorHomes with Ford E350 or E450 Chassis
R	22-24	ECHELON	All MotorHomes with Ford E350 or E450 Chassis
R	11-24	FOUR WINDS	All MotorHomes with Ford E350 or E450 Chassis
R	25	FOUR WINDS	282
R	12-24	FREEDOM ELITE	All MotorHomes with Ford E350 or E450 Chassis
R	11-23	OUTLAW	All MotorHomes with Ford E350 or E450 Chassis
R	26	PASADENA	All SE19 Submodel; with Ford E-450 Super Duty
R	16-24	QUANTUM	All MotorHomes with Ford E350 or E450 Chassis
R	25	VEGAS	24.1 MotorHomes with Ford E350 or E450 Chassis
R	14-24	VEGAS	All MotorHomes with Ford E350 or E450 Chassis
R		TURTLETOP BUS	VARIOUS
R		WHEELED COACH IND.	VARIOUS
R	07-13	WINNEBAGO ACCESS	All MotorHomes with Ford E350 or E450 Chassis
R	14	ACCESS PREMIER	All MotorHomes with Ford E350 or E450 Chassis
R	18-20	ASPECT	
R	06-17	ASPECT	All MotorHomes with Ford E350 or E450 Chassis
R	18-20	CAMBRIA	
R	09-15	CAMBRIA	
R	16-17	CAMBRIA	All MotorHomes with Ford E350 or E450 Chassis
R	05-08	CAMBRIA	All MotorHomes with Ford E350 or E450 Chassis
R	06-20	MINNIE	
R	99	MINNIE	
R	00-05	MINNIE	All MotorHomes with Ford E350 or E450 Chassis

Numerical listing

Shock	POP	Alternative No.	MTG Acc. Supplied
Pos.	Year	Application	
58623	D (cont)		142617
R	14-24	MINNIE WINNIE All MotorHomes with Ford E350 or E450 Chassis	
R	00-06	MINNIE WINNIE All MotorHomes with Ford E350 or E450 Chassis	
R	11-18	OUTLOOK	
R	19-21	OUTLOOK All MotorHomes with Ford E350 or E450 Chassis	
R	06-10	OUTLOOK All MotorHomes with Ford E350 or E450 Chassis	
R	08-15	SPIRIT	
R	16-22	SPIRIT All MotorHomes with Ford E350 or E450 Chassis	
R	00-07	SPIRIT All MotorHomes with Ford E350 or E450 Chassis	
R		WORLD TRANS BUS CO. VARIOUS	
58638	A		
R	09-22	CHEVROLET EXPRESS 4500 All	
58809	B		
F	99-04	FORD PICKUP, F-450 SUPERDUTY All	
F	99-04	PICKUP, F-550 SUPERDUTY All	
58944	W		143146
F	07-12	FORD PICKUP, F-450 SUPERDUTY All	
F	10-12	PICKUP, F-550 SUPERDUTY All	
ProGuard			
61500	A		
R	68-72	INTERNATIONAL M1100 / M1200 All	
R	69	M1400 All	
61554	C		
R	88-97	FORD F-SUPER DUTY All	
R	97	PICKUP, F-450 SUPERDUTY All	
61646	W		142617
R	26	ENTEGRA COACH ODYSSEY 24B Motorhomes with Ford E450 Chassis	
R	26	ODYSSEY 30Z Motorhomes with Ford E450 Chassis	
R	00-02	FORD E-450 ECONOLINE SUPER DUTY All	
R	21-26	VAN 1 TON, ECONOLINE / CLUB WAGON / SUPERDUTY All	
R	03-19	VAN 1 TON, ECONOLINE / CLUB WAGON / SUPERDUTY All	
R	25-26	JAYCO GREYHAWK 29MV Motorhomes with Ford E450 Chassis	
R	25	REDHAWK 30Z	
R	25-26	REDHAWK 31FF All Motorhomes with Ford E350 Chassis	
R	24	NEXUS VIPER 29V	
R	26	THOR MOTOR COACH AXIS All Motorhomes with Ford E450 Chassis	
R	25	FOUR WINDS 282	
R	26	PASADENA All SE19 Model; Motorhomes with Ford E350 Chassis	
R	25	VEGAS 24.1	
61655	B		
R	02	FORD E-550 ECONOLINE SUPER DUTY All	
R	03	E-550 SUPER DUTY All	
F	99-04	PICKUP, F-450 SUPERDUTY All	
F	99-04	PICKUP, F-550 SUPERDUTY All	
61685	A		143276
F	09-22	CHEVROLET EXPRESS 4500 All	
F	10-20	GMC SAVANA 4500 All	
61687	A		
R	09-22	CHEVROLET EXPRESS 4500 All	
R	10-20	GMC SAVANA 4500 All	
Max Control			
77461	B		
R	99-04	FORD PICKUP, F-450 SUPERDUTY All	
R	99-04	PICKUP, F-550 SUPERDUTY All	
77614	A		140780
F	17-24	BERKSHIRE COACH ULTRA 24	
F	17-24	ULTRA 28	
F	92-24	BLUE BIRD MICROBIRD TYPE A SCHOOL BUS	
F		CHAMPION BUS INC. AMERICAN COACH	
F		CHALLENGER	

LTV Severe Duty, ProGuard, Max Control

Shock	POP	Alternative No.	MTG Acc. Supplied
Pos.	Year	Application	
77614	A (cont)		140780
F		CRUSADER	
F		LF TRANSPORT	
F	03-24	COACH HOUSE PLATINUM All Motorhomes with Ford E450 Chassis	
F	23-24	PLATINUM IV All Motorhomes with Ford E450 Chassis	
F		COACHMEN CATALINA	
F	20-22	CONCORD	
F	04-06	CONCORD	
F	23-24	CONCORD All MotorHomes with Ford E350 or E450 Chassis	
F	07-19	CONCORD All MotorHomes with Ford E350 or E450 Chassis	
F	04-08	FREEDOM EXPRESS	
F	09	FREEDOM EXPRESS All MotorHomes with Ford E350 or E450 Chassis	
F	03-07	FREELANDER	
F	08-24	FREELANDER All MotorHomes with Ford E350 or E450 Chassis	
F	10	LEPRECHAUN	
F	03-07	LEPRECHAUN	
F	11-24	LEPRECHAUN All MotorHomes with Ford E350 or E450 Chassis	
F	08-09	LEPRECHAUN All MotorHomes with Ford E350 or E450 Chassis	
F	98-03	PATHFINDER	
F	99-06	SANTARA	
F		COLLINS BUS CORP. VARIOUS DIAMOND COACH SHUTTLE BUSES	
F	92-09	DUTCHMEN RV CLASS C MOTORHOMES	
F	15-20	JAMBOREE	
F	92-17	DYNAMAX CORP ISATA 4	
F	18-20	ISATA 4 All MotorHomes with Ford E350 or E450 Chassis	
F		ELDORADO NATIONAL ADVANTAGE	
F		AEROLITE	
F		AEROTECH	
F	17	ENTEGRA COACH ESTEEM	
F	18-24	ESTEEM All MotorHomes with Ford E350 or E450 Chassis	
F	17	ODYSSEY	
F	25-26	ODYSSEY 24B Motorhomes with Ford E450 Chassis	
F	25-26	ODYSSEY 30Z Motorhomes with Ford E450 Chassis	
F	18-24	ODYSSEY All MotorHomes with Ford E350 or E450 Chassis	
F	23-24	ODYSSEY SE All MotorHomes with Ford E450 Chassis	
F		FEDERAL COACH VARIOUS	
F	20	FLEETWOOD JAMBOREE	
F	14-16	JAMBOREE	
F	99-07	JAMBOREE	
F	17-19	JAMBOREE All MotorHomes with Ford E350 or E450 Chassis	
F	08-13	JAMBOREE All MotorHomes with Ford E350 or E450 Chassis	
F	19-20	SURGE	
F	18	SURGE All MotorHomes with Ford E350 or E450 Chassis	
F	14-16	TIOGA	
F	99-07	TIOGA	
F	08-13	TIOGA All MotorHomes with Ford E350 or E450 Chassis	
F	00-02	FORD E-450 ECONOLINE SUPER DUTY All	
F	21-26	VAN 1 TON, ECONOLINE / CLUB WAGON / SUPERDUTY All	
F	03-19	VAN 1 TON, ECONOLINE / CLUB WAGON / SUPERDUTY All	
F		FOREST RIVER ALL AMERICAN	
F	20	FORESTER	
F	04-19	FORESTER All MotorHomes with Ford E350 or E450 Chassis	
F	15-18	FORESTER GTS All MotorHomes with Ford E350 or E450 Chassis	
F	03-15	LEXINGTON All MotorHomes with Ford E350 or E450 Chassis	
F	21-24	SOLERA All MotorHomes with Ford E350 or E450 Chassis	
F	10-15	SOLERA All MotorHomes with Ford E350 or E450 Chassis	
F	23	SUNSEEKER	
F	99-06	SUNSEEKER	
F	07-22	SUNSEEKER All MotorHomes with Ford E350 or E450 Chassis	
F	19-20	SUNSEEKER GTS	
F	15-18	SUNSEEKER GTS All MotorHomes with Ford E350 or E450 Chassis	

Numerical listing

Shock	POP	Alternative No.	MTG Acc. Supplied
Pos.	Year	Application	
77614	A (cont)		140780
F	99-09	GEORGIE BOY MANUFACTURING CLASS C MOTORHOMES	
F		GLAVAL BUS CO. VARIOUS	
F		GOSHEN COACH VARIOUS	
F		GRECH MOTORS VARIOUS	
F	02-15	GULF STREAM BT CRUISER	
F	16-24	BT CRUISER All MotorHomes with Ford E350 or E450 Chassis	
F	99-06	CAVALIER	
F	12-15	CONQUEST	
F	93-01	CONQUEST	
F	16-24	CONQUEST All MotorHomes with Ford E350 or E450 Chassis	
F	02-11	CONQUEST All MotorHomes with Ford E350 or E450 Chassis	
F	10-11	CONQUEST SPORT All MotorHomes with Ford E350 or E450 Chassis	
F	01-02	CONQUEST SPORT All MotorHomes with Ford E350 or E450 Chassis	
F	00-11	INDEPENDENCE All MotorHomes with Ford E350 or E450 Chassis	
F	10-11	MONTAJ All MotorHomes with Ford E350 or E450 Chassis	
F	00-08	ULTRA	
F	02-04	YELLOWSTONE	
F	05-11	YELLOWSTONE All MotorHomes with Ford E350 or E450 Chassis	
F	19	HOLIDAY RAMBLER ALTERA	
F	18	ALTERA All MotorHomes with Ford E450 Chassis	
F	08	ATLANTIS	
F	06	ATLANTIS	
F	99-01	ATLANTIS	
F	09-10	ATLANTIS All MotorHomes with Ford E450 Chassis	
F	07	ATLANTIS All MotorHomes with Ford E450 Chassis	
F	02-05	ATLANTIS All MotorHomes with Ford E450 Chassis	
F	19	AUGUSTA All MotorHomes with Ford E450 Chassis	
F	15-16	AUGUSTA All MotorHomes with Ford E450 Chassis	
F	11	AUGUSTA All MotorHomes with Ford E450 Chassis	
F	08-09	AUGUSTA All MotorHomes with Ford E450 Chassis	
F	12-13	AUGUSTA B+ All MotorHomes with Ford E450 Chassis	
F	10	AUGUSTA B+ All MotorHomes with Ford E450 Chassis	
F	07	AUGUSTA B+ All MotorHomes with Ford E450 Chassis	
F	16	AUGUSTA LX All MotorHomes with Ford E450 Chassis	
F	07-10	AUGUSTA SPORT All MotorHomes with Ford E350 Chassis	
F	07-09	AUGUSTA TOURING SEDAN All MotorHomes with Ford E350 Chassis	
F	17-18	VESTA All MotorHomes with Ford E450 Chassis	
F	01-20	ITASCA CLASS C MOTORHOMES	
F	03-06	JAYCO ESCAPADE All MotorHomes with Ford E350 or E450 Chassis	
F	02-06	GRANITE RIDGE All MotorHomes with Ford E350 or E450 Chassis	
F	26	GREYHAWK 29MV Motorhomes with Ford E450 Chassis	
F	02-24	GREYHAWK All MotorHomes with Ford E450 Chassis	
F	07-24	MELBOURNE All MotorHomes with Ford E350 or E450 Chassis	
F	13-24	REDHAWK All MotorHomes with Ford E450 Chassis	
F	25	REDHAWK 30Z	
F	25-26	REDHAWK 31FF	
F	18-26	REDHAWK SE All MotorHomes with Ford E450 Chassis	
F	26	REDHAWK SE All MotorHomes with Ford E350 Chassis	
F		KRYSTAL BUS VARIOUS	
F		LGE COACHWORKS VARIOUS	
F	11-12	NEXUS CLASS C MOTORHOMES	
F	11-24	PHANTOM All MotorHomes with Ford E350 or E450 Chassis	
F	20-24	TRIUMPH All MotorHomes with Ford E350 or E450 Chassis	
F	24	VIPER 29V MotorHomes with Ford E350 or E450 Chassis	

Numerical listing

Shock	POP	Alternative No.	MTG Acc. Supplied
Pos.	Year	Application	
77614		A (cont)	140780
F	11-23	VIPER All MotorHomes with Ford E350 or E450 Chassis	
F	00-23	PHOENIX CRUISER All MotorHomes with Ford E350 or E450 Chassis	
F		SHASTA RV ALL MODELS	
F		STARCRAFT BUS CO. E350 & E450 FORD CHASSIS MODELS	
F	92-22	THOMAS TYPE A SCHOOL BUS	
F	25-26	THOR MOTOR COACH AXIS 26.2 Motorhomes with Ford E450 Chassis	
F	14-24	AXIS All MotorHomes with Ford E350 or E450 Chassis	
F	11-24	CHATEAU All MotorHomes with Ford E350 or E450 Chassis	
F	11-12	CHATEAU CITATION All MotorHomes with Ford E350 or E450 Chassis	
F	12-16	CITATION All MotorHomes with Ford E350 or E450 Chassis	
F	22-24	ECHELON All MotorHomes with Ford E350 or E450 Chassis	
F	11-24	FOUR WINDS All MotorHomes with Ford E350 or E450 Chassis	
F	24	FOUR WINDS 28A MotorHomes with Ford E350 or E450 Chassis	
F	25	FOUR WINDS 282	
F	12-24	FREEDOM ELITE All MotorHomes with Ford E350 or E450 Chassis	
F	11-23	OUTLAW All MotorHomes with Ford E350 or E450 Chassis	
F	26	PASADENA All Motorhomes with Ford E350 Chassis	
F	16-24	QUANTUM All MotorHomes with Ford E350 or E450 Chassis	
F	25	VEGAS 24.1	
F	14-24	VEGAS All MotorHomes with Ford E350 or E450 Chassis	
F		TURTLETOP BUS VARIOUS	
F		WHEELED COACH IND. VARIOUS	
F	07-13	WINNEBAGO ACCESS All MotorHomes with Ford E350 or E450 Chassis	
F	14	ACCESS PREMIER All MotorHomes with Ford E350 or E450 Chassis	
F	18-20	ASPECT	
F	05-17	ASPECT All MotorHomes with Ford E350 or E450 Chassis	
F	18-20	CAMBRIA	
F	09-15	CAMBRIA	
F	16-17	CAMBRIA All MotorHomes with Ford E350 or E450 Chassis	
F	05-08	CAMBRIA All MotorHomes with Ford E350 or E450 Chassis	
F	06-20	MINNIE	
F	99	MINNIE	
F	00-05	MINNIE All MotorHomes with Ford E350 or E450 Chassis	
F	14-24	MINNIE WINNIE All MotorHomes with Ford E350 or E450 Chassis	
F	00-06	MINNIE WINNIE All MotorHomes with Ford E350 or E450 Chassis	
F	11-18	OUTLOOK	
F	19-21	OUTLOOK All MotorHomes with Ford E350 or E450 Chassis	
F	06-10	OUTLOOK All MotorHomes with Ford E350 or E450 Chassis	
F	08-15	SPIRIT	
F	16-22	SPIRIT All MotorHomes with Ford E350 or E450 Chassis	
F	00-07	SPIRIT All MotorHomes with Ford E350 or E450 Chassis	
F		WORLD TRANS BUS CO. VARIOUS	
77623		D	142731
R	17-24	BERKSHIRE COACH ULTRA 24	
R	17-24	ULTRA 28	
R	92-24	BLUE BIRD MICROBIRD TYPE A SCHOOL BUS	
R		CHAMPION BUS INC. AMERICAN COACH	
R		CHALLENGER	
R		CRUSADER	
R		LF TRANSPORT	
R	03-24	COACH HOUSE PLATINUM All Motorhomes with Ford E450 Chassis	
R	23-24	PLATINUM IV All Motorhomes with Ford E450 Chassis	
R		COACHMEN CATALINA	
R	20-22	CONCORD	
R	04-06	CONCORD	

Max Control

Shock	POP	Alternative No.	MTG Acc. Supplied
Pos.	Year	Application	
77623		D (cont)	142731
R	23-24	CONCORD All MotorHomes with Ford E350 or E450 Chassis	
R	07-19	CONCORD All MotorHomes with Ford E350 or E450 Chassis	
R	04-08	FREEDOM EXPRESS	
R	09	FREEDOM EXPRESS All MotorHomes with Ford E350 or E450 Chassis	
R	03-07	FREELANDER	
R	08-24	FREELANDER All MotorHomes with Ford E350 or E450 Chassis	
R	10	LEPRECHAUN	
R	03-07	LEPRECHAUN	
R	11-24	LEPRECHAUN All MotorHomes with Ford E350 or E450 Chassis	
R	08-09	LEPRECHAUN All MotorHomes with Ford E350 or E450 Chassis	
R	98-03	PATHFINDER	
R	99-06	SANTARA	
R		COLLINS BUS CORP. VARIOUS	
R		DIAMOND COACH SHUTTLE BUSES	
R	92-09	DUTCHMEN RV CLASS C MOTORHOMES	
R	15-20	JAMBOREE	
R	92-17	DYNAMAX CORP ISATA 4	
R	18-20	ISATA 4 All MotorHomes with Ford E350 or E450 Chassis	
R		ELDORADO NATIONAL ADVANTAGE	
R		AEROLITE	
R		AEROTECH	
R	17	INTEGRA COACH ESTEEM	
R	18-24	ESTEEM All MotorHomes with Ford E350 or E450 Chassis	
R	17	ODYSSEY	
R	25-26	ODYSSEY 30Z Motorhomes with Ford E450 Chassis	
R	25-26	ODYSSEY All Motorhomes with Ford E450 Chassis	
R	18-24	ODYSSEY All MotorHomes with Ford E350 or E450 Chassis	
R	23-24	ODYSSEY SE All MotorHomes with Ford E450 Chassis	
R		FEDERAL COACH VARIOUS	
R	20	FLEETWOOD JAMBOREE	
R	14-16	JAMBOREE	
R	99-07	JAMBOREE	
R	17-19	JAMBOREE All MotorHomes with Ford E350 or E450 Chassis	
R	08-13	JAMBOREE All MotorHomes with Ford E350 or E450 Chassis	
R	19-20	SURGE	
R	18	SURGE All MotorHomes with Ford E350 or E450 Chassis	
R	14-16	TIOGA	
R	99-07	TIOGA	
R	08-13	TIOGA All MotorHomes with Ford E350 or E450 Chassis	
R	00-02	FORD E-450 ECONOLINE SUPER DUTY All Exc. Cutaway Chassis	
R	21-26	VAN 1 TON, ECONOLINE / CLUB WAGON / SUPERDUTY All	
R	03-19	VAN 1 TON, ECONOLINE / CLUB WAGON / SUPERDUTY All Exc. Cutaway Chassis	
R		FOREST RIVER ALL AMERICAN	
R	20	FORESTER	
R	04-19	FORESTER All MotorHomes with Ford E350 or E450 Chassis	
R	15-18	FORESTER GTS All MotorHomes with Ford E350 or E450 Chassis	
R	03-15	LEXINGTON All MotorHomes with Ford E350 or E450 Chassis	
R	21-24	SOLERA All MotorHomes with Ford E350 or E450 Chassis	
R	10-15	SOLERA All MotorHomes with Ford E350 or E450 Chassis	
R	23	SUNSEEKER	
R	99-06	SUNSEEKER	
R	07-22	SUNSEEKER All MotorHomes with Ford E350 or E450 Chassis	
R	19-20	SUNSEEKER GTS	
R	15-18	SUNSEEKER GTS All MotorHomes with Ford E350 or E450 Chassis	
R	99-09	GEORGIE BOY MANUFACTURING CLASS C MOTORHOMES	
R		GLAVAL BUS CO. VARIOUS	
R		GOSHEN COACH VARIOUS	
R		GRECH MOTORS VARIOUS	
R	02-15	GULF STREAM BT CRUISER	
R	16-24	BT CRUISER All MotorHomes with Ford E350 or E450 Chassis	
R	99-06	CAVALIER	

Numerical listing

Shock	POP	Alternative No.	MTG Acc. Supplied
Pos.	Year	Application	
77623		D (cont)	142731
R	12-15	CONQUEST	
R	93-01	CONQUEST	
R	16-24	CONQUEST All MotorHomes with Ford E350 or E450 Chassis	
R	02-11	CONQUEST All MotorHomes with Ford E350 or E450 Chassis	
R	10-11	CONQUEST SPORT All MotorHomes with Ford E350 or E450 Chassis	
R	01-02	CONQUEST SPORT All MotorHomes with Ford E350 or E450 Chassis	
R	00-11	INDEPENDENCE All MotorHomes with Ford E350 or E450 Chassis	
R	10-11	MONTAJ All MotorHomes with Ford E350 or E450 Chassis	
R	00-08	ULTRA	
R	02-04	YELLOWSTONE	
R	05-11	YELLOWSTONE All MotorHomes with Ford E350 or E450 Chassis	
R	19	HOLIDAY RAMBLER ALTERA	
R	18	ALTERA All MotorHomes with Ford E450 Chassis	
R	08	ATLANTIS	
R	06	ATLANTIS	
R	99-01	ATLANTIS	
R	09-10	ATLANTIS All MotorHomes with Ford E450 Chassis	
R	07	ATLANTIS All MotorHomes with Ford E450 Chassis	
R	02-05	ATLANTIS All MotorHomes with Ford E450 Chassis	
R	19	AUGUSTA All MotorHomes with Ford E450 Chassis	
R	15-16	AUGUSTA All MotorHomes with Ford E450 Chassis	
R	11	AUGUSTA All MotorHomes with Ford E450 Chassis	
R	08-09	AUGUSTA All MotorHomes with Ford E450 Chassis	
R	12-13	AUGUSTA B+ All MotorHomes with Ford E450 Chassis	
R	10	AUGUSTA B+ All MotorHomes with Ford E450 Chassis	
R	07	AUGUSTA B+ All MotorHomes with Ford E450 Chassis	
R	16	AUGUSTA LX All MotorHomes with Ford E450 Chassis	
R	07-10	AUGUSTA SPORT All MotorHomes with Ford E350 Chassis	
R	07-09	AUGUSTA TOURING SEDAN All MotorHomes with Ford E350 Chassis	
R	17-18	VESTA All MotorHomes with Ford E450 Chassis	
R	01-20	ITASCA CLASS C MOTORHOMES	
R	03-06	JAYCO ESCAPE All MotorHomes with Ford E350 or E450 Chassis	
R	02-06	GRANITE RIDGE All MotorHomes with Ford E350 or E450 Chassis	
R	25-26	GREYHAWK 29MV Motorhomes with Ford E450 Chassis	
R	02-24	GREYHAWK All MotorHomes with Ford E450 Chassis	
R	07-24	MELBOURNE All MotorHomes with Ford E350 or E450 Chassis	
R	13-24	REDHAWK All MotorHomes with Ford E450 Chassis	
R	25	REDHAWK 30Z	
R	26	REDHAWK 31FF	
R	25-26	REDHAWK SE All Motorhomes with Ford E350 Chassis	
R	18-24	REDHAWK SE All MotorHomes with Ford E450 Chassis	
R		KRYSTAL BUS VARIOUS	
R		LGE COACHWORKS VARIOUS	
R	11-20	NEXUS CLASS C MOTORHOMES	
R	11-24	PHANTOM All MotorHomes with Ford E350 or E450 Chassis	
R	20-24	TRIUMPH All MotorHomes with Ford E350 or E450 Chassis	
R	24	VIPER 29V MotorHomes with Ford E350 or E450 Chassis	
R	11-23	VIPER All MotorHomes with Ford E350 or E450 Chassis	
R	00-23	PHOENIX CRUISER All MotorHomes with Ford E350 or E450 Chassis	
R		SHASTA RV ALL MODELS	
R		STARCRAFT BUS CO. E350 & E450 FORD CHASSIS MODELS	
R	92-20	THOMAS TYPE A SCHOOL BUS	

Numerical listing

Shock	POP	Alternative No.	MTG Acc. Supplied
Pos.	Year	Application	
77623	D	(cont)	142731
R	25-26	THOR MOTOR COACH AXIS All Motorhomes with Ford E450 Chassis	
R	14-24	AXIS All MotorHomes with Ford E350 or E450 Chassis	
R	11-24	CHATEAU All MotorHomes with Ford E350 or E450 Chassis	
R	11-12	CHATEAU CITATION All MotorHomes with Ford E350 or E450 Chassis	
R	12-16	CITATION All MotorHomes with Ford E350 or E450 Chassis	
R	22-24	ECHELON All MotorHomes with Ford E350 or E450 Chassis	
R	11-24	FOUR WINDS All MotorHomes with Ford E350 or E450 Chassis	
R	25	FOUR WINDS 282	
R	12-24	FREEDOM ELITE All MotorHomes with Ford E350 or E450 Chassis	
R	11-23	OUTLAW All MotorHomes with Ford E350 or E450 Chassis	
R	25	PASADENA All SE19 Model; Motorhomes with Ford E350 Chassis	
R	16-24	QUANTUM All MotorHomes with Ford E350 or E450 Chassis	
R	25	VEGAS 24.1	
R	14-24	VEGAS All MotorHomes with Ford E350 or E450 Chassis	
R		TURTLETOP BUS VARIOUS	
R		WHEELED COACH IND. VARIOUS	
R	07-13	WINNEBAGO ACCESS All MotorHomes with Ford E350 or E450 Chassis	
R	14	ACCESS PREMIER All MotorHomes with Ford E350 or E450 Chassis	
R	18-20	ASPECT	
R	06-17	ASPECT All MotorHomes with Ford E350 or E450 Chassis	
R	18-20	CAMBRIA	
R	09-15	CAMBRIA	
R	16-17	CAMBRIA All MotorHomes with Ford E350 or E450 Chassis	
R	05-08	CAMBRIA All MotorHomes with Ford E350 or E450 Chassis	
R	06-20	MINNIE	
R	99	MINNIE	
R	00-05	MINNIE All MotorHomes with Ford E350 or E450 Chassis	
R	14-24	MINNIE WINNIE All MotorHomes with Ford E350 or E450 Chassis	
R	00-06	MINNIE WINNIE All MotorHomes with Ford E350 or E450 Chassis	
R	11-18	OUTLOOK	
R	19-21	OUTLOOK All MotorHomes with Ford E350 or E450 Chassis	
R	06-10	OUTLOOK All MotorHomes with Ford E350 or E450 Chassis	
R	08-15	SPIRIT	
R	16-22	SPIRIT All MotorHomes with Ford E350 or E450 Chassis	
R	00-07	SPIRIT All MotorHomes with Ford E350 or E450 Chassis	
R		WORLD TRANS BUS CO. VARIOUS	
77638	A		
R	09-22	CHEVROLET EXPRESS 4500 All	
R	10-20	GMC SAVANA 4500 All	
77809	A		
F	99-04	FORD PICKUP , F-450 SUPERDUTY All	
F	99-04	PICKUP , F-550 SUPERDUTY All	
77907	W		
R	96-04	MITSUBISHI FUSO FE All Model with O.E.M Number	
R	98-04	FG All Model with O.E.M Number	
77967	D		143146
F	20-24	FORD F-600 SUPER DUTY All Applications with OEM Number	
F	13-24	PICKUP , F-450 SUPERDUTY All	
F	05-08	PICKUP , F-450 SUPERDUTY All	
F	13-24	PICKUP , F-550 SUPERDUTY All	
F	05-07	PICKUP , F-550 SUPERDUTY All	
77968	W		
R	13-16	FORD PICKUP , F-450 SUPERDUTY 4 X 2	
R	05-07	PICKUP , F-450 SUPERDUTY 4 X 2	
R	13-16	PICKUP , F-550 SUPERDUTY 4 X 2	
R	05-07	PICKUP , F-550 SUPERDUTY 4 X 2	

Shock	POP	Alternative No.	MTG Acc. Supplied
Pos.	Year	Application	
77969	W		
R	13-16	FORD PICKUP , F-450 SUPERDUTY 4 X 4	
R	05-07	PICKUP , F-450 SUPERDUTY 4 X 4	
R	13-16	PICKUP , F-550 SUPERDUTY 4 X 4	
R	05-07	PICKUP , F-550 SUPERDUTY 4 X 4	
77986	W		
R	24	FORD PICKUP , F-450 SUPERDUTY 4 X 4 Models with 4WD and OEM number	
R	17-23	PICKUP , F-450 SUPERDUTY All Models with 4WD and OEM number	
R	24	PICKUP , F-550 SUPERDUTY 4 X 4 Models with 4WD and OEM number	
R	17-23	PICKUP , F-550 SUPERDUTY All Models with 4WD and OEM number	
R	17-23	PIERCE MFG. INC. VARIOUS	
R	19-23	RENEGADE VERACRUZ All Models with Ford F-550 Chassis (4WD and OEM number)	
R	19-23	THOR MOTOR COACH MAGNITUDE All Models with Ford F-550 Chassis (4WD and OEM number)	
R	19-23	OMNI All Models with Ford F-550 Chassis (4WD and OEM number)	
77987	W		
R	20-24	FORD F-600 SUPER DUTY 4 X 2 Models with RWD and OEM number	
R	24	PICKUP , F-450 SUPERDUTY RWD Models with RWD and OEM number	
R	17-23	PICKUP , F-450 SUPERDUTY All Models with RWD and OEM number	
R	24	PICKUP , F-550 SUPERDUTY RWD Models with RWD and OEM number	
R	17-23	PICKUP , F-550 SUPERDUTY All Models with RWD and OEM number	
R	19-23	THOR MOTOR COACH MAGNITUDE All Models with Ford F-550 Chassis (RWD and OEM number)	
R	19-23	OMNI All Models with Ford F-550 Chassis (RWD and OEM number)	
Guardian Shock			
81147	B		
R	68-72	INTERNATIONAL M1100 / M1200 All	
R	69	M1400 All	
81710	C		
R	88-97	FORD F-SUPER DUTY All	
81744	A		140780
F	21-24	FORD VAN 1 TON, ECONOLINE / CLUB WAGON / SUPERDUTY All	
F	10-19	VAN 1 TON, ECONOLINE / CLUB WAGON / SUPERDUTY All	
81828	W		142617
R	21-24	FORD VAN 1 TON, ECONOLINE / CLUB WAGON / SUPERDUTY All	
R	10-19	VAN 1 TON, ECONOLINE / CLUB WAGON / SUPERDUTY All	
Classic Shock Absorbers			
82007	B		140349
F	68-72	INTERNATIONAL M1100 / M1200 All	
F	69	M1400 All	
Cab Shock			
83006	W		
	95-05	FREIGHTLINER FL50 All Day Cab Suspensions with O.E.M. Number	
	96-05	FL60 All Day Cab Suspensions with O.E.M. Number	
83021	C		
	90-96	CHEVROLET C60 KODIAK All Truck Cabs with Link Cabmate Model GMC104TK	
	03-09	C4500 KODIAK All Truck Cabs with Link Cabmate Model GMC104TK	
	03-09	C5500 KODIAK All Truck Cabs with Link Cabmate Model GMC104TK	
	90-91	C5500 KODIAK All Truck Cabs with Link Cabmate Model GMC104TK	
	97-09	C6500 KODIAK All Truck Cabs with Link Cabmate Model GMC104TK	
	00-01	C7500 KODIAK All Truck Cabs with Link Cabmate Model GMC104TK	

Numerical listing

Shock	POP	Alternative No.	MTG Acc. Supplied
Pos.	Year	Application	
83021	C	(cont)	
	91-05	FREIGHTLINER FL60 All Trucks with Link Cabmate Models FRT153BC-A , FRT106BC or FRT106HD-A	
	03-09	GMC C4500 TOPKICK All Truck Cabs with Link Cabmate Model GMC104TK	
	03-09	C5500 TOPKICK All Truck Cabs with Link Cabmate Model GMC104TK	
	90-96	C6000 TOPKICK All Truck Cabs with Link Cabmate Model GMC104TK	
	03-09	C6500 TOPKICK All Truck Cabs with Link Cabmate Model GMC104TK	
	97-01	C6500 TOPKICK All Truck Cabs with Link Cabmate Model GMC104TK	
	05-08	ISUZU HVR All Truck Cabs with Link Cabmate Model GMC104TK	
	96-97	MARMON HERRINGTON 57 GLIDER All Conventional Tractors with Link Cabmate Model MARC57-B	
	90-94	57 GLIDER All Conventional Tractors with Link Cabmate Model MARC57-B	
83025	C		
	03-09	GMC C4500 TOPKICK All Models with Link Cabmate Model GMT560	
	03-09	C5500 TOPKICK All Models with Link Cabmate Model GMT560	
83038	A		
	03-22	PIERCE MFG. INC. VARIOUS	
83039	W		
	03-24	PIERCE MFG. INC. VARIOUS	
83040	W		
	02-24	FREIGHTLINER M2 106 All Day Cab Models with Spring Suspensions	
	02-24	PIERCE MFG. INC. VARIOUS	
83054	W		
	02-20	INTERNATIONAL 4300 All Models with O.E.M. Number	
	02-19	4300LP All Models with O.E.M. Number	
	02-20	4400 All Models with O.E.M. Number	
	02-19	4400LP All Models with O.E.M. Number	
	15-20	DURASTAR All Models with O.E.M. Number	
	13	DURASTAR All Models with O.E.M. Number	
	19-23	PIERCE MFG. INC. VARIOUS	
83066	W		
	23	MACK MD6	
	24	MD6 All Models with O.E.M. Number	
	21-22	MD6 All Models with O.E.M. Number	
83000 Series			
83101	D		
R	02-13	FORD F-650 All Models with Vari-Rate Rear Suspension	
F	13	INTERNATIONAL 4300LP All Models with O.E.M. Number	
R		SERIES 1000 FORWARD CONTROL CHASSIS	
83102	W		145089-000 (2)
F		THOMAS VARIOUS	
83103	W		145054 (2)
R	93-99	MITSUBISHI CANTER FE516BC	
R	88-95	CANTER FH100	
R	88-96	MITSUBISHI FUSO FH All Models with O.E.M. Number	
83112	C		145128 (1)
R		INTERNATIONAL SERIES 4000 - SHORT CONVENTIONAL MEDIUM TRK & TRAC	
83114	W		140780 (1)
F	00-04	ISUZU FRR All	
F	95-98	FRR All	

Numerical listing

Shock	POP	Alternative No.	MTG Acc. Supplied
Pos.	Year	Application	
83114	W	(cont)	140780 (1)
F	86	FSR	
F	88-94	NRR All	
F	00-01	MITSUBISHI CANTER 35	
F	00-05	CANTER 55	
F	01-05	CANTER 60	
F	01-05	CANTER 75	
F	01-10	CANTER FB SERIES	
F	86-95	CANTER FE SERIES	
F	90-95	CANTER FH100	
F	87-08	CANTER FK SERIES	
F	76-84	CANTER FK SERIES	
F	76-84	CANTER FM SERIES	
F	03-08	CANTER FN SERIES	
F	01-10	MITSUBISHI FUSO FE SERIES	
F	89-94	UD 1800 All Models with O.E.M. Number	
F	99-04	1800CS All Models with O.E.M. Number	
F	89-94	2000 All Models with O.E.M. Number	
83119	W		
F		FREIGHTLINER VARIOUS	
83120	W		145089-000(1)/145143(1)
R	05-22	FREIGHTLINER B2 All Models with 15,000 lb Rear Suspension	
R	97-08	BUS CHASSIS	
R	95-05	FL50 All Models with 15,000 lb Rear Suspension	
R	91-05	FL60 All w/ 15000 lb Rear Suspension	
R	98-20	MT45 All Models with O.E.M. Number	
R	99-11	MT55 All Models with O.E.M. Number	
R		VARIOUS	
R	03-10	STERLING TRUCK ACTERRA All Models with 15000 lb Rear Suspension	
R	01-07	ACTERRA 5500 All Models with 15000 lb Rear Suspension	
R	01-07	ACTERRA 6500 All Models with 15000 lb Rear Suspension	
R	05-22	THOMAS VARIOUS	
R		UPS TRUCK VARIOUS	
83122	W		
R	97-09	CHEVROLET C6500 KODIAK All Models with Hendrickson Air Suspension (Stamping number 47902-13)	
R	00-01	C7500 KODIAK All Models with Hendrickson Air Suspension (Stamping number 47902-13)	
R	99	T6500 All Models with Hendrickson Air Suspension (Stamping number 47902-13)	
R	99	T7500 All Models with Hendrickson Air Suspension (Stamping number 47902-13)	
R	04-09	T8500 All Models with Hendrickson Air Suspension (Stamping number 47902-13)	
R	09	COACHMEN AURORA	
R	07	AURORA	
R	08	AURORA All MotorHomes with Ford F53 Chassis with 16,000 lb GVW to 22,000 lb GVW	
R	04-06	AURORA All MotorHomes with Ford F53 Chassis with 16,000 lb GVW to 22,000 lb GVW	
R	21-24	ENCORE All MotorHomes with Ford F53 Chassis with 16,000 lb GVW to 22,000 lb GVW	
R	11-16	ENCOUNTER All MotorHomes with Ford F53 Chassis with 16,000 lb GVW to 22,000 lb GVW	
R	99-07	MIRADA	
R	08-24	MIRADA All MotorHomes with Ford F53 Chassis with 16,000 lb GVW to 22,000 lb GVW	
R	04-12	PURSUIT	
R	13-24	PURSUIT All MotorHomes with Ford F53 Chassis with 16,000 lb GVW to 22,000 lb GVW	
R	12-13	DAMON DAYBREAK	
R	99	DAYBREAK	
R	99	INTRUDER	
R	12-14	OUTLAW	
R	19-20	FLEETWOOD AXON	
R	06-23	FORD F-53	
R	99-04	F-53	

83000 Series

Shock	POP	Alternative No.	MTG Acc. Supplied
Pos.	Year	Application	
83122	W	(cont)	
R	13-24	FOREST RIVER FR3 All MotorHomes with Ford F53 Chassis with 16,000 lb GVW to 22,000 lb GVW	
R	08-17	GEORGETOWN All MotorHomes with Ford F53 Chassis with 16,000 lb GVW to 22,000 lb GVW	
R	16-24	GEORGETOWN GT3 All MotorHomes with Ford F53 Chassis with 16,000 lb GVW to 22,000 lb GVW	
R	17-24	GEORGETOWN GT5 All MotorHomes with Ford F53 Chassis with 16,000 lb GVW to 22,000 lb GVW	
R	20-24	GEORGETOWN GT7 All MotorHomes with Ford F53 Chassis with 16,000 lb GVW to 22,000 lb GVW	
R	99-09	GEORGIE BOY MANUFACTURING CLASS A MOTORHOMES	
R	95-02	GMC C - SERIES (C6500, C7500, C8500) TOPKICK	
R	99	T5500	
R	99	T6500 All Models with Hendrickson Air Suspension (Stamping number 47902-13)	
R	99	T7500 All Models with Hendrickson Air Suspension (Stamping number 47902-13)	
R	11-15	HOLIDAY RAMBLER ADMIRAL	
R	02-06	ADMIRAL	
R	16-24	ADMIRAL All MotorHomes with Ford F53 Chassis with 16,000 lb GVW to 22,000 lb GVW	
R	07-10	ADMIRAL All MotorHomes with Ford F53 Chassis with 16,000 lb GVW to 22,000 lb GVW	
R	00-01	ADMIRAL All MotorHomes with Ford F53 Chassis with 16,000 lb GVW to 22,000 lb GVW	
R	02-06	ADMIRAL SE All MotorHomes with Ford F53 Chassis with 16,000 lb GVW to 22,000 lb GVW	
R	07	ADMIRAL SVE All MotorHomes with Ford F53 Chassis with 16,000 lb GVW to 22,000 lb GVW	
R	16-18	ADMIRAL XE All MotorHomes with Ford F53 Chassis with 16,000 lb GVW to 22,000 lb GVW	
R	23-24	ECLIPSE All MotorHomes with Ford F53 Chassis with 16,000 lb GVW to 22,000 lb GVW	
R	15	ENDEAVOR	
R	16-24	ENDEAVOR All MotorHomes with Ford F53 Chassis with 16,000 lb GVW to 22,000 lb GVW	
R	00-14	ENDEAVOR All MotorHomes with Ford F53 Chassis with 16,000 lb GVW to 22,000 lb GVW	
R	11-24	VACATIONER All MotorHomes with Ford F53 Chassis with 16,000 lb GVW to 22,000 lb GVW	
R	09	VACATIONER All MotorHomes with Ford F53 Chassis with 16,000 lb GVW to 22,000 lb GVW	
R	00-07	VACATIONER All MotorHomes with Ford F53 Chassis with 16,000 lb GVW to 22,000 lb GVW	
R	05-08	HVR All Models with Hendrickson Air Suspension	
R	99-15	ITASCA CLASS A MOTORHOMES	
R	16-24	JAYCO ALANTE All MotorHomes with Ford F53 Chassis with 16,000 lb GVW to 22,000 lb GVW	
R	14-24	PRECEPT All MotorHomes with Ford F53 Chassis with 16,000 lb GVW to 22,000 lb GVW	
R	99-08	NATIONAL RV CLASS A MOTORHOMES	
R	13-20	NEWMAR CLASS A MOTORHOMES	
R	17-20	NEXUS MAYBACH All MotorHomes with Ford F53 Chassis with 16,000 lb GVW to 22,000 lb GVW	
R	11-24	THOR MOTOR COACH A.C.E. All MotorHomes with Ford F53 Chassis with 16,000 lb GVW to 22,000 lb GVW	
R	05-08	CHALLENGER	
R	09-24	CHALLENGER All MotorHomes with Ford F53 Chassis with 16,000 lb GVW to 22,000 lb GVW	

Numerical listing

Shock	POP	Alternative No.	MTG Acc. Supplied
Pos.	Year	Application	
83122	W	(cont)	
R	04-10	HURRICANE	
R	11-24	HURRICANE All MotorHomes with Ford F53 Chassis with 16,000 lb GVW to 22,000 lb GVW	
R	23-24	INDIGO All MotorHomes with Ford F53 Chassis with 16,000 lb GVW to 22,000 lb GVW	
R	23-24	LUMINATE All MotorHomes with Ford F53 Chassis with 16,000 lb GVW to 22,000 lb GVW	
R	14-24	MIRAMAR All MotorHomes with Ford F53 Chassis with 16,000 lb GVW to 22,000 lb GVW	
R	07-10	OUTLAW	
R	11-23	OUTLAW All MotorHomes with Ford F53 Chassis with 16,000 lb GVW to 22,000 lb GVW	
R	23-24	RESONATE All MotorHomes with Ford F53 Chassis with 16,000 lb GVW to 22,000 lb GVW	
R	06-10	WINDSPORT	
R	11-24	WINDSPORT All MotorHomes with Ford F53 Chassis with 16,000 lb GVW to 22,000 lb GVW	
R	19-23	WINNEBAGO ADVENTURER All Motorhomes with Ford F-53 Chassis with 16,000 lb GVW to 22,000 lb GVW	
R	06-17	ADVENTURER All Motorhomes with Ford F-53 Chassis with 16,000 lb GVW to 22,000 lb GVW	
R	99-04	ADVENTURER All Motorhomes with Ford F-53 Chassis with 16,000 lb GVW to 22,000 lb GVW	
R	18-20	INTENT All Motorhome Chassis with 16,000 lb GVW to 18,000 lb GVW	
R	18-20	INTENT All Motorhome Chassis with 20,500 lb GVW to 22,000 lb GVW	
R	11-17	SIGHTSEER All Motorhome Chassis with 16,000 lb GVW to 18,000 lb GVW	
R	11-17	SIGHTSEER All Motorhome Chassis with 20,500 lb GVW to 22,000 lb GVW	
R	08-09	SIGHTSEER All Motorhome Chassis with 16,000 lb GVW to 18,000 lb GVW	
R	06-09	SIGHTSEER All Motorhome Chassis with 20,500 lb GVW to 22,000 lb GVW	
R	02-04	SIGHTSEER All Motorhome Chassis with 20,500 lb GVW to 22,000 lb GVW	
R	16-17	SUNOVA All Motorhome Chassis with 16,000 lb GVW to 18,000 lb GVW	
R	16-17	SUNOVA All Motorhome Chassis with 20,500 lb GVW to 22,000 lb GVW	
R	06-07	SUNOVA All Motorhome Chassis with 20,500 lb GVW to 22,000 lb GVW	
R	02-04	SUNOVA All Motorhome Chassis with 20,500 lb GVW to 22,000 lb GVW	
R	16-22	SUNSTAR All Motorhome Chassis with 16,000 lb GVW to 18,000 lb GVW	
R	16-22	SUNSTAR All Motorhome Chassis with 20,500 lb GVW to 22,000 lb GVW	
R	02-04	SUNSTAR All Motorhome Chassis with 20,500 lb GVW to 22,000 lb GVW	
R	16-18	SUNSTAR LX All Motorhome Chassis with 16,000 lb GVW to 18,000 lb GVW	
R	16-18	SUNSTAR LX All Motorhome Chassis with 20,500 lb GVW to 22,000 lb GVW	
R	11-22	VISTA All Motorhome Chassis with 16,000 lb GVW to 18,000 lb GVW	
R	11-22	VISTA All Motorhome Chassis with 20,500 lb GVW to 22,000 lb GVW	
R	08-09	VISTA All Motorhome Chassis with 16,000 lb GVW to 18,000 lb GVW	
R	07-09	VISTA All Motorhome Chassis with 20,500 lb GVW to 22,000 lb GVW	
R	02-04	VISTA All Motorhome Chassis with 20,500 lb GVW to 22,000 lb GVW	

Numerical listing

Shock	POP	Alternative No.	MTG Acc. Supplied
Pos.	Year	Application	
83122	W	(cont)	
R	16-18	VISTA LX	All Motorhome Chassis with 16,000 lb GVW to 18,000 lb GVW
R	16-18	VISTA LX	All Motorhome Chassis with 20,500 lb GVW to 22,000 lb GVW
83123	C		
R	00-03	FORD F-650	All Models with Hendrickson HAS - 190 Rear Air Suspension
R	13-24	KENWORTH K270	All Models with Hendrickson HAS - 210L or HAS - 230L Rear Air Suspension
R	93-05	K300	All Models with Hendrickson Rear Air Suspension
R	08-23	T270	All Models with Hendrickson HAS - 210L or HAS - 230L Rear Air Suspension
R	95-08	T300	All Models with Hendrickson HAS - 210L or HAS - 230L Rear Air Suspension
R	13-24	PETERBILT 220	All Models with Hendrickson HAS - 210L or HAS - 230L Rear Air Suspension
R	10	220	All Models with Hendrickson HAS - 210L or HAS - 230L Rear Air Suspension
R	07	220	All Models with Hendrickson HAS - 210L or HAS - 230L Rear Air Suspension
83124	C		
F		COACHMEN CLASS A	MOTORHOMES
F		FOREST RIVER CLASS A	MOTORHOMES
F		GEORGIE BOY MANUFACTURING	CLASS A MOTORHOMES
F		ITASCA CLASS A	MOTORHOMES
F		MONACO COACH CLASS A	MOTORHOMES
F		WORKHORSE	VARIOUS
83126	D		
F	69-70	CHEVROLET 4, 40, 4000 & 4500 SERIES	
R	71-72	5, 50, 5000 & 5500 SERIES	
F	69-70	5, 50, 5000 & 5500 SERIES	
R	02-23	FREIGHTLINER M2 106	All Models with Reyco 79KB Rear Steel Spring Suspension
F	72-80	GMC 4500 SERIES	
R	66-72	4500 SERIES	
F	66-89	5500 SERIES	
R	66-72	5500 SERIES	
F	79-80	6000 SERIES	
F	66-80	6500 SERIES	
R	66-80	6500 SERIES	
F	05-10	HINO 145	All Models with O.E.M. Number
F	05-10	165	All Models with O.E.M. Number
F	05-10	185	All Models with O.E.M. Number
R	13-24	KENWORTH K270	All Models with Reyco 102 or 79KB Suspension (Drive Axle)
R	93-05	K300	All Models with Reyco 102 or 79KB Suspension (Drive Axle)
F	93-05	K300	All Models with Reyco 1209 or 1212 Suspension (Steer Axle)
R	08-22	T170	All Models with Reyco 79KB Rear Steel Spring Suspension
R	08-23	T270	All Models with Reyco 102 or 79KB Suspension (Drive Axle)
R	21-24	T280	All Models with Reyco 102 or 79KB Suspension (Drive Axle)
F		T300	
R		T300	
R	99-08	T300	All Models with Reyco 102 or 79KB Suspension (Drive Axle)
R	99-08	T300	All Models with Reyco 1209 or 1212 Suspension (Steer Axle)
R	08-15	PETERBILT 210	All Models with Reyco 102 or 79KB Suspension (Drive Axle)
R	13-24	220	All Models with Reyco 102 or 79KB Suspension (Drive Axle)
R	10	220	All Models with Reyco 102 or 79KB Suspension (Drive Axle)
R	07	220	All Models with Reyco 102 or 79KB Suspension (Drive Axle)
R	08-19	325	All Models with Reyco 102 or 79KB Suspension (Drive Axle)

83000 Series

Shock	POP	Alternative No.	MTG Acc. Supplied
Pos.	Year	Application	
83127	C		
F		FREIGHTLINER VARIOUS	
R		HOLIDAY RAMBLER VARIOUS	
F	23	MACK MD6	
F	24	MD6	All Models with 10,000 lb Taperleaf Springs
F	21-22	MD6	All Models with 10,000 lb Taperleaf Springs
83131	W		
F	00-02	FORD F-650	All Models with 8500 or 9000 lb Front Axle
83134	W	145054 (1)	
R	05-21	FREIGHTLINER M2	All Models with Rear 52" Spring, 10000 lb - 15000 lb
R	05-21	M2	All Models with Rear 52" Spring, 18000 lb - 23000 lb
R	02-10	M2 100	All Models with Rear 52" Spring, 10000 lb - 15000 lb
R	02-10	M2 100	All Models with Rear 52" Spring, 18000 lb - 23000 lb
R	02-25	M2 106	All Models with Rear 52" Spring, 10000 lb - 15000 lb, 18,000-23,000 lb Springs
R	02-25	M2 106	All Models with Rear 52" Spring, 18000 lb - 23000 lb
R	02-23	M2 106	All Models with Rear 52" Spring, 10000 lb - 15000 lb
83135	C		
F	22-25	CHEVROLET 4500HD	
F	22-25	5500HD	
F	22-25	6500HD	
F	19-22	SILVERADO 4500 HD	All Models with 7,000 to 8,000 lb Front Axle
F	19-22	SILVERADO 5500 HD	All Models with 7,000 to 8,000 lb Front Axle
F	19-22	SILVERADO 6500 HD	All Models with 7,000 to 8,000 lb Front Axle
F	14	FORD F-650	
F	15	F-650	All Models with 8,500 lb Front Suspension
F	00-13	F-650	All Models with 8,500 lb Front Suspension
F	02-20	INTERNATIONAL 4300	All Models with 6,000 to 8,000 lb Front Suspension
F	02-20	4400	All Models with 6,000 to 8,000 lb Front Suspension
F	10-12	DURASTAR - 4300	4400 SERIES
F	12-18	TERRASTAR	All Models with 6,000 to 7,000 lb Front Axle
83136	W	145054 (2)	
F		CHAMPION BUS INC.	VARIOUS
F	90-96	CHEVROLET C60 KODIAK	All Conventional Cab w/ Front Shock with O.E.M. Number
R	90-96	C60 KODIAK	All Conventional Cab w/19000, 21000, 23000 lb Taperleaf Springs (EXC Low Profile Vehicle)
F	90-02	C4500 KODIAK	
R	90-02	C4500 KODIAK	
F	03-09	C4500 KODIAK	All C Chassis - Conventional Cab
R	03-09	C4500 KODIAK	All C Chassis - Conventional Cab w/19000, 21000, 23000 lb Taperleaf Springs (EXC Low Profile Vehicle)
F	92-02	C5500 KODIAK	
R	92-02	C5500 KODIAK	
F	03-09	C5500 KODIAK	All C Chassis - Conventional Cab
R	03-09	C5500 KODIAK	All C Chassis - Conventional Cab w/19000, 21000, 23000 lb Taperleaf Springs (EXC Low Profile Vehicle)
F	90-91	C5500 KODIAK	All C Chassis - Conventional Cab
R	90-91	C5500 KODIAK	All C Chassis - Conventional Cab w/19000, 21000, 23000 lb Taperleaf Springs (EXC Low Profile Vehicle)
F	97-09	C6500 KODIAK	All Conventional Cab w/ Front Shock with O.E.M. Number
R	97-09	C6500 KODIAK	All Conventional Cab w/19000, 21000, 23000 lb Taperleaf Springs (EXC Low Profile Vehicle)
F	00-01	C7500 KODIAK	All Conventional Cab w/ Front Shock with O.E.M. Number

Numerical listing

Shock	POP	Alternative No.	MTG Acc. Supplied
Pos.	Year	Application	
83136	W	(cont)	
R	00-01	C7500 KODIAK	All Conventional Cab w/19000, 21000, 23000 lb Taperleaf Springs (EXC Low Profile Vehicle)
F		C - SERIES (C6500, C7500, C8500)	KODIAK
R	92-96	P60	All Motorhome Chassis
R	92-96	P6000	All Motorhome Chassis
F	97-09	T5500	
R	92-99	T5500	
F	03	T6500	
R	92-96	T6500	
F	04-09	T6500	All FL1 Tilt Cab with 8100 lb Axle
F	04-09	T6500	All FL2 Tilt Cab with 5000 to 11000 lb Axle
F	04-09	T6500	All FL3 Tilt Cab with 14575 lb Axle
R	00-02	T6500	All Tilt Cab with 23,000 lb Axles; Tapered Leaf Spring
F	97-02	T6500	All FL1 Tilt Cab with 8100 lb Axle
F	97-02	T6500	All FL2 Tilt Cab with 5000 to 11000 lb Axle
F	97-02	T6500	All FL3 Tilt Cab with 14575 lb Axle
R	97-99	T6500	All Tilt Cab w/19000, 21000, 23000 lb Taperleaf Springs (EXC Low Profile Veh.)
F	04-09	T7500	All FL1 Tilt Cab with 8100 lb Axle
F	04-09	T7500	All FL2 Tilt Cab with 5000 to 11000 lb Axle
F	04-09	T7500	All FL3 Tilt Cab with 14575 lb Axle
R	00-02	T7500	All Tilt Cab with 23,000 lb Axles; Tapered Leaf Spring
F	97-02	T7500	All FL1 Tilt Cab with 8100 lb Axle
F	97-02	T7500	All FL2 Tilt Cab with 5000 to 11000 lb Axle
F	97-02	T7500	All FL3 Tilt Cab with 14575 lb Axle
R	97-99	T7500	All Tilt Cab w/19000, 21000, 23000 lb Taperleaf Springs (EXC Low Profile Veh.)
F	04-09	T8500	All FL1 Tilt Cab with 8100 lb Axle
F	04-09	T8500	All FL2 Tilt Cab with 5000 to 11000 lb Axle
F	04-09	T8500	All FL3 Tilt Cab with 14575 lb Axle
R	92-96	VAN 1 TON, P SERIES	All Motorhome Chassis
F	90-02	GMC C4500 TOPKICK	
R	90-02	C4500 TOPKICK	
R	03-09	C4500 TOPKICK	All C Chassis - Conventional Cab with 19000, 21000, 23000 lb Taperleaf Springs (EXC Low Profile Vehicle)
F	03-09	C4500 TOPKICK	All C Chassis - Conventional Cab with Front Shock with O.E.M. Number
F	90-02	C5500 TOPKICK	
R	90-02	C5500 TOPKICK	
R	03-09	C5500 TOPKICK	All C Chassis - Conventional Cab with 19000, 21000, 23000 lb Taperleaf Springs (EXC Low Profile Vehicle)
F	03-09	C5500 TOPKICK	All C Chassis - Conventional Cab with Front Shock with O.E.M. Number
F	90-09	C - SERIES (C6500, C7500, C8500)	TOPKICK
R	90-09	C - SERIES (C6500, C7500, C8500)	TOPKICK
R	92-96	P - SERIES	
F	97-09	T5500	
R	92-99	T5500	
F	03	T6500	
R	92-96	T6500	
F	04-09	T6500	All FL1 Tilt Cab with 8100 lb Axle
F	04-09	T6500	All FL2 Tilt Cab with 5000 to 11000 lb Axle
F	04-09	T6500	All FL3 Tilt Cab with 14575 lb Axle
R	00-02	T6500	All Tilt Cab with 23,000 lb Axles; Tapered Leaf Spring
F	97-02	T6500	All FL1 Tilt Cab with 8100 lb Axle
F	97-02	T6500	All FL2 Tilt Cab with 5000 to 11000 lb Axle

Numerical listing

Shock	POP	Alternative No.	MTG Acc. Supplied
Pos.	Year	Application	
83136	W	(cont)	145054 (2)
F	97-02	T6500 All FL3 Tilt Cab with 14575 lb Axle	
R	97-99	T6500 All Tilt Cab with 19000, 21000, 23000 lb Taperleaf Springs (EXC Low Profile Veh.)	
F	04-09	T7500 All FL1 Tilt Cab with 8100 lb Axle	
F	04-09	T7500 All FL2 Tilt Cab with 5000 to 11000 lb Axle	
F	04-09	T7500 All FL3 Tilt Cab with 14575 lb Axle	
R	00-02	T7500 All Tilt Cab with 23,000 lb Axles; Tapered Leaf Spring	
F	97-02	T7500 All FL1 Tilt Cab with 8100 lb Axle	
F	97-02	T7500 All FL2 Tilt Cab with 5000 to 11000 lb Axle	
F	97-02	T7500 All FL3 Tilt Cab with 14575 lb Axle	
R	97-99	T7500 All Tilt Cab with 19000, 21000, 23000 lb Taperleaf Springs (EXC Low Profile Veh.)	
F	04-07	GULF STREAM ENDURA	
F	08	ENDURA All MotorHomes with Chevy Kodiak Chassis	
R	97-09	ISUZU FTR All Models with 19000, 21000, 23000 lb Taperleaf Springs (EXC Low Profile Veh.)	
F	90-09	FTR All Models with O.E.M. Number	
F	05-08	HVR All Conventional Cab with OEM Number;	
R	93-05	KENWORTH K300 All Models with Woodhead Shock (Stamping Number ACHB 966)	
R		T300	
83137	W		
R	97-09	CHEVROLET C6500 KODIAK All Models with Hendrickson Air Suspension with O.E.M. Number	
R	00-01	C7500 KODIAK All Models with Hendrickson Air Suspension with O.E.M. Number	
R	18-24	ISUZU FTR All Models with Hendrickson HAS suspension	
R	00-11	FTR All Models with Hendrickson HAS suspension	
R	13-24	KENWORTH K270 All Models with Hendrickson HAS - 230 Rear Air Suspension	
R	08-14	T270 All Models with Hendrickson HAS - 400 (Standard) Rear Air Suspension	
83140	D		415010-802(2)/145148(2)
R	00-03	FORD F-650 All Models with 23,000 lb Multi-leaf Rear Springs	
F	05-10	HINO 185 All Models with O.E.M. Number	
F	05-14	238 All Models with O.E.M. Number	
F	06-14	258 All Models with O.E.M. Number	
F	05-14	268 All Models with O.E.M. Number	
F	08-14	268A All Models with O.E.M. Number	
83141	W		415010-802(2)/145148(2)
F	98-04	HINO FB1817 All FE Models Trucks with:	
F	98-04	FE SERIES	
83142	C		145128 (1)
R	05-21	FREIGHTLINER M2 All Models with Hendrickson HMX 400/460 Haulmax with 17.5" & 18.5" Saddle	
R	02-10	M2 100 All Models with Hendrickson HMX 400/460 Haulmax with 17.5" & 18.5" Saddle	
R	02-25	M2 106 All Models with Hendrickson HMX 400/460 Haulmax with 17.5" & 18.5" Saddle	
R	19-23	PIERCE MFG. INC. VARIOUS	
83143	D		145128 (1)
R	05-21	FREIGHTLINER M2 All Models with Hendrickson HMX 400/460 Haulmax with 16.5" Saddle	
R	02-10	M2 100 All Models with Hendrickson HMX 400/460 Haulmax with 16.5" Saddle	
R	02-25	M2 106 All Models with Hendrickson HMX 400/460 Haulmax with 16.5" Saddle	

83000 Series

Shock	POP	Alternative No.	MTG Acc. Supplied
Pos.	Year	Application	
83143	D	(cont)	145128 (1)
R	08-23	KENWORTH T270 All Models with Hendrickson HMX 400/460 Haulmax with 16.5" Saddle	
R	19-23	PIERCE MFG. INC. VARIOUS	
83144	W		
F	00-03	HOLIDAY RAMBLER CLASS A MOTORHOMES	
F	00-07	MONACO COACH CLASS A MOTORHOMES	
83147	C		
R		THOMAS VARIOUS	
83148	D		
R	20	FORD F-650	
R	21-24	F-650 All Models with Hendrickson Rear Air Suspension	
R	15-19	F-650 All Models with Hendrickson Rear Air Suspension	
R		HINO ADDITIONAL APPLICATIONS	
83154	D		145089-000 (1)
R	98-23	FREIGHTLINER MT45 All Walkin Step Van Models (18 Foot) with O.E.M. Number	
R		MT55	
R	00-02	XCS CHASSIS	
83157	W		
F	99-20	FREIGHTLINER MT45 All MT45 Step Van - w/35" Front Spring	
F	99-20	MT55 All MT55 Step Van - w/35" Front Spring	
83159	W		TR0027 (4)
R	24-25	CHEVROLET LCF 3500	
R	16-23	LCF 3500 All	
R	18	LCF 3500HD	
R	16-17	LCF 3500HD All	
R	17-25	LCF 4500 All	
R	17-25	LCF 4500HD All	
R	25	LCF 5500XD	
R	17-24	LCF 5500XD All	
R	17-24	LCF 5500XD All With OEM Number 983439850	
R	19-22	SILVERADO 4500 HD All Diesel Low Cab Forward models with 14,000 to 15,000 lb Rear	
R	19-22	SILVERADO 4500 HD All Diesel Low Cab Forward models with 15,000 to 16,000 lb Rear	
R	19-22	SILVERADO 5500 HD All Diesel Low Cab Forward models with 14,000 to 15,000 lb Rear	
R	19-22	SILVERADO 5500 HD All Diesel Low Cab Forward models with 15,000 to 16,000 lb Rear	
R	00-10	GMC W4500 FORWARD All Models with 11000 lb and 13000 lb Suspension	
R	00-09	W5500 FORWARD All Models with 11000 lb and 13000 lb Suspension W - SERIES (ISUZU)	
R	05-09	ISUZU FTR All Models with O.E.M. Number	
R	95-20	NPR All Models with O.E.M. Number	
R	20-23	NPR-HD All Models with 14,000 to 15,000 lb Rear	
R	20-23	NPR-HD All Models with 15,000 to 16,000 lb Rear	
R	03-23	NPR-HD All Models with O.E.M. Number	
R	23	NPR-XD	
R	15-22	NPR-XD All Models with 14,000 to 15,000 lb GVW	
R	15-22	NPR-XD All Models with 15,000 to 16,000 lb Rear	
R	20-23	NQR All Models with 15,000 to 16,000 lb Rear	
R	03-19	NQR All Models with O.E.M. Number	
R	02	NQR All Diesel	
R	95-97	NQR All Diesel	
R	20-23	NRR All Models with 15,000 to 16,000 lb Rear	
R	05-19	NRR All Models with O.E.M. Number	
R	11-15	REACH All Models with O.E.M. Number	
83160	W		
F	06	COACHMEN CROSS COUNTRY	
F	03-05	CROSS COUNTRY ELITE	

Numerical listing

Shock	POP	Alternative No.	MTG Acc. Supplied
Pos.	Year	Application	
83160	W	(cont)	
F	03-05	CROSS COUNTRY SE	
F	02-04	FOREST RIVER REFLECTION	
F	02-06	TSUNAMI	
F	93-07	FREIGHTLINER VC CHASSIS	
F		XB CHASSIS	
F		XC CHASSIS	
F	93-12	XC CHASSIS	
F	01-02	XCS CHASSIS	
F	03-06	GULF STREAM ATRIUM	
F	02-06	FRIENDSHIP	
F	02	INDEPENDENCE All MotorHomes with Freightliner XC Chassis and AS120 Front Suspension	
F	02-06	SCENIC CRUISER	
F	02-04	YELLOWSTONE	
F	95-99	HOLIDAY RAMBLER CLASS A MOTORHOMES	
F	02-06	ITASCA CLASS A MOTORHOMES	
F	04-06	KING OF THE ROAD CLASS A MOTORHOMES	
F	04-06	MANDALAY COACH CLASS A MOTORHOMES	
F	95-99	MONACO COACH VARIOUS	
F	02-06	NEWMAR CLASS A MOTORHOMES	
F	02-06	THOR MOTOR COACH CLASS A MOTORHOMES	
F	02-06	WINNEBAGO JOURNEY All MotorHomes with Freightliner XC Chassis and AS120 Front Suspension	
F	06	TOUR All MotorHomes with Freightliner XC Chassis and AS120 Front Suspension	
F	06	VECTRA All MotorHomes with Freightliner XC Chassis and AS120 Front Suspension	
83162	W		140780(1)/145116 & 406422 & 415010-802(1)
F	87-93	ISUZU EVR All EVR Models	
F	86	FSR	
F	89-13	UD 2600 All Models with O.E.M. Number	
83163	B		
F	00-02	CHEVROLET T6500 All Low profile, with Axle Code FL1	
F	00-02	T7500 All Low profile, with Axle Code FL1	
F	00-02	GMC T6500 All Low profile, with Axle Code FL1	
F	00-02	T7500 All Low profile, with Axle Code FL1	
F	08-09	INTERNATIONAL 4300 All Models with 9,000 to 10,000 lb Front Suspension	
F	08-09	4400 All Models with 9,000 to 10,000 lb Front Suspension	
F	15-19	DURASTAR All Models with 9,000 to 10,000 lb Front Suspension	
F	13	DURASTAR All Models with 9,000 to 10,000 lb Front Suspension	
F	19-22	MV607 All Models with 9,000 to 10,000 lb Front Suspension	
F	20	MV All Models with 9,000 to 10,000 lb Front Suspension	
F	19-22	PIERCE MFG. INC. VARIOUS	
83164	W		
F		FREIGHTLINER MP 14	
F		MP 19	
F	99-20	MT45 All MT45 Step Van - w/38" Front Spring	
F	99-20	MT55 All MT55 Step Van - w/38" Front Spring	
83166	W		
R	08-14	HINO 238 All Models with Hendrickson Comfort Air (Single Axle - 19K)	
R	08-20	258 All Models with Hendrickson Comfort Air (Single Axle - 19K)	
R	08-14	258ALP All Models with Hendrickson Comfort Air (Single Axle - 19K)	
R	08-20	268 All Models with Hendrickson Comfort Air (Single Axle - 19K)	
R	08-14	268A All Models with Hendrickson Comfort Air (Single Axle - 19K)	
R	22-24	L6	
R	21-24	L6 All Models with Hendrickson Comfort Air (Single Axle - 19K, 21K & 23K)	

Numerical listing

Shock	POP	Alternative No.	MTG Acc. Supplied
Pos.	Year	Application	
83166	W	(cont)	
R	21	L6	All Models with Hendrickson Comfort Air (Single Axle - 19K)
R	20-24	ISUZU FTR	All Models with Hendrickson Comfort Air (Single Axle - 21K & 23K)
R	21-22	LION LION6	All Models with Hendrickson Comfort Air Suspension (21K Capacity)
83168	W		
R	21-24	FORD F-650	All Models with Hendrickson Rear Air Suspension
R	15-19	F-650	All Models with Hendrickson Rear Air Suspension
R		HINO 268, 268A	SERIES
83169	W		
F	15-20	INTERNATIONAL DURASTAR	All Models with 6,000 to 8,000 lb Front Suspension
F	13	DURASTAR	All Models with 6,000 to 8,000 lb Front Suspension
F	13-18	DURASTAR - 4300, 4400	SERIES
F	19-22	MV607	All Models with 6,000 to 8,000 lb Front Suspension
83175	W		
F	14	FORD F-650	
F	15	F-650	All Models with 10,000 lb Front Suspension
F	00-13	F-650	All Models with 10,000 lb Front Suspension
F	00-15	GLAVAL BUS CO.	CONCORDE II - SERIES
83180	W		
R	14	INTERNATIONAL TERRASTAR	All 4 WD Models with Rear Spring Suspension
83203	B		
	00-05	INTERNATIONAL 4700	All With OEM Number
	00-05	4900	All With OEM Number
83207	C		
F	73-80	CHEVROLET 5, 50, 5000 & 5500	SERIES
F	73-80	GMC 5000	SERIES
F	73-75	6000	SERIES
F	73-75	6500	SERIES
83209	D		
F	09	COACHMEN AURORA	
F	07	AURORA	
F	08	AURORA	All MotorHomes with Ford F53 Chassis with 16,000 lb GVW to 22,000 lb GVW
F	04-06	AURORA	All MotorHomes with Ford F53 Chassis with 16,000 lb GVW to 22,000 lb GVW
F	21-24	ENCORE	All MotorHomes with Ford F53 Chassis with 16,000 lb GVW to 22,000 lb GVW
F	11-16	ENCOUNTER	All MotorHomes with Ford F53 Chassis with 16,000 lb GVW to 22,000 lb GVW
F	99-07	MIRADA	
F	08-24	MIRADA	All MotorHomes with Ford F53 Chassis with 16,000 lb GVW to 22,000 lb GVW
F	04-12	PURSUIT	
F	13-24	PURSUIT	All MotorHomes with Ford F53 Chassis with 16,000 lb GVW to 22,000 lb GVW
F	12-13	DAMON DAYBREAK	
F	99	DAYBREAK	
F	99	INTRUDER	
F	12-14	OUTLAW	
F	19-20	FLEETWOOD AXON	
F	06-23	FORD F-53	
F	99-04	F-53	
F	88-97	F-53	
F	05	F-53	MOTORHOME CHASSIS
F	98	F-53	MOTORHOME CHASSIS
F	13-24	FOREST RIVER FR3	All MotorHomes with Ford F53 Chassis with 16,000 lb GVW to 22,000 lb GVW
F	08-17	GEORGETOWN	All MotorHomes with Ford F53 Chassis with 16,000 lb GVW to 22,000 lb GVW

83000 Series

Shock	POP	Alternative No.	MTG Acc. Supplied
Pos.	Year	Application	
83209	D	(cont)	
F	16-24	GEORGETOWN GT3	All MotorHomes with Ford F53 Chassis with 16,000 lb GVW to 22,000 lb GVW
F	17-24	GEORGETOWN GT5	All MotorHomes with Ford F53 Chassis with 16,000 lb GVW to 22,000 lb GVW
F	20-24	GEORGETOWN GT7	All MotorHomes with Ford F53 Chassis with 16,000 lb GVW to 22,000 lb GVW
F	99-09	GEORGIE BOY MANUFACTURING CLASS A MOTORHOMES	
F	11-15	HOLIDAY RAMBLER ADMIRAL	
F	02-06	ADMIRAL	
F	16-24	ADMIRAL	All MotorHomes with Ford F53 Chassis with 16,000 lb GVW to 22,000 lb GVW
F	07-10	ADMIRAL	All MotorHomes with Ford F53 Chassis with 16,000 lb GVW to 22,000 lb GVW
F	00-01	ADMIRAL	All MotorHomes with Ford F53 Chassis with 16,000 lb GVW to 22,000 lb GVW
F	02-06	ADMIRAL SE	All MotorHomes with Ford F53 Chassis with 16,000 lb GVW to 22,000 lb GVW
F	07	ADMIRAL SVE	All MotorHomes with Ford F53 Chassis with 16,000 lb GVW to 22,000 lb GVW
F	16-18	ADMIRAL XE	All MotorHomes with Ford F53 Chassis with 16,000 lb GVW to 22,000 lb GVW
F	23-24	ECLIPSE	All MotorHomes with Ford F53 Chassis with 16,000 lb GVW to 22,000 lb GVW
F	15	ENDEAVOR	
F	16-24	ENDEAVOR	All MotorHomes with Ford F53 Chassis with 16,000 lb GVW to 22,000 lb GVW
F	00-14	ENDEAVOR	All MotorHomes with Ford F53 Chassis with 16,000 lb GVW to 22,000 lb GVW
F	11-24	VACATIONER	All MotorHomes with Ford F53 Chassis with 16,000 lb GVW to 22,000 lb GVW
F	09	VACATIONER	All MotorHomes with Ford F53 Chassis with 16,000 lb GVW to 22,000 lb GVW
F	00-07	VACATIONER	All MotorHomes with Ford F53 Chassis with 16,000 lb GVW to 22,000 lb GVW
F	99-15	ITASCA CLASS A MOTORHOMES	
F	16-24	JAYCO ALANTE	All MotorHomes with Ford F53 Chassis with 16,000 lb GVW to 22,000 lb GVW
F	14-24	PRECEPT	All MotorHomes with Ford F53 Chassis with 16,000 lb GVW to 22,000 lb GVW
F	07-08	MONACO COACH LA PALMA	
F	01	LA PALMA	
F	90-99	LA PALMA	
F	03-05	MONARCH	
F	90-99	MONARCH	
F	99-08	NATIONAL RV CLASS A MOTORHOMES	
F	24	NEWMAR BAY STAR 3626	F53 Chassis with 16,000 lb GVW to 22,000 lb GVW
F	13-20	CLASS A	MOTORHOMES
F	17-20	NEXUS MAYBACH	All MotorHomes with Ford F53 Chassis with 16,000 lb GVW to 22,000 lb GVW
F	11-24	THOR MOTOR COACH A.C.E.	All MotorHomes with Ford F53 Chassis with 16,000 lb GVW to 22,000 lb GVW
F	05-08	CHALLENGER	
F	09-24	CHALLENGER	All MotorHomes with Ford F53 Chassis with 16,000 lb GVW to 22,000 lb GVW
F	04-10	HURRICANE	
F	11-24	HURRICANE	All MotorHomes with Ford F53 Chassis with 16,000 lb GVW to 22,000 lb GVW
F	23-24	INDIGO	All MotorHomes with Ford F53 Chassis with 16,000 lb GVW to 22,000 lb GVW
F	23-24	LUMINATE	All MotorHomes with Ford F53 Chassis with 16,000 lb GVW to 22,000 lb GVW

Numerical listing

Shock	POP	Alternative No.	MTG Acc. Supplied
Pos.	Year	Application	
83209	D	(cont)	
F	14-24	MIRAMAR	All MotorHomes with Ford F53 Chassis with 16,000 lb GVW to 22,000 lb GVW
F	07-10	OUTLAW	
F	11-23	OUTLAW	All MotorHomes with Ford F53 Chassis with 16,000 lb GVW to 22,000 lb GVW
F	23-24	RESONATE	All MotorHomes with Ford F53 Chassis with 16,000 lb GVW to 22,000 lb GVW
F	06-10	WINDSPORT	
F	11-24	WINDSPORT	All MotorHomes with Ford F53 Chassis with 16,000 lb GVW to 22,000 lb GVW
F	25	TIFFIN ALLEGRO OPEN ROAD 34PA	F53 Chassis with 16,000 lb GVW to 22,000 lb GVW
F	19-23	WINNEBAGO ADVENTURER	All MotorHomes with Ford F53 Chassis with 16,000 lb GVW to 22,000 lb GVW
F	92-17	ADVENTURER	All MotorHomes with Ford F53 Chassis with 16,000 lb GVW to 22,000 lb GVW
F	18-20	INTENT	All MotorHomes with Ford F53 Chassis with 16,000 lb GVW to 22,000 lb GVW
F	02-17	SIGHTSEER	All MotorHomes with Ford F53 Chassis with 16,000 lb GVW to 22,000 lb GVW
F	16-17	SUNOVA	All MotorHomes with Ford F53 Chassis with 16,000 lb GVW to 22,000 lb GVW
F	02-07	SUNOVA	All MotorHomes with Ford F53 Chassis with 16,000 lb GVW to 22,000 lb GVW
F	16-22	SUNSTAR	All MotorHomes with Ford F53 Chassis with 16,000 lb GVW to 22,000 lb GVW
F	02-04	SUNSTAR	All MotorHomes with Ford F53 Chassis with 16,000 lb GVW to 22,000 lb GVW
F	16-18	SUNSTAR LX	All MotorHomes with Ford F53 Chassis with 16,000 lb GVW to 22,000 lb GVW
F	07-22	VISTA	All MotorHomes with Ford F53 Chassis with 16,000 lb GVW to 22,000 lb GVW
F	02-04	VISTA	All MotorHomes with Ford F53 Chassis with 16,000 lb GVW to 22,000 lb GVW
F	16-18	VISTA LX	All MotorHomes with Ford F53 Chassis with 16,000 lb GVW to 22,000 lb GVW
83215	W	401754 (4)	
R	86-94	FORD F-600	All Models with O.E.M. Number
R	80-90	F-600	All Models with 17000 & 18000 lb Rear Axle
R	86-87	HINO FD16	All Models with O.E.M. Number
R	88-92	FD17	All Models with O.E.M. Number
R	93-97	FD2218	All (FD5H). FE5H, FF5H
R	93-97	FD2218LD	
R	93-97	FD2218LP	All Models with O.E.M. Number
R	98	FE2620	All
83216	W	140149 (1)	
F	66-72	GMC 4500	SERIES
F	66-72	5500	SERIES
F	66-75	6500	SERIES
R	89-91	HINO FA14	All FA, FB Models Trucks with:
R	92	FA15	All FA, FB Models Trucks with:
R	93-97	FA1415	All (FA15)
R	93-97	FA1415	All FA, FB Models Trucks with:
R	93-97	FA1415	All FA1415 (FA15), FB1715 (FB15)
R	98-04	FA1517	All FA, FB Models Trucks with:
R	98	FA1517	All
R	98	FA1517	All FA1517, FA1817, FB1817
R	98	FA1817	
R	89-91	FB14	All FA, FB Models Trucks with:
R	92	FB15	All FA, FB Models Trucks with:

Numerical listing

Shock	POP	Alternative No.	MTG Acc. Supplied
Pos.	Year	Application	
83216	W	(cont)	140149 (1)
R	93-97	FB1715 All FA, FB Models Trucks with:	
R	93-97	FB1715 All FA1415 (FA15), FB1715 (FB15)	
R	98-04	FB1817 All FA, FB Models Trucks with:	
R	98	FB1817 All	
R	98	FB1817 All FA1517, FA1817, FB1817	
F	93-97	FD2218 All (FD5H), FE5H, FF5H	
F	93-97	FD2218LP All Models with O.E.M. Number	
F	86-87	FE16 All	
F	90-91	GC17 All GC17	
F	92	GC20 All GC20	
R		INTERNATIONAL A, B, AC AND BC CONVENTIONAL BINDER CARGOSTAR	
83221	W		
F	67-72	CHEVROLET 4, 40, 4000 & 4500 SERIES	
R	67-68	4, 40, 4000 & 4500 SERIES	
R	76-89	5, 50, 5000 & 5500 SERIES	
F	75-80	5, 50, 5000 & 5500 SERIES	
F	68-72	5, 50, 5000 & 5500 SERIES	
R	63-69	5, 50, 5000 & 5500 SERIES	
R	83-99	C4500 KODIAK	
R	92-99	C5500 KODIAK	
R	83-89	C5500 KODIAK	
R	90-91	C5500 KODIAK All C Chassis - Conventional Cab with 9100 to 17500 lb Rear Axle	
R	97-99	C6500 KODIAK All Conventional Cab with 9100 to 17500 lb Rear Axle	
R	60-66	GMC 3500 & 4000 SERIES	
R	72-80	4500 SERIES	
F	66-72	4500 SERIES	
R	76-89	5000 SERIES	
F	75-80	5000 SERIES	
R	60-62	5000 SERIES	
F	66-72	5500 SERIES	
R	66-80	6500 SERIES	
F	75-76	6500 SERIES	
F	66-72	6500 SERIES	
R	83-99	C - SERIES (C4500, C5500) TOPKICK	
R	83-99	C - SERIES (C6500, C7500, C8500) TOPKICK	
F		WORKHORSE VARIOUS	
83225	W		401754 (4)
R	70-90	FORD F-600 All Models with 13000 & 15000 lb Rear Axle	
R	80-85	LN600 All Models with 11000, 13000, 15000, 17000 lb Axles	
R		INTERNATIONAL A, B, AC AND BC CONVENTIONAL CARGOSTAR	
83243	W		
R	25	CHEVROLET SILVERADO 4500HD	
R	22-24	SILVERADO 4500 HD All Models with 4X4 Rear	
R	19-21	SILVERADO 4500 HD All Models with 4 x 4 Rear	
R	25	SILVERADO 5500HD	
R	23-24	SILVERADO 5500 HD All Models with 4X4 Rear	
R	19-22	SILVERADO 5500 HD All Models with 4 x 4 Rear	
R	25	SILVERADO 6500HD	
R	23-24	SILVERADO 6500 HD All Models with 4X4 Rear	
R	19-22	SILVERADO 6500 HD All Models with 4 x 4 Rear	
R	19-23	INTERNATIONAL CV515 All Models with 4 x 4 Rear	
83303	W		140702 (1)
F	72-80	GMC 4500 SERIES	
F	79-80	6000 SERIES	
F	75-89	6500 SERIES	
83308	W		140149 (1)
F	80-86	FORD C600 All Models with 3100 lb Spring and 7000 lb Axle	
F	80-85	LN600 All Models with 3000, 3300 lb Springs and 5000, 5500, 6000, 7000 lb Axles	

83000 Series

Shock	POP	Alternative No.	MTG Acc. Supplied
Pos.	Year	Application	
83309	W		140149 (1)
F	80-94	FORD F-600 All Exc. 9000 lb Axle with H.D. Suspension & 12000 lb Axle	
F	90	F-600 All Models with Multileaf Spring	
F		INTERNATIONAL CARGOSTAR	
83312	W		140149 (1)
F	80-86	FORD C600 All Models with 4040, 5040 lb Springs and 7000, 9000, 12000 lb Axles	
F	80-85	LN600 All Models with 4400 lb Spring and 7000, 9000 lb Axles	
F	93-05	KENWORTH K300 All Models with Multiple Leaf Springs on Front Axle (3/4" Mounting bolts) T300	
83314	W		140149 (1)
F	83-89	FORD F-600 All Models with 9000 lb Axle with H.D. Suspension & 12000 lb Axle	
F		INTERNATIONAL CARGOSTAR	
83317	W		141083 (1)
R	14	FORD F-650	
R	15	F-650 All Models with 22,000 lb Multi-leaf Rear Springs	
R	04-13	F-650 All Models with 22,000 lb Multi-leaf Rear Springs	
R	04-15	GLAVAL BUS CO. CONCORDE II - SERIES	
R	02-13	INTERNATIONAL 4300 All Models with 22,000 lb Rear Spring Suspension	
R	02-10	4300 All With OEM Number	
R	02-13	4400 All Models with 22,000 lb Rear Spring Suspension	
R	13	DURASTAR All Models with 22,000 lb Rear Spring Suspension	
83364	W		
R	06-09	FORD LCF450	
R	06-09	LCF550	
R	06-09	INTERNATIONAL CF500 All w/ vari-rate suspension	
R	16-20	DURASTAR All Models with 10,500 or 13,500 lb Vari-Rate Rear Spring Suspension	
R	12-18	TERRASTAR All Models with 10,500 or 13,500 lb Vari-Rate Rear Spring Suspension	
83391	W		145177 (2)
F	15-20	HINO 258 All Models with O.E.M. Number	
F	15-20	258LP All Models with O.E.M. Number	
F	15-20	268 All Models with O.E.M. Number	
F	22-24	L6	
F	21	L6 All Models with O.E.M. Number	
83395	W		145054 (1)
R	16-17	INTERNATIONAL DURASTAR All Models with Vari-Rate Rear Spring Suspension	
83397	W		
F	25	CHEVROLET SILVERADO 4500HD	
F	19-24	SILVERADO 4500 HD All Models with Taperleaf Front	
F	25	SILVERADO 5500HD	
F	19-24	SILVERADO 5500 HD All Models with Taperleaf Front	
F	25	SILVERADO 6500HD	
F	19-24	SILVERADO 6500 HD All Models with Taperleaf Front	
F	24	INTERNATIONAL CV515	
F	19-23	CV515 All Models with Taperleaf Front	
83398	W		
R	25	CHEVROLET SILVERADO 4500HD	
R	19-24	SILVERADO 4500 HD All Models with 11K, 13.5K or 15.5K VARI-RATE Rear Suspension	
R	25	SILVERADO 5500HD	
R	19-24	SILVERADO 5500 HD All Models with 11K, 13.5K or 15.5K VARI-RATE Rear Suspension	
R	25	SILVERADO 6500HD	
R	19-24	SILVERADO 6500 HD All Models with 11K, 13.5K or 15.5K VARI-RATE Rear Suspension	
R	24	INTERNATIONAL CV515	

Numerical listing

Shock	POP	Alternative No.	MTG Acc. Supplied
Pos.	Year	Application	
83398	W	(cont)	
R	19-23	CV515 All Models with 11K, 13.5K or 15.5K VARI-RATE Rear Suspension	
83456	D		142998 (2)
F	00-05	INTERNATIONAL 4700 All With OEM Number	
F	00-05	4900 All With OEM Number	
F		SERIES 4000 - SHORT CONVENTIONAL MEDIUM TRK & TRAC	
F	90-02	SERIES 4000 - SHORT CONVENTIONAL MEDIUM TRK & TRAC	
F	86-88	MITSUBISHI FUSO FM All Models with O.E.M. Number	
83515	W		141041
F	24-25	CHEVROLET LCF 3500	
F	16-23	LCF 3500 All	
F	18	LCF 3500HD	
F	16-17	LCF 3500HD All	
F	17-25	LCF 4500 All With OEM Number	
F	17-25	LCF 4500HD All With OEM Number	
F	17-25	LCF 4500XD All With OEM Number	
F	25	LCF 5500XD	
F	17-24	LCF 5500XD All With OEM Number	
F	19-22	SILVERADO 4500 HD All Diesel Low Cab Forward models with 14,500 lb GVWR	
F	19-22	SILVERADO 4500 HD All Diesel Low Cab Forward models with 16,000 lb to 19,500 lb GVWR	
F	19-22	SILVERADO 5500 HD All Diesel Low Cab Forward models with 14,500 lb GVWR	
F	19-22	SILVERADO 5500 HD All Diesel Low Cab Forward models with 16,000 lb to 19,500 lb GVWR	
F	87-10	W4500 TILTMMASTER All Models with 11000 lb & 13000 lb Suspension	
F	88-10	W5500 TILTMMASTER All Models with 11000 lb & 13000 lb Suspension	
F	87-96	W6500 TILTMMASTER All Models with 11000 lb & 13000 lb Suspension	
F	00-08	GMC W3500 FORWARD All Models with 11000 lb and 13000 lb suspension	
F	92-10	W4500 FORWARD All Models with 11000 lb & 13000 lb Suspension	
F	88-10	W5500 FORWARD All Models with 11000 lb & 13000 lb Suspension	
F	87-96	W6500 FORWARD All Models with 11000 lb & 13000 lb Suspension	
F	85	ISUZU ADDITIONAL APPLICATIONS ALL MODELS WITH	
F	86	FSR	
F	05-09	FTR All Models with O.E.M. Number	
F	84-85	NPR	
F	86-20	NPR All Models with O.E.M. Number	
F	99-23	NPR-HD All Models with O.E.M. Number	
F	23	NPR-XD	
F	15-22	NPR-XD All Models with 14,000 to 15,000 lb GVW	
F	15-22	NPR-XD All Models with 15,000 to 16,000 lb GVW	
F	94-23	NQR All Models with O.E.M. Number	
F	05-23	NRR All Models with O.E.M. Number	
F	88-94	NRR All Models with O.E.M. Number	
F	11-15	REACH All Models with O.E.M. Number	
F	99-15	MITSUBISHI FIGHTER FM SERIES	
F	99-04	UD 1200 All Models with O.E.M. Number	
F	05-07	1300 All Models with O.E.M. Number	
F	94-10	1400 All Models with O.E.M. Number	
83518	W		141041 (1)/TR0027 (2)
F	13-20	HINO 155 All Models with O.E.M. Number	
F	21	195	
F	12-20	195 All Models with O.E.M. Number	

Numerical listing

Shock	POP	Alternative No.	MTG Acc. Supplied
Pos.	Year	Application	
83519	W	401011 (4)	
R	13-20	HINO 155 All Models with O.E.M. Number	
R	21	195	
R	12-20	195 All Models with O.E.M. Number	
83613	W	141083 (2)	
R	88-96	ISUZU FTR All Models with O.E.M. Number	
85000 Series			
85000	A		
R		THOMAS VARIOUS	
85001	B	401754 (4)	
F	93-05	KENWORTH K300 All Models with Taper Leaf Springs on Front Axle (1" Mounting bolts)	
F		T300	
85003	B		
R	00-05	INTERNATIONAL 4900 All International Corporate Air Suspension	
85005	C		
F	60-68	CHEVROLET 4, 40, 4000 & 4500 SERIES	
F	63-69	5, 50, 5000 & 5500 SERIES	
R	08-23	FORD F-53	
R	20-24	FOREST RIVER GEORGETOWN GT7 All MotorHomes with Ford F53 Chassis with 24,000 lb GVW to 26,000 lb GVW	
F		FREIGHTLINER BUS CHASSIS	
F		VARIOUS	
F	63-66	GMC 3500 & 4000 SERIES	
F	63-68	5000 SERIES	
F	63-68	5500 SERIES	
F	63-68	6000 SERIES	
R	20-23	HOLIDAY RAMBLER INVICTA All MotorHomes with Ford F53 Chassis with 24,000 lb GVW to 26,000 lb GVW	
R	11-23	VACATIONER All MotorHomes with Ford F53 Chassis with 24,000 lb GVW to 26,000 lb GVW	
R	09	VACATIONER All MotorHomes with Ford F53 Chassis with 24,000 lb GVW to 26,000 lb GVW	
R	11-23	THOR MOTOR COACH OUTLAW All MotorHomes with Ford F53 Chassis with 24,000 lb GVW to 26,000 lb GVW	
R	19-23	WINNEBAGO ADVENTURER All MotorHomes with Ford F53 Chassis with 24,000 lb GVW to 26,000 lb GVW	
R	08-17	ADVENTURER All MotorHomes with Ford F53 Chassis with 24,000 lb GVW to 26,000 lb GVW	
R	16-22	SUNSTAR All MotorHomes with Ford F53 Chassis with 24,000 lb GVW to 26,000 lb GVW	
R	08-22	VISTA All MotorHomes with Ford F53 Chassis with 24,000 lb GVW to 26,000 lb GVW	
85006	B		
F	08-23	FORD F-53	
F	24	F-53 MOTORHOME CHASSIS	
F	24	F-59 COMMERCIAL STRIPPED CHASSIS	
F	11-23	F-59 COMMERCIAL STRIPPED CHASSIS All MotorHomes with Ford F59 Commercial Chassis with 24,000 lb GVW to 26,000 lb GVW	
F	20-24	FOREST RIVER GEORGETOWN GT7 All MotorHomes with Ford F53 Chassis with 24,000 lb GVW to 26,000 lb GVW	
F		FREIGHTLINER BUS CHASSIS	
F	97-08	BUS CHASSIS	
F	95-05	FL50 All Models with 10,000 to 18,000 lb Suspension	
F	91-05	FL60 All Models with 10,000 to 18,000 lb Suspension	
F	20-24	HOLIDAY RAMBLER INVICTA All MotorHomes with Ford F53 Chassis with 24,000 lb GVW to 26,000 lb GVW	
F	11-24	VACATIONER All MotorHomes with Ford F53 Chassis with 24,000 lb GVW to 26,000 lb GVW	

83000 Series, 85000 Series

Shock	POP	Alternative No.	MTG Acc. Supplied
Pos.	Year	Application	
85006	B (cont)		
F	09	VACATIONER All MotorHomes with Ford F53 Chassis with 24,000 lb GVW to 26,000 lb GVW	
F		STERLING TRUCK ACTERRA	
R		THOMAS VARIOUS	
R	03	VARIOUS	
F	11-24	THOR MOTOR COACH OUTLAW All MotorHomes with Ford F53 Chassis with 24,000 lb GVW to 26,000 lb GVW	
F	19-24	WINNEBAGO ADVENTURER All MotorHomes with Ford F53 Chassis with 24,000 lb GVW to 26,000 lb GVW	
F	08-17	ADVENTURER All MotorHomes with Ford F53 Chassis with 24,000 lb GVW to 26,000 lb GVW	
F	16-24	SUNSTAR All MotorHomes with Ford F53 Chassis with 24,000 lb GVW to 26,000 lb GVW	
F	08-24	VISTA All MotorHomes with Ford F53 Chassis with 24,000 lb GVW to 26,000 lb GVW	
85007	W	401754 (4)	
F	93-05	KENWORTH K300 All K300 COE Medium Duty	
85009	W	145054 (1)	
F	91-95	MITSUBISHI FUSO FK All FK455 Models with 19mm Lower Mounting Pin, with OEM Number	
F	91-95	FK All FK457 Models with 19mm Lower Mounting Pin, with OEM Number	
F	87-95	FK All FK415 Models with 19mm Lower Mounting Pin, with OEM Number	
F	95	FK All FK190; 19mm Lower Mounting Pin, with OEM Number	
F	88-90	FK All FK455 Models with O.E.M. Number	
F	89-93	FM All FM557 Models with O.E.M. Number	
F	88	FM All FM555 Models with O.E.M. Number	
F	87	FM All FM557 Models with O.E.M. Number	
F	86	FM All FM555 Models with O.E.M. Number	
85010	W		
R	11-20	FORD F-53	
R	11-21	F-59 COMMERCIAL STRIPPED CHASSIS All F59 Commercial Chassis with 16,000 lb or 19,500 GVW	
R	89-97	F-59 COMMERCIAL STRIPPED CHASSIS All F59 Commercial Chassis with 16,000 lb or 19,500 GVW	
F	00-01	HOLIDAY RAMBLER ADMIRAL All Models with Workhorse W22 Chassis with 8.1L Gas V8	
F	00-03	ENDEAVOR All Models with Workhorse W22 Chassis with 8.1L Gas V8	
F	00-03	VACATIONER All Models with Workhorse W22 Chassis with 8.1L Gas V8	
F	00-03	MONACO COACH CLASS A MOTORHOMES	
85012	B	145080 (2)	
F		INTERNATIONAL A, B, AC AND BC CONVENTIONAL	
R		A, B, AC AND BC CONVENTIONAL BINDER	
F		CARGOSTAR	
R	85	ISUZU ADDITIONAL APPLICATIONS	
R	86-95	NPR All	
F	13	PETERBILT 220 All Models with 12,000 lb Front Axle	
F	10	220 All Models with 12,000 lb Front Axle	
F	07	220 All Models with 12,000 lb Front Axle	
F	08-19	325 All Models with 12000 lb Set Back Front Axle	
F	05-10	335 All Models with 12000 lb Set Back Front Axle	

Numerical listing

Shock	POP	Alternative No.	MTG Acc. Supplied
Pos.	Year	Application	
85013	C		
R	00-02	CHEVROLET T6500 All With Hendrickson Air Suspension	
R	00-02	T7500 All With Hendrickson Air Suspension	
F	11-20	FORD F-53	
F	11-21	F-59 COMMERCIAL STRIPPED CHASSIS All F59 Commercial Chassis with 16,000 lb to 22,000 GVW	
F	89-97	F-59 COMMERCIAL STRIPPED CHASSIS All F59 Commercial Chassis with 16,000 lb to 22,000 GVW	
R	00-02	GMC T6500 All With Hendrickson Air Suspension	
R	00-02	T7500 All With Hendrickson Air Suspension	
R	13-22	PETERBILT 220 All Models with Reyco 102AR (Standard) Rear Air Suspension	
R	10	220 All Models with Reyco 102AR (Standard) Rear Air Suspension	
R	07	220 All Models with Reyco 102AR (Standard) Rear Air Suspension	
85014	D		
F		THOMAS VARIOUS	
85029	B		
R	06	COACHMEN CROSS COUNTRY	
R	03-05	CROSS COUNTRY ELITE	
R	03-05	CROSS COUNTRY SE	
R	02-04	FOREST RIVER REFLECTION	
R	02-06	TSUNAMI	
R	03-12	FREIGHTLINER VC CHASSIS	
R	03-12	XC CHASSIS	
R	03-06	GULF STREAM ATRIUM	
R	02-06	FRIENDSHIP	
R	02	INDEPENDENCE All MotorHomes with Freightliner XC Chassis and ADL200 Suspension w/ 20K Rear	
R	02-06	SCENIC CRUISER	
R	02-04	YELLOWSTONE	
R	95-03	HOLIDAY RAMBLER CLASS A MOTORHOMES	
R	02-06	ITASCA CLASS A MOTORHOMES	
R	04-06	KING OF THE ROAD CLASS A MOTORHOMES	
R	04-06	MANDALAY COACH CLASS A MOTORHOMES	
R	95-99	MONACO COACH VARIOUS	
R	02-06	NEWMAR CLASS A MOTORHOMES	
R	02-06	THOR MOTOR COACH CLASS A MOTORHOMES	
R	02-06	WINNEBAGO JOURNEY All MotorHomes with Freightliner XC Chassis and ADL200 Suspension w/ 20K Rear	
R	06	TOUR All MotorHomes with Freightliner XC Chassis and ADL200 Suspension w/ 20K Rear	
R	06	VECTRA All MotorHomes with Freightliner XC Chassis and ADL200 Suspension w/ 20K Rear	
85031	D	145147(1)/TR0027(2)	
F	93-05	KENWORTH K300 All Models with 12,000 lb Taper Leaf Front Springs (5/8" Top Mounting bolt)	
F	08-21	T170 All Models with 8,000 lb Taper Leaf Front Springs	
F	08-10	T270 All Models with 12,000 lb Front Axle	
F	99-08	T300 All Models with 12,000 lb Taper Leaf Front Springs (5/8" Top Mounting bolt)	
85036	D		
R		XOS ADDITIONAL O.E.M. INTERCHANGES	
85043	W		
F		FREIGHTLINER BUS CHASSIS	
F	95-05	FL50 All Models with 6000 to 9000 lb Front axle	
F	91-05	FL60 All Models with 6000 to 9000 lb Front axle	
F	00-02	XCS CHASSIS	
85058	C		
F		FREIGHTLINER MB CHASSIS	
F	98-23	MT45 All Step Van Models with O.E.M. Number	
F		MT55	

Numerical listing

Shock	POP	Alternative No.	MTG Acc. Supplied
Pos.	Year	Application	
85058		C (cont)	
F		VARIOUS	
F	00-05	INTERNATIONAL 4700	All With OEM Number
F	00-05	4900	All With OEM Number
F		THOMAS	VARIOUS
85069		A	145089-000 (2)
R	24	KENWORTH T270	
R	20-23	T270	All Models with Air Glide 400L (AG400L) Rear Air Suspension
R	08-23	T270	All Models with AG210L Rear Air Suspension
R	05-10	PETERBILT 335	All Models with Peterbilt Low Air Leaf Suspension
R	22-24	536	All Models with Peterbilt Low Air Leaf Suspension
85071		W	145054 (2)
R	90-96	CHEVROLET C60 KODIAK	All Conventional Cab w/15000, 19000, 21000 lb Multileaf Springs
R	90-02	C4500 KODIAK	
R	03-09	C4500 KODIAK	All C Chassis - Conventional Cab With 15000, 19000, 21000 lb Multileaf Springs
R	92-02	C5500 KODIAK	
R	03-09	C5500 KODIAK	All C Chassis - Conventional Cab With 15000, 19000, 21000 lb Multileaf Springs
R	90-91	C5500 KODIAK	All C Chassis - Conventional Cab With 15000, 19000, 21000 lb Multileaf Springs
R	97-09	C6500 KODIAK	All Conventional Cab w/15000, 19000, 21000 lb Multileaf Springs
R	00-01	C7500 KODIAK	All Conventional Cab w/15000, 19000, 21000 lb Multileaf Springs
R	90-06	T5500	
R	03	T6500	
R	90-96	T6500	
R	04-05	T6500	All Tilt Cab w/15000, 19000, 21000 lb Multileaf Springs
R	97-02	T6500	All Tilt Cab w/15000, 19000, 21000 lb Multileaf Springs
R	04-05	T7500	All Tilt Cab w/15000, 19000, 21000 lb Multileaf Springs
R	97-02	T7500	All Tilt Cab w/15000, 19000, 21000 lb Multileaf Springs
R	04-05	T8500	All Tilt Cab w/15000, 19000, 21000 lb Multileaf Springs
R	90-02	GMC C4500 TOPKICK	
R	03-09	C4500 TOPKICK	All C Chassis - Conventional Cab with 15000, 19000, 21000 lb Multileaf Springs
R	90-02	C5500 TOPKICK	
R	03-09	C5500 TOPKICK	All C Chassis - Conventional Cab with 15000, 19000, 21000 lb Multileaf Springs
R	90-09	C - SERIES (C6500, C7500, C8500)	TOPKICK
R	90-06	T5500	
R	03	T6500	
R	90-96	T6500	
R	04-05	T6500	All Tilt Cab with 15000, 19000, 21000 lb Multileaf Springs
R	97-02	T6500	All Tilt Cab with 15000, 19000, 21000 lb Multileaf Springs
R	04-05	T7500	All Tilt Cab with 15000, 19000, 21000 lb Multileaf Springs
R	97-02	T7500	All Tilt Cab with 15000, 19000, 21000 lb Multileaf Springs
F	18-20	ISUZU FTR	All FTR Diesel Models with Std Cab
R	90-09	FTR	All Models with 15000, 19000, 21000 lb Multileaf Springs
R	05-08	HVR	All Conventional Cab W/15000, 19000, 21000lb Multi Leaf Springs
85072		C	
R	08-22	KENWORTH T270	All Models with Hendrickson Primaax 230, 232, 460, 462, 690 and 692 Air Suspension (8-1/2" to 10" Ride Height)
R	19-23	PIERCE MFG. INC.	VARIOUS
85084		C	
F	10-14	KENWORTH T270	All Models with 10,000 lb to 12,000 lb Front Axle
F	10-14	T270	All Models with 13,200 lb to 14,600 lb Front Axle
F	10-14	T270	All Models with 8,000 lb Front Axle

85000 Series

Shock	POP	Alternative No.	MTG Acc. Supplied
Pos.	Year	Application	
85084		C (cont)	
F	08-15	PETERBILT 325	All Models with 8,000 lb Front Axle
85106		W	
F	21-22	LION LION6	All Trucks with Hendrickson Softek Suspension (12,500 lb Capacity)
85124		W	145054 (2)
R	04-11	DAMON CLASS A	MOTORHOMES
R	04-11	FLEETWOOD CLASS A	MOTORHOMES
R	04-11	HOLIDAY RAMBLER CLASS A	MOTORHOMES
R	04-11	ITASCA CLASS A	MOTORHOMES
R	04-08	NATIONAL RV CLASS A	MOTORHOMES
R	04-09	WINNEBAGO ADVENTURER	All Models with Workhorse W22, & W24 MotorHome Chassis with O.E.M. Number
R	04-09	WORKHORSE W20	All Models with O.E.M. Number
R	04-09	W22	All Models with O.E.M. Number
R	04-09	W24	All Models with O.E.M. Number
85125		W	
F	98-11	DAMON CLASS A	MOTORHOMES
F	98-11	HOLIDAY RAMBLER CLASS A	MOTORHOMES
F	98-11	ITASCA CLASS A	MOTORHOMES
F	98-11	MONACO COACH CLASS A	MOTORHOMES
F	98-08	NATIONAL RV CLASS A	MOTORHOMES
F	98-11	WINNEBAGO ADVENTURER	All Models with W20 & W22 Workhorse Motorhome Chassis
F	01-09	WORKHORSE W20	All
F	01-09	W22	All
F	04-09	W24	All MotorHome Chassis with O.E.M. Number
85180		W	
R	21-24	FORD F-650	All Models with 13,500, 15,500 & 19,000 lb Multi-leaf Rear Springs
R	15-19	F-650	All Models with 13,500, 15,500 & 19,000 lb Multi-leaf Rear Springs
R	15-23	GLAVAL BUS CO. CONCORDE II - SERIES	
85181		W	
F	21-24	FORD F-650	All Models with 19.5" or 22.5" Wheels (22,000 lb GVW)
F	15-19	F-650	All Models with 19.5" or 22.5" Wheels (22,000 lb GVW)
F	15-23	GLAVAL BUS CO. CONCORDE II - SERIES	
85182		W	145089-200 (2)
F	13-24	KENWORTH K270	All Models with 10,000 lb to 12,000 lb Front Axle
F	13-24	PETERBILT 220	All Models with 12,000 lb Front Axle
85188		D	
R	23	MACK MD6	
R	24	MD6	All Models with O.E.M. Number
R	21-22	MD6	All Models with O.E.M. Number
85300		D	401754 (4)
R		INTERNATIONAL CARGOSTAR	
85304		W	401754 (4)
F		THOMAS	VARIOUS
85307		W	401754 (4)
F	60-68	GMC 5500 SERIES	
F	60-68	6000 SERIES	
R		THOMAS	VARIOUS
85310		B	141108 (1)
R	93-05	KENWORTH K300	All All with Air Glide 100 Suspension with 8 air bags, 4 units required
R		T300	
85311		A	141247 (1)
R	05-10	PETERBILT 335	All Models with Air Trac Suspension (46,000 lb)

Numerical listing

Shock	POP	Alternative No.	MTG Acc. Supplied
Pos.	Year	Application	
85316		D	145090 (1)
F	00-05	INTERNATIONAL 4900	All With Dual Doors
85329		W	401754 (4)
F		EMERGENCY ONE	VARIOUS
85331		C	
R	05-15	FREIGHTLINER M2	All Models with Freightliner Low Profile Rear Air Suspension (18,000 to 40,000 lb)
R	02-10	M2 100	All Models with Freightliner Low Profile Rear Air Suspension (18,000 to 40,000 lb)
R	02-15	M2 106	All Models with Freightliner Low Profile Rear Air Suspension (18,000 to 40,000 lb)
R		MB CHASSIS	
R	99-24	MT55	All Models with Freightliner Low Profile Rear Air Suspension
85332		W	145128 (1)
R	00-02	CHEVROLET T6500	All with 16,900lb Axle. Tapered Leaf Springs
R	00-02	T7500	All with 16,900lb Axle. Tapered Leaf Springs
R	00-02	GMC T6500	All with 16,900lb Axle. Tapered Leaf Springs
R	00-02	T7500	All with 16,900lb Axle. Tapered Leaf Springs
85335		W	
R	05-21	FREIGHTLINER M2	All Models with Rear 10000 lb - 15000 lb Low Profile AirLiner
R	02-10	M2 100	All Models with Rear 10000 lb - 15000 lb Low Profile AirLiner
R	02-23	M2 106	All Models with Rear 10000 lb - 15000 lb Low Profile AirLiner
85642		A	
R	19-22	INTERNATIONAL MV607	All Models with International 21,000 lb Rear Air Suspension
85649		W	143146 (1)
F	12-18	RAM 4500	All Models with O.E.M. Number
F	12-18	5500	All Models with O.E.M. Number
F	08-10	STERLING TRUCK BULLET 45	All Models with O.E.M. Number
F	08-10	BULLET 55	All Models with O.E.M. Number
85650		W	
R	12-18	RAM 4500	All Models with O.E.M. Number
R	12-18	5500	All Models with O.E.M. Number
R	08-10	STERLING TRUCK BULLET 45	All Models with O.E.M. Number
R	08-10	BULLET 55	All Models with O.E.M. Number
85656		C	
R	14	FORD F-650	
R	15	F-650	All Models with 21,000 lb Rear Air Suspension
R	04-13	F-650	All Models with 21,000 lb Rear Air Suspension
R	04-15	GLAVAL BUS CO. CONCORDE II - SERIES	
R	16-19	INTERNATIONAL DURASTAR	All Models with 20,000 lb International IROS Air Suspension
R		DURASTAR - 4300, 4400 SERIES	
R	16-19	DURASTAR - 4300, 4400 SERIES	
R	25	MV60E	All with IROS 20k Rear
R	20-22	MV607	All Models with 20,000 lb International IROS Air Suspension
R	20	MV	All Models with 20,000 lb International IROS Air Suspension
R	20-22	PIERCE MFG. INC.	VARIOUS
85670		W	
R	25	CHEVROLET SILVERADO 4500HD	
R	19-24	SILVERADO 4500 HD	All Models with IROS Rear
R	25	SILVERADO 5500HD	
R	19-24	SILVERADO 5500 HD	All Models with IROS Rear
R	25	SILVERADO 6500HD	
R	19-24	SILVERADO 6500 HD	All Models with IROS Rear

Numerical listing

Shock	POP	Alternative No.	MTG Acc. Supplied
Pos.	Year	Application	
85670	W	(cont)	
R	19-23	INTERNATIONAL CV515 All Models with IROS Rear	
85705	W	145090 (2)	
R	06-09	CHEVROLET T6500 All 15,000lb;17,000lb; 19,000lb; 21,000lb and 23,000lb Axle	
R	06-09	T7500 All 15,000lb;17,000lb; 19,000lb; 21,000lb and 23,000lb Axle	
R	06-09	T8500 All 15,000lb;17,000lb; 19,000lb; 21,000lb and 23,000lb Axle	
R	06-09	GMC T6500 All 15,000lb;17,000lb; 19,000lb; 21,000lb and 23,000lb Axle	
R	06-09	T7500 All 15,000lb;17,000lb; 19,000lb; 21,000lb and 23,000lb Axle	
85711	W	145054(1)/401754(2)	
R	88-01	MITSUBISHI FUSO FP SERIES	
85716	W	145093 (1)	
R	90-94	FORD F-600 LPO All Models with O.E.M. Number	
85724	A		
R	02-19	FEDERAL COACH VARIOUS	
R	05-23	FREIGHTLINER B2 All Models with FAS II (40,000 lb) Rear Air Suspension	
R	95-05	FL50 All Models with FAS II (40,000 lb) Rear Air Suspension	
R	91-05	FL60 All Models with FAS II (40,000 lb) Rear Air Suspension	
R	05-21	M2 All Models with FAS II (40,000 lb) Rear Air Suspension	
R	02-10	M2 100 All Models with FAS II (40,000 lb) Rear Air Suspension	
R	02-25	M2 106 All Models with FAS II (40,000 lb) Rear Air Suspension	
R	18-24	VARIOUS	
R	18-24	JAYCO SENECA All Models with Freightliner S2RV chassis	
R	21-23	SENECA PRESTIGE All Models with Freightliner S2RV chassis	
R	18-24	RENEGADE VALENCIA All Models with Freightliner S2RV chassis	
R	03-10	STERLING TRUCK ACTERRA All Models with FAS II (40,000 lb) Rear Air Suspension	
R	01-07	ACTERRA 5500 All Models with FAS II (40,000 lb) Rear Air Suspension	
R	01-07	ACTERRA 6500 All Models with FAS II (40,000 lb) Rear Air Suspension	
R		THOMAS VARIOUS	
R	22-24	THOR MOTOR COACH INCEPTION All Models with Freightliner S2RV chassis	
R	22-24	PASADENA All Models with Freightliner S2RV chassis	
85734	W	401754 (4)	
R		INTERNATIONAL CARGOSTAR	
85736	W	401754 (4)	
F		THOMAS VARIOUS	
85900	B	145054 (2)	
F	06	COACHMEN CROSS COUNTRY	
F	03-05	CROSS COUNTRY ELITE	
F	03-05	CROSS COUNTRY SE	
F	02-04	FOREST RIVER REFLECTION	
F	02-06	TSUNAMI	
F	03-07	FREIGHTLINER VC CHASSIS	
F		XC CHASSIS	
F	03-07	XC CHASSIS	
F	03-06	GULF STREAM ATRIUM	
F	02-06	FRIENDSHIP	
F	02	INDEPENDENCE All Models with Freightliner XC Chassis with ZF - IFS Front Suspension and 23,000 lb GVW or Greater	
F	02-06	SCENIC CRUISER	
F	02-04	YELLOWSTONE	
F	02-06	ITASCA CLASS A MOTORHOMES	
R	93-05	KENWORTH K300 All All with Air Glide 200 with 40,000 lb Suspension with 8 air bags, 4 units required	
R		T300	
F	04-06	KING OF THE ROAD CLASS A MOTORHOMES	

85000 Series

Shock	POP	Alternative No.	MTG Acc. Supplied
Pos.	Year	Application	
85900	B	(cont)	
F	04-06	MANDALAY COACH CLASS A MOTORHOMES	
F	02-06	NEWMAR CLASS A MOTORHOMES	
F	02-06	THOR MOTOR COACH CLASS A MOTORHOMES	
85902	W	145054 (2)	
R	93-05	KENWORTH K300 All All with Air Glide 200 with 46,000 lb Suspension with 8 air bags, 4 units required	
R	95-08	T300 All All with Air Glide 200 with 46,000 lb Suspension with 8 air bags, 4 units required	
85909	D		
R		NEWMAR CLASS A MOTORHOMES	
85910	W		
R		FREIGHTLINER VARIOUS	
F		PETERBILT 330	
85918	A		
F	05-23	FREIGHTLINER B2 All Models with 12000 lb Taperleaf Front Suspension	
F	18-24	VARIOUS	
F	18-24	JAYCO SENECA All Models with Freightliner S2RV chassis	
F	21-24	SENECA PRESTIGE All Models with Freightliner S2RV chassis	
F	18-24	RENEGADE VALENCIA All Models with Freightliner S2RV chassis	
F	22-24	THOR MOTOR COACH INCEPTION All Models with Freightliner S2RV chassis	
F	22-24	PASADENA All Models with Freightliner S2RV chassis	
85919	A		
R		FREIGHTLINER MB CHASSIS	
F	99-24	MT55 All MT55 Chassis with O.E.M. Number	
R		WORKHORSE VARIOUS	
85920	B		
F	02-08	FEDERAL COACH VARIOUS	
F	02-08	FREIGHTLINER M2 106 All Models with 10000 to 12000 lb. Taper-leaf Spring Suspension	
F	02-08	M2 106 All Models with 6000 to 9000 lb Front axle	
F	01-09	STERLING TRUCK ACTERRA	
85921	W	145054 (1)	
R	05-21	FREIGHTLINER M2 All Models with Rear 60" Spring ,18000 lb - 23000 lb	
R	02-10	M2 100 All Models with Rear 60" Spring ,18000 lb - 23000 lb	
R	02-23	M2 106 All Models with Rear 60" Spring ,18000 lb - 23000 lb	
85923	D		
R	08-09	INTERNATIONAL 4300 All Models with International 40,000 lb Rear Air Suspension	
R	08-09	4400 All Models with International 40,000 lb Rear Air Suspension	
R		DURASTAR - 4300, 4400 SERIES	
R	10-11	DURASTAR - 4300, 4400 SERIES	
85927	W		
R	14	FORD F-650	
R	15	F-650 All Models with International Air Suspension (4x2)	
R	04-13	F-650 All Models with International Air Suspension (4x2)	
R	02-10	INTERNATIONAL 4200 All with Tapered Rail, 5.6" Ride Height, W/IAS Suspension	
R		DURASTAR - 4300, 4400 SERIES	
85928	C		
F	14	FORD F-650	
F	15	F-650 All Models with 12,000 & 13,200 lb Front Springs	
F	00-13	F-650 All Models with 12,000 & 13,200 lb Front Springs	
F	00-15	GLAVAL BUS CO. CONCORDE II - SERIES	
F	02-10	INTERNATIONAL 4200 All With 10,000lb - 14,000lb Axle	
F	16-20	DURASTAR All Models with 11,000 lb to 14,000 lb Front axle	

Numerical listing

Shock	POP	Alternative No.	MTG Acc. Supplied
Pos.	Year	Application	
85928	C	(cont)	
F	16-20	DURASTAR - 4300, 4400 SERIES	
F	23	EMV607	
F	25	MV60E All Models with 11,000 lb to 14,000 lb Taper Leaf Springs	
F	19-22	MV607 All Models with 11,000 lb to 14,000 lb Taper-leaf Springs	
F	19-23	PIERCE MFG. INC. VARIOUS	
85932	C		
F	03-10	STERLING TRUCK ACTERRA All Models with Hendrickson Front Airtek	
F	01-07	ACTERRA 5500 All Models with Hendrickson Front Airtek	
F	01-07	ACTERRA 6500 All Models with Hendrickson Front Airtek	
85956	C		
R	05-21	FREIGHTLINER M2 All Models with Freightliner TuffTrac Rear Air Suspension	
R	02-10	M2 100 All Models with Freightliner TuffTrac Rear Air Suspension	
R	02-25	M2 106 All Models with Freightliner TuffTrac Rear Air Suspension	
R	03-10	STERLING TRUCK ACTERRA All All Models with Freightliner TuffTrac Rear Air Suspension	
85957	D		
F	02-10	INTERNATIONAL 4200 All with 6,000lb - 8,000lb Axle	
F	02-15	4300 All Models with 12,000 lb Front axle	
F	02-15	4400 All Models with 12,000 lb Front axle	
F	12-18	8600 TRANSTAR All Models with 10,000 to 14,000 lb Front Axle	
F	15	DURASTAR All Models with 12,000 lb Front axle	
F	13	DURASTAR All Models with 12,000 lb Front axle	
F	10-15	DURASTAR - 4300, 4400 SERIES	
F	19-21	PIERCE MFG. INC. VARIOUS	
85958	A		
F	09-24	PIERCE MFG. INC. VARIOUS	
85959	A		
F	19-21	DYNAMAX CORP FORCE HD	
F	09-19	FEDERAL COACH VARIOUS	
F		FREIGHTLINER M2	
F	09-25	M2 106 All Models with 8000 to 16000 lb Front Axle and Taperleaf Spring	
F	09-24	PIERCE MFG. INC. VARIOUS	
F		XOS ADDITIONAL O.E.M. INTERCHANGES	
85976	D		
R	14	FORD F-650	
R	15	F-650 All Models with Hendrickson HAS - 230 Rear Air Suspension	
R	04-13	F-650 All Models with Hendrickson HAS - 230 Rear Air Suspension	
R	02-20	INTERNATIONAL 4300 All Models with Hendrickson HAS - 230 or 460 Rear Air Suspension	
R	02-20	4400 All Models with Hendrickson HAS - 230 or 460 Rear Air Suspension	
R	00-14	5500I All Hendrickson HAS-402 Air Ride Suspension	
R	15-20	DURASTAR All Models with Hendrickson HAS - 230 or 460 Rear Air Suspension	
R	13	DURASTAR All Models with Hendrickson HAS - 230 or 460 Rear Air Suspension	
R	19-22	MV607 All Models with Hendrickson HAS - 230 or 460 Rear Air Suspension	
R	20	MV All Models with Hendrickson HAS - 230 or 460 Rear Air Suspension	
R	19-22	PIERCE MFG. INC. VARIOUS	
85978	B		
R	21-24	FORD F-650 All Models with Hendrickson HAS - 400/460 Rear Air Suspension	
R	15-19	F-650 All Models with Hendrickson HAS - 400/460 Rear Air Suspension	

Numerical listing

Shock	POP	Alternative No.	MTG Acc. Supplied
Pos.	Year	Application	
85979	W		
R	00-14	INTERNATIONAL	5500I All Hendrickson HAS-402 Air Ride Suspension
85988	D	145099 (1)	
R	22-24	PETERBILT	536 All Models with Air Trac Suspension (40,000 lb)
85989	A		
F	15-22	KENWORTH	T270 All Models with 10,000 lb to 14,600 lb Taperleaf Springs and Set Back Front Axles
F	15-22		T270 All Models with 16,000 lb to 20,000 lb Taperleaf Springs and Set Back Front Axles
F	24		T280 All Models with 10,000 lb to 12,000 lb Mono-leaf front springs
F	22-24	PETERBILT	536 All Models with 10,000 lb to 14,600 lb Taperleaf Springs and Set Back Front Axles
85995	W		
F	19-21	PIERCE MFG. INC.	VARIOUS
89000 Series			
89405	W		
R	00-03	FORD	F-650 All Models with Hendrickson HAS - 190 Rear Air Suspension
R	13-24	KENWORTH	K270 All Models with Hendrickson HAS - 210L or HAS - 230L Rear Air Suspension
R	93-05	K300	All Models with Hendrickson Rear Air Suspension
R	08-23	T270	All Models with Hendrickson HAS - 210L or HAS - 230L Rear Air Suspension
R		T300	
R	95-08	T300	All Models with Hendrickson HAS - 210L or HAS - 230L Rear Air Suspension
R	13-24	PETERBILT	220 All Models with Hendrickson HAS - 210L or HAS - 230L Rear Air Suspension
R	10	220	All Models with Hendrickson HAS - 210L or HAS - 230L Rear Air Suspension
R	07	220	All Models with Hendrickson HAS - 210L or HAS - 230L Rear Air Suspension
R		XOS	ADDITIONAL O.E.M. INTERCHANGES
89406	W		
R	97-09	CHEVROLET	C6500 KODIAK All Models with Hendrickson Air Suspension (Stamping number 47902-13)
R	00-01	C7500 KODIAK	All Models with Hendrickson Air Suspension (Stamping number 47902-13)
R	99	T6500	All Models with Hendrickson Air Suspension (Stamping number 47902-13)
R	99	T7500	All Models with Hendrickson Air Suspension (Stamping number 47902-13)
R	04-09	T8500	All Models with Hendrickson Air Suspension (Stamping number 47902-13)
R	09	COACHMEN	AURORA
R	07	AURORA	
R	08	AURORA	All MotorHomes with Ford F53 Chassis with 16,000 lb GVW to 22,000 lb GVW
R	04-06	AURORA	All MotorHomes with Ford F53 Chassis with 16,000 lb GVW to 22,000 lb GVW
R	21-24	ENCORE	All MotorHomes with Ford F53 Chassis with 16,000 lb GVW to 22,000 lb GVW
R	11-16	ENCOUNTER	All MotorHomes with Ford F53 Chassis with 16,000 lb GVW to 22,000 lb GVW
R	99-07	MIRADA	
R	08-24	MIRADA	All MotorHomes with Ford F53 Chassis with 16,000 lb GVW to 22,000 lb GVW
R	04-12	PURSUIT	
R	13-24	PURSUIT	All MotorHomes with Ford F53 Chassis with 16,000 lb GVW to 22,000 lb GVW
R	12-13	DAMON	DAYBREAK
R	99	DAYBREAK	

85000 Series, 89000 Series

Shock	POP	Alternative No.	MTG Acc. Supplied
Pos.	Year	Application	
89406	W (cont)		
R	99	INTRUDER	
R	12-14	OUTLAW	
R	19-20	FLEETWOOD	AXON
R	06-23	FORD	F-53
R	99-04	F-53	
R	13-24	FOREST RIVER	FR3 All MotorHomes with Ford F53 Chassis with 16,000 lb GVW to 22,000 lb GVW
R	08-17	GEORGETOWN	All MotorHomes with Ford F53 Chassis with 16,000 lb GVW to 22,000 lb GVW
R	16-24	GEORGETOWN	GT3 All MotorHomes with Ford F53 Chassis with 16,000 lb GVW to 22,000 lb GVW
R	17-24	GEORGETOWN	GT5 All MotorHomes with Ford F53 Chassis with 16,000 lb GVW to 22,000 lb GVW
R	20-24	GEORGETOWN	GT7 All MotorHomes with Ford F53 Chassis with 16,000 lb GVW to 22,000 lb GVW
R	99-09	GEORGIE BOY MANUFACTURING	CLASS A MOTORHOMES
R	95-02	GMC	C - SERIES (C6500, C7500, C8500) TOPKICK
R	99	T5500	
R	99	T6500	All Models with Hendrickson Air Suspension (Stamping number 47902-13)
R	99	T7500	All Models with Hendrickson Air Suspension (Stamping number 47902-13)
R	11-15	HOLIDAY RAMBLER	ADMIRAL
R	02-06	ADMIRAL	
R	16-24	ADMIRAL	All MotorHomes with Ford F53 Chassis with 16,000 lb GVW to 22,000 lb GVW
R	07-10	ADMIRAL	All MotorHomes with Ford F53 Chassis with 16,000 lb GVW to 22,000 lb GVW
R	00-01	ADMIRAL	All MotorHomes with Ford F53 Chassis with 16,000 lb GVW to 22,000 lb GVW
R	02-06	ADMIRAL	SE All MotorHomes with Ford F53 Chassis with 16,000 lb GVW to 22,000 lb GVW
R	07	ADMIRAL	SVE All MotorHomes with Ford F53 Chassis with 16,000 lb GVW to 22,000 lb GVW
R	16-18	ADMIRAL	XE All MotorHomes with Ford F53 Chassis with 16,000 lb GVW to 22,000 lb GVW
R	23-24	ECLIPSE	All MotorHomes with Ford F53 Chassis with 16,000 lb GVW to 22,000 lb GVW
R	15	ENDEAVOR	
R	16-24	ENDEAVOR	All MotorHomes with Ford F53 Chassis with 16,000 lb GVW to 22,000 lb GVW
R	00-14	ENDEAVOR	All MotorHomes with Ford F53 Chassis with 16,000 lb GVW to 22,000 lb GVW
R	11-24	VACATIONER	All MotorHomes with Ford F53 Chassis with 16,000 lb GVW to 22,000 lb GVW
R	09	VACATIONER	All MotorHomes with Ford F53 Chassis with 16,000 lb GVW to 22,000 lb GVW
R	00-07	VACATIONER	All MotorHomes with Ford F53 Chassis with 16,000 lb GVW to 22,000 lb GVW
R		ISUZU	FVR
R	99-15	ITASCA	CLASS A MOTORHOMES
R	16-24	JAYCO	ALANTE All MotorHomes with Ford F53 Chassis with 16,000 lb GVW to 22,000 lb GVW
R	14-20	CLASS A	MOTORHOMES
R	14-24	PRECEPT	All MotorHomes with Ford F53 Chassis with 16,000 lb GVW to 22,000 lb GVW
R	99-08	NATIONAL RV	CLASS A MOTORHOMES
R	13-20	NEWMAR	CLASS A MOTORHOMES
R	16-20	NEXUS	CLASS A MOTORHOMES
R	17-20	MAYBACH	All MotorHomes with Ford F53 Chassis with 16,000 lb GVW to 22,000 lb GVW

Numerical listing

Shock	POP	Alternative No.	MTG Acc. Supplied
Pos.	Year	Application	
89406	W (cont)		
R	11-24	THOR MOTOR COACH	A.C.E. All MotorHomes with Ford F53 Chassis with 16,000 lb GVW to 22,000 lb GVW
R	05-08	CHALLENGER	
R	09-24	CHALLENGER	All MotorHomes with Ford F53 Chassis with 16,000 lb GVW to 22,000 lb GVW
R	04-10	HURRICANE	
R	11-24	HURRICANE	All MotorHomes with Ford F53 Chassis with 16,000 lb GVW to 22,000 lb GVW
R	23-24	INDIGO	All MotorHomes with Ford F53 Chassis with 16,000 lb GVW to 22,000 lb GVW
R	23-24	LUMINATE	All MotorHomes with Ford F53 Chassis with 16,000 lb GVW to 22,000 lb GVW
R	14-24	MIRAMAR	All MotorHomes with Ford F53 Chassis with 16,000 lb GVW to 22,000 lb GVW
R	07-10	OUTLAW	
R	11-23	OUTLAW	All MotorHomes with Ford F53 Chassis with 16,000 lb GVW to 22,000 lb GVW
R	23-24	RESONATE	All MotorHomes with Ford F53 Chassis with 16,000 lb GVW to 22,000 lb GVW
R	06-10	WINDSPORT	
R	11-24	WINDSPORT	All MotorHomes with Ford F53 Chassis with 16,000 lb GVW to 22,000 lb GVW
R	19-23	WINNEBAGO	ADVENTURER All Motorhomes with Ford F-53 Chassis with 16,000 lb GVW to 22,000 lb GVW
R	06-17	ADVENTURER	All Motorhomes with Ford F-53 Chassis with 16,000 lb GVW to 22,000 lb GVW
R	99-04	ADVENTURER	All Motorhomes with Ford F-53 Chassis with 16,000 lb GVW to 22,000 lb GVW
R	18-20	INTENT	All Motorhome Chassis with 16,000 lb GVW to 18,000 lb GVW
R	18-20	INTENT	All Motorhome Chassis with 20,500 lb GVW to 22,000 lb GVW
R	11-17	SIGHTSEER	All Motorhome Chassis with 16,000 lb GVW to 18,000 lb GVW
R	11-17	SIGHTSEER	All Motorhome Chassis with 20,500 lb GVW to 22,000 lb GVW
R	08-09	SIGHTSEER	All Motorhome Chassis with 16,000 lb GVW to 18,000 lb GVW
R	06-09	SIGHTSEER	All Motorhome Chassis with 20,500 lb GVW to 22,000 lb GVW
R	02-04	SIGHTSEER	All Motorhome Chassis with 20,500 lb GVW to 22,000 lb GVW
R	16-17	SUNOVA	All Motorhome Chassis with 16,000 lb GVW to 18,000 lb GVW
R	16-17	SUNOVA	All Motorhome Chassis with 20,500 lb GVW to 22,000 lb GVW
R	06-07	SUNOVA	All Motorhome Chassis with 20,500 lb GVW to 22,000 lb GVW
R	02-04	SUNOVA	All Motorhome Chassis with 20,500 lb GVW to 22,000 lb GVW
R	16-22	SUNSTAR	All Motorhome Chassis with 16,000 lb GVW to 18,000 lb GVW
R	16-22	SUNSTAR	All Motorhome Chassis with 20,500 lb GVW to 22,000 lb GVW
R	02-04	SUNSTAR	All Motorhome Chassis with 20,500 lb GVW to 22,000 lb GVW
R	16-18	SUNSTAR	LX All Motorhome Chassis with 16,000 lb GVW to 18,000 lb GVW
R	16-18	SUNSTAR	LX All Motorhome Chassis with 20,500 lb GVW to 22,000 lb GVW
R	11-22	VISTA	All Motorhome Chassis with 16,000 lb GVW to 18,000 lb GVW
R	11-22	VISTA	All Motorhome Chassis with 20,500 lb GVW to 22,000 lb GVW

Numerical listing

Shock	POP	Alternative No.	MTG Acc. Supplied
Pos.	Year	Application	
89406 W (cont)			
R	08-09	VISTA All Motorhome Chassis with 16,000 lb GVW to 18,000 lb GVW	
R	07-09	VISTA All Motorhome Chassis with 20,500 lb GVW to 22,000 lb GVW	
R	02-04	VISTA All Motorhome Chassis with 20,500 lb GVW to 22,000 lb GVW	
R	16-18	VISTA LX All Motorhome Chassis with 16,000 lb GVW to 18,000 lb GVW	
R	16-18	VISTA LX All Motorhome Chassis with 20,500 lb GVW to 22,000 lb GVW	
89407 W			
F	73-80	CHEVROLET 5, 50, 5000 & 5500 SERIES	
F		COACHMEN CLASS A MOTORHOMES	
F		FOREST RIVER CLASS A MOTORHOMES	
F		GEORGIE BOY MANUFACTURING CLASS A MOTORHOMES	
F	73-80	GMC 5000 SERIES	
F	73-75	6000 SERIES	
F	73-75	6500 SERIES	
F		ITASCA CLASS A MOTORHOMES	
F		MONACO COACH CLASS A MOTORHOMES	
F		WORKHORSE VARIOUS	
89409 W 140149 (1)			
F	80-86	FORD C600 All Models with 4040, 5040 lb Springs and 7000, 9000, 12000 lb Axles	
F	80-85	LN600 All Models with 4400 lb Spring and 7000, 9000 lb Axles	
F	93-05	KENWORTH K300 All Models with Multiple Leaf Springs on Front Axle (3/4" Mounting bolts)	
F		T300	
89410 C 401754 (4)			
F	93-05	KENWORTH K300 All Models with Taper Leaf Springs on Front Axle (1" Mounting bolts)	
F		T300	
89413 W 145080 (2)			
F		INTERNATIONAL A, B, AC AND BC CONVENTIONAL	
R		A, B, AC AND BC CONVENTIONAL BINDER	
F		CARGOSTAR	
R	85	ISUZU ADDITIONAL APPLICATIONS	
R	86-95	NPR All	
F	13	PETERBILT 220 All Models with 12,000 lb Front Axle	
F	10	220 All Models with 12,000 lb Front Axle	
F	07	220 All Models with 12,000 lb Front Axle	
F	08-19	325 All Models with 12000 lb Set Back Front Axle	
F	05-10	335 All Models with 12000 lb Set Back Front Axle	
89414 W			
F	09	COACHMEN AURORA	
F	07	AURORA	
F	08	AURORA All MotorHomes with Ford F53 Chassis with 16,000 lb GVW to 22,000 lb GVW	
F	04-06	AURORA All MotorHomes with Ford F53 Chassis with 16,000 lb GVW to 22,000 lb GVW	
F	21-24	ENCORE All MotorHomes with Ford F53 Chassis with 16,000 lb GVW to 22,000 lb GVW	
F	11-16	ENCOUNTER All MotorHomes with Ford F53 Chassis with 16,000 lb GVW to 22,000 lb GVW	
F	99-07	MIRADA	
F	08-24	MIRADA All MotorHomes with Ford F53 Chassis with 16,000 lb GVW to 22,000 lb GVW	
F	04-12	PURSUIT	
F	13-24	PURSUIT All MotorHomes with Ford F53 Chassis with 16,000 lb GVW to 22,000 lb GVW	
F	12-13	DAMON DAYBREAK	
F	99	DAYBREAK	
F	99	INTRUDER	
F	12-14	OUTLAW	
F	19-20	FLEETWOOD AXON	

89000 Series

Shock	POP	Alternative No.	MTG Acc. Supplied
Pos.	Year	Application	
89414 W (cont)			
F	06-23	FORD F-53	
F	99-04	F-53	
F	88-97	F-53	
F	05	F-53 MOTORHOME CHASSIS	
F	98	F-53 MOTORHOME CHASSIS	
F	11-21	F-59 COMMERCIAL STRIPPED CHASSIS All F59 Commercial Chassis with 16,000 lb to 22,000 GVW	
F	89-97	F-59 COMMERCIAL STRIPPED CHASSIS All F59 Commercial Chassis with 16,000 lb to 22,000 GVW	
F	13-24	FOREST RIVER FR3 All MotorHomes with Ford F53 Chassis with 16,000 lb GVW to 22,000 lb GVW	
F	08-17	GEORGETOWN All MotorHomes with Ford F53 Chassis with 16,000 lb GVW to 22,000 lb GVW	
F	16-24	GEORGETOWN GT3 All MotorHomes with Ford F53 Chassis with 16,000 lb GVW to 22,000 lb GVW	
F	17-24	GEORGETOWN GT5 All MotorHomes with Ford F53 Chassis with 16,000 lb GVW to 22,000 lb GVW	
F	20-24	GEORGETOWN GT7 All MotorHomes with Ford F53 Chassis with 16,000 lb GVW to 22,000 lb GVW	
F	99-09	GEORGIE BOY MANUFACTURING CLASS A MOTORHOMES	
F	11-15	HOLIDAY RAMBLER ADMIRAL	
F	02-06	ADMIRAL	
F	16-24	ADMIRAL All MotorHomes with Ford F53 Chassis with 16,000 lb GVW to 22,000 lb GVW	
F	07-10	ADMIRAL All MotorHomes with Ford F53 Chassis with 16,000 lb GVW to 22,000 lb GVW	
F	00-01	ADMIRAL All MotorHomes with Ford F53 Chassis with 16,000 lb GVW to 22,000 lb GVW	
F	02-06	ADMIRAL SE All MotorHomes with Ford F53 Chassis with 16,000 lb GVW to 22,000 lb GVW	
F	07	ADMIRAL SVE All MotorHomes with Ford F53 Chassis with 16,000 lb GVW to 22,000 lb GVW	
F	16-18	ADMIRAL XE All MotorHomes with Ford F53 Chassis with 16,000 lb GVW to 22,000 lb GVW	
F	23-24	ECLIPSE All MotorHomes with Ford F53 Chassis with 16,000 lb GVW to 22,000 lb GVW	
F	15	ENDEAVOR	
F	16-24	ENDEAVOR All MotorHomes with Ford F53 Chassis with 16,000 lb GVW to 22,000 lb GVW	
F	00-14	ENDEAVOR All MotorHomes with Ford F53 Chassis with 16,000 lb GVW to 22,000 lb GVW	
F	11-24	VACATIONER All MotorHomes with Ford F53 Chassis with 16,000 lb GVW to 22,000 lb GVW	
F	09	VACATIONER All MotorHomes with Ford F53 Chassis with 16,000 lb GVW to 22,000 lb GVW	
F	00-07	VACATIONER All MotorHomes with Ford F53 Chassis with 16,000 lb GVW to 22,000 lb GVW	
F	99-15	ITASCA CLASS A MOTORHOMES	
F	16-24	JAYCO ALANTE All MotorHomes with Ford F53 Chassis with 16,000 lb GVW to 22,000 lb GVW	
F	14-20	CLASS A MOTORHOMES	
F	14-24	PRECEPT All MotorHomes with Ford F53 Chassis with 16,000 lb GVW to 22,000 lb GVW	
F	07-08	MONACO COACH LA PALMA	
F	01	LA PALMA	
F	90-99	LA PALMA	
F	03-05	MONARCH	
F	90-99	MONARCH	
F	99-08	NATIONAL RV CLASS A MOTORHOMES	
F	13-20	NEWMAR CLASS A MOTORHOMES	
F	16-20	NEXUS CLASS A MOTORHOMES	
F	17-20	MAYBACH All MotorHomes with Ford F53 Chassis with 16,000 lb GVW to 22,000 lb GVW	

Numerical listing

Shock	POP	Alternative No.	MTG Acc. Supplied
Pos.	Year	Application	
89414 W (cont)			
R	13-22	PETERBILT 220 All Models with Reyco 102AR (Standard) Rear Air Suspension	
R	10	220 All Models with Reyco 102AR (Standard) Rear Air Suspension	
R	07	220 All Models with Reyco 102AR (Standard) Rear Air Suspension	
F	11-24	THOR MOTOR COACH A.C.E. All MotorHomes with Ford F53 Chassis with 16,000 lb GVW to 22,000 lb GVW	
F	05-08	CHALLENGER	
F	09-24	CHALLENGER All MotorHomes with Ford F53 Chassis with 16,000 lb GVW to 22,000 lb GVW	
F	04-10	HURRICANE	
F	11-24	HURRICANE All MotorHomes with Ford F53 Chassis with 16,000 lb GVW to 22,000 lb GVW	
F	23-24	INDIGO All MotorHomes with Ford F53 Chassis with 16,000 lb GVW to 22,000 lb GVW	
F	23-24	LUMINATE All MotorHomes with Ford F53 Chassis with 16,000 lb GVW to 22,000 lb GVW	
F	14-24	MIRAMAR All MotorHomes with Ford F53 Chassis with 16,000 lb GVW to 22,000 lb GVW	
F	07-10	OUTLAW	
F	11-23	OUTLAW All MotorHomes with Ford F53 Chassis with 16,000 lb GVW to 22,000 lb GVW	
F	23-24	RESONATE All MotorHomes with Ford F53 Chassis with 16,000 lb GVW to 22,000 lb GVW	
F	06-10	WINDSPORT	
F	11-24	WINDSPORT All MotorHomes with Ford F53 Chassis with 16,000 lb GVW to 22,000 lb GVW	
F	19-23	WINNEBAGO ADVENTURER All MotorHomes with Ford F53 Chassis with 16,000 lb GVW to 22,000 lb GVW	
F	92-17	ADVENTURER All MotorHomes with Ford F53 Chassis with 16,000 lb GVW to 22,000 lb GVW	
F	18-20	INTENT All MotorHomes with Ford F53 Chassis with 16,000 lb GVW to 22,000 lb GVW	
F	02-17	SIGHTSEER All MotorHomes with Ford F53 Chassis with 16,000 lb GVW to 22,000 lb GVW	
F	16-17	SUNOVA All MotorHomes with Ford F53 Chassis with 16,000 lb GVW to 22,000 lb GVW	
F	02-07	SUNOVA All MotorHomes with Ford F53 Chassis with 16,000 lb GVW to 22,000 lb GVW	
F	16-22	SUNSTAR All MotorHomes with Ford F53 Chassis with 16,000 lb GVW to 22,000 lb GVW	
F	02-04	SUNSTAR All MotorHomes with Ford F53 Chassis with 16,000 lb GVW to 22,000 lb GVW	
F	16-18	SUNSTAR LX All MotorHomes with Ford F53 Chassis with 16,000 lb GVW to 22,000 lb GVW	
F	07-22	VISTA All MotorHomes with Ford F53 Chassis with 16,000 lb GVW to 22,000 lb GVW	
F	02-04	VISTA All MotorHomes with Ford F53 Chassis with 16,000 lb GVW to 22,000 lb GVW	
F	16-18	VISTA LX All MotorHomes with Ford F53 Chassis with 16,000 lb GVW to 22,000 lb GVW	
89419 W 401754 (4)			
R		INTERNATIONAL CARGOSTAR	
89423 W 141108 (1)			
R	93-05	KENWORTH K300 All All with Air Glide 100 Suspension with 8 air bags, 4 units required	
R		T300	
89424 B 141247 (1)			
R	05-10	PETERBILT 335 All Models with Air Trac Suspension (46,000 lb)	
89425 W 401754 (4)			
R	00-14	INTERNATIONAL 5500I All Chalmers 854-46	

Numerical listing

89000 Series, Steering Stabilizer, Ultra ReadyMount

Numerical listing

Shock	POP	Alternative No.	MTG Acc. Supplied
Pos.	Year	Application	
89430 C			
F	60-70	CHEVROLET 4, 40, 4000 & 4500 SERIES	
R	71-72	5, 50, 5000 & 5500 SERIES	
F	63-70	5, 50, 5000 & 5500 SERIES	
R	08-23	FORD F-53	
R	20-24	FOREST RIVER GEORGETOWN GT7 All MotorHomes with Ford F53 Chassis with 24,000 lb GVW to 26,000 lb GVW	
F		FREIGHTLINER BUS CHASSIS	
R	02-23	M2 106 All Models with Reyco 79KB Rear Steel Spring Suspension VARIOUS	
F	63-66	GMC 3500 & 4000 SERIES	
F	72-80	4500 SERIES	
R	66-72	4500 SERIES	
F	63-68	5000 SERIES	
F	63-89	5500 SERIES	
R	66-72	5500 SERIES	
F	79-80	6000 SERIES	
F	63-68	6000 SERIES	
F	66-80	6500 SERIES	
R	66-80	6500 SERIES	
F	05-10	HINO 145 All Models with O.E.M. Number	
F	05-10	165 All Models with O.E.M. Number	
F	05-10	185 All Models with O.E.M. Number	
R	20-23	HOLIDAY RAMBLER INVICTA All MotorHomes with Ford F53 Chassis with 24,000 lb GVW to 26,000 lb GVW	
R	11-23	VACATIONER All MotorHomes with Ford F53 Chassis with 24,000 lb GVW to 26,000 lb GVW	
R	09	VACATIONER All MotorHomes with Ford F53 Chassis with 24,000 lb GVW to 26,000 lb GVW	
R	13-24	KENWORTH K270 All Models with Reyco 102 or 79KB Suspension (Drive Axle)	
R	93-05	K300 All Models with Reyco 102 or 79KB Suspension (Drive Axle)	
F	93-05	K300 All Models with Reyco 1209 or 1212 Suspension (Steer Axle)	
R	08-22	T170 All Models with Reyco 79KB Rear Steel Spring Suspension	
R	08-23	T270 All Models with Reyco 102 or 79KB Suspension (Drive Axle)	
R	21-24	T280 All Models with Reyco 102 or 79KB Suspension (Drive Axle)	
F		T300	
R	99-08	T300 All Models with Reyco 102 or 79KB Suspension (Drive Axle)	
R	99-08	T300 All Models with Reyco 1209 or 1212 Suspension (Steer Axle)	
R	08-15	PETERBILT 210 All Models with Reyco 102 or 79KB Suspension (Drive Axle)	
R	13-24	220 All Models with Reyco 102 or 79KB Suspension (Drive Axle)	
R	10	220 All Models with Reyco 102 or 79KB Suspension (Drive Axle)	
R	07	220 All Models with Reyco 102 or 79KB Suspension (Drive Axle)	
R	08-19	325 All Models with Reyco 102 or 79KB Suspension (Drive Axle)	
R	11-24	THOR MOTOR COACH OUTLAW All MotorHomes with Ford F53 Chassis with 24,000 lb GVW to 26,000 lb GVW	
R	19-23	WINNEBAGO ADVENTURER All MotorHomes with Ford F53 Chassis with 24,000 lb GVW to 26,000 lb GVW	
R	08-17	ADVENTURER All MotorHomes with Ford F53 Chassis with 24,000 lb GVW to 26,000 lb GVW	
R	16-22	SUNSTAR All MotorHomes with Ford F53 Chassis with 24,000 lb GVW to 26,000 lb GVW	
R	08-22	VISTA All MotorHomes with Ford F53 Chassis with 24,000 lb GVW to 26,000 lb GVW	

Shock	POP	Alternative No.	MTG Acc. Supplied
Pos.	Year	Application	
89431 W			
F		FREIGHTLINER MB CHASSIS	
F	98-23	MT45 All Step Van Models with O.E.M. Number	
F		MT55	
F		VARIOUS	
F		THOMAS VARIOUS	

Shock	POP	Alternative No.	MTG Acc. Supplied
Pos.	Year	Application	
89436 B			
R		THOMAS VARIOUS	
89443 C			
R	02-19	FEDERAL COACH VARIOUS	
R	05-23	FREIGHTLINER B2 All Models with FAS II (40,000 lb) Rear Air Suspension	
R	95-05	FL50 All Models with FAS II (40,000 lb) Rear Air Suspension	
R	91-05	FL60 All Models with FAS II (40,000 lb) Rear Air Suspension	
R	05-21	M2 All Models with FAS II (40,000 lb) Rear Air Suspension	
R	02-10	M2 100 All Models with FAS II (40,000 lb) Rear Air Suspension	
R	02-24	M2 106 All Models with FAS II (40,000 lb) Rear Air Suspension	
R	18-24	VARIOUS	
R	18-24	JAYCO SENECA All Models with Freightliner S2RV chassis	
R	21-23	SENECA PRESTIGE All Models with Freightliner S2RV chassis	
R	18-24	RENEGADE VALENCIA All Models with Freightliner S2RV chassis	
R	03-10	STERLING TRUCK ACTERRA All Models with FAS II (40,000 lb) Rear Air Suspension	
R	01-07	ACTERRA 5500 All Models with FAS II (40,000 lb) Rear Air Suspension	
R	01-07	ACTERRA 6500 All Models with FAS II (40,000 lb) Rear Air Suspension	
R		THOMAS VARIOUS	
R	22-24	THOR MOTOR COACH INCEPTION All Models with Freightliner S2RV chassis	
R	22-24	PASADENA All Models with Freightliner S2RV chassis	
89447 W 141108 (1)			
F		INTERNATIONAL SERIES 4000 - SHORT CONVENTIONAL MEDIUM TRK & TRAC	
F	90-02	SERIES 4000 - SHORT CONVENTIONAL MEDIUM TRK & TRAC	
F	86-88	MITSUBISHI FUSO FM All Model with O.E.M. Number	
89449 D			
F	05-23	FREIGHTLINER B2 All Models with 12000 lb Taperleaf Front Suspension	
F	18-24	VARIOUS	
F	18-24	JAYCO SENECA All Models with Freightliner S2RV chassis	
F	21-24	SENECA PRESTIGE All Models with Freightliner S2RV chassis	
F	18-24	RENEGADE VALENCIA All Models with Freightliner S2RV chassis	
F	22-24	THOR MOTOR COACH INCEPTION All Models with Freightliner S2RV chassis	
F	22-24	PASADENA All Models with Freightliner S2RV chassis	
89453 W			
F	03-10	STERLING TRUCK ACTERRA All Models with Hendrickson Front Airtek	
F	01-07	ACTERRA 5500 All Models with Hendrickson Front Airtek	
F	01-07	ACTERRA 6500 All Models with Hendrickson Front Airtek	
89455 C 141108 (1)			
R	08-23	KENWORTH T270 All Models with AG210L Rear Air Suspension	
R	05-10	PETERBILT 335 All Models with Peterbilt Low Air Leaf Suspension	
R	22-24	536 All Models with Peterbilt Low Air Leaf Suspension	
89458 W			
R	08-09	INTERNATIONAL 4300 All Models with International 40,000 lb Rear Air Suspension	
R	08-09	4400 All Models with International 40,000 lb Rear Air Suspension	
R	08-11	8500 TRANSTAR All Models with International 40,000lb Rear Air Suspension	
R	08-18	8600 TRANSTAR All Models with International 40,000lb Rear Air Suspension	

Shock	POP	Alternative No.	MTG Acc. Supplied
Pos.	Year	Application	
89458 W (cont)			
R		DURASTAR - 4300, 4400 SERIES	
R	10-11	DURASTAR - 4300, 4400 SERIES	
R		TERRASTAR	
89460 W			
F	10-14	KENWORTH T270 All Models with 10,000 lb to 12,000 lb Front Axle	
F	10-14	T270 All Models with 13,200 lb to 14,600 lb Front Axle	
F	10-14	T270 All Models with 8,000 lb Front Axle	
F	08-15	PETERBILT 325 All Models with 8,000 lb Front Axle	
89503 W			
F	02-08	FEDERAL COACH VARIOUS	
F	02-08	FREIGHTLINER M2 106 All Models with 10000 to 12000 lb. Taper-leaf Spring Suspension	
F	02-08	M2 106 All Models with 6000 to 9000 lb Front axle	
F	01-09	STERLING TRUCK ACTERRA	
Steering Stabilizer			
6802SE A 141998			
F	90-92	FORD F-SUPER DUTY All Single System Steering Stabilizer All models with factory frame bracket. Kit 143168 required to install to linkage.	
F	68-72	INTERNATIONAL M1100 / M1200 All Single System Steering Stabilizer; 1/2 and 3/4 Ton I-Beam Axle All models with factory frame bracket. Kit 143168 required to install to linkage.	
F	69	M1400 All Single System Steering Stabilizer; 1/2 and 3/4 Ton I-Beam Axle All models with factory frame bracket. Kit 143168 required to install to linkage.	
6828SE D 142718			
F	00-02	FORD E-450 ECONOLINE SUPER DUTY All Single System Steering Stabilizer	
F	02	E-550 ECONOLINE SUPER DUTY All Single System Steering Stabilizer	
F	03	E-550 SUPER DUTY All Single System Steering Stabilizer	
F	21-24	VAN 1 TON, ECONOLINE / CLUB WAGON / SUPERDUTY All Single System Steering Stabilizer	
F	03-19	VAN 1 TON, ECONOLINE / CLUB WAGON / SUPERDUTY All Single System Steering Stabilizer	
6854SE D 142718			
F	99-04	FORD PICKUP, F-450 SUPERDUTY 4 X 4 Single System Steering Stabilizer	
F	99-04	PICKUP, F-550 SUPERDUTY 4 X 4 Single System Steering Stabilizer	
Ultra ReadyMount			
G57800 B			
F	25	COACHMEN NOVA 20C Left	
F	26	RAM PROMASTER 3500	
F	25	THOR MOTOR COACH DAZZLE 2JB Left	
F	24	SCOPE 18M Left	
G57801 B			
F	25	COACHMEN NOVA 20C Right	
F	26	RAM PROMASTER 3500	
F	25	THOR MOTOR COACH DAZZLE 2JB Right	
F	24	SCOPE 18M Right	
G57816 C			
F	19-22	COACH HOUSE PLATINUM III All MotorHomes with Ford Transit-350 Chassis	
F	19-22	COACHMEN BEYOND All MotorHomes with Ford Transit-350 Chassis	
F	21-22	CROSS TRAIL TRANSIT All MotorHomes with Ford Transit-350 Chassis	
F	17-22	FOREST RIVER FORESTER TS All MotorHomes with Ford Transit-350 Chassis	
F	17-22	SUNSEEKER TS All MotorHomes with Ford Transit-350 Chassis	

Numerical listing

Shock	POP	Alternative No.	MTG Acc. Supplied
Pos.	Year	Application	
G57816	C (cont)		
F	19-22	LEISURE TRAVEL WONDER All MotorHomes with Ford Transit-350 Chassis	
F	20-22	PHOENIX TRX All MotorHomes with Ford Transit-350 Chassis	
F	19-22	THOR MOTOR COACH GEMINI All MotorHomes with Ford Transit-350 Chassis	
F	21-22	WINNEBAGO EKKO All MotorHomes with Ford Transit-350 Chassis	
Ultra Truck Shock			
G63183	D		
R	63-81	CHRYSLER MOTORHOME CHASSIS	
R	73-78	DODGE TRUCK D SERIES- CONVENTIONAL CAB 4 X 2	
R	64-72	LN & LNT - CONVENTIONAL CAB	
R	64-73	LNT, LVT, NLT, VLT- TILT CAB 6 X 4	
R	73-75	LS & LT-STEEL TILT CAB	
R	63-81	MOTORHOME CHASSIS	
R	63-82	P SERIES - FORWARD CONTROL	
R	61-78	SCHOOL BUSES	
R	61-78	W-SERIES AND POWER WAGONS	
F	73	W-SERIES AND POWER WAGONS	
R		HOLIDAY RAMBLER VARIOUS	
G63299	A		140885
R	00-01	MITSUBISHI CANTER 35	
R	00-05	55	
R	01-05	60	
R	01-05	75	
R	01-19	FB SERIES	
R	93-99	FB SERIES	
R	84-20	FE SERIES	
R	05-13	MITSUBISHI FUSO FE	
R	85-86	FE	
R	01-04	FE All FE7 & FE8 Series; Model with O.E.M. Number	
R	87-04	FE All Model with O.E.M. Number	
R	89-97	FE All FE335EV Series; Model with O.E.M. Number	
R	92-93	FE All FE337EV Series; Model with O.E.M. Number	
R	87-89	FE All FE435 Series; Model with O.E.M. Number	
R	80-01	FP SERIES	
G63306	C		
F	64-67	FORD C & CT SERIES - TILT CAB	
F		INTERNATIONAL A, B, AC AND BC CONVENTIONAL	
R	66-75	METRO & MULTI-SHOP SERIES	
G63366	A		
R		WORKHORSE VARIOUS	
G63405	A		140884
R	68-72	INTERNATIONAL M1100 / M1200 All	
R	69	M1400 All	
R	05	MITSUBISHI ROSA	
R	97-99	ROSA	
F	04-13	MITSUBISHI CANTER FE SERIES	
F	84-95	FE SERIES	
R	96-04	MITSUBISHI FUSO FE All Model with O.E.M. Number	
F	96-99	FE All With OEM Number	
F	06	FE SERIES	
R	98-04	FG All Model with O.E.M. Number	
F	00-02	FG All With OEM Number	
R	91	FG FG434 With OEM Number	
R	89-97	FG SERIES	
R	14-21	MITSUBISHI FUSO BUS BE637	
G63409	C		
R	88-97	FORD F-SUPER DUTY All	
R	97	PICKUP, F-450 SUPERDUTY All	
G63419	W		
R	98	HINO FA, FB SERIES	
G63432	A		141349,140169
F		INTERNATIONAL DURASTAR - 1000 SERIES	
F		UD UD 1300	
G63461	A		
R	99-07	FORD PICKUP, F-450 SUPERDUTY All Models with single or dual rear wheels with 165" or 201" wheel base	

Ultra ReadyMount, Ultra Truck Shock

Shock	POP	Alternative No.	MTG Acc. Supplied
Pos.	Year	Application	
G63461	A (cont)		
R	99-07	PICKUP, F-550 SUPERDUTY All Models with single or dual rear wheels with 165" or 201" wheel base	
G63605	C		140169
F	73-81	DODGE TRUCK MOTORHOME CHASSIS	
G63610	A		142389
F	89-91	HINO FA14 All Models with O.E.M. Number	
F	92	FA15 All FA, FB Models Trucks with:	
F	93-97	FA1415 All (FA15)	
F	93-97	FA1415 All FA, FB Models Trucks with:	
F	93-97	FA1415 All FA1415 (FA15), FB1715 (FB15)	
F	98-04	FA1517 All FA, FB Models Trucks with:	
F	89-91	FB14 All FA, FB Models Trucks with:	
F	92	FB15 All FA, FB Models Trucks with:	
F	93-97	FB1715 All FA, FB Models Trucks with:	
F	93-97	FB1715 All FA1415 (FA15), FB1715 (FB15)	
F	98-04	FB1817 All FA, FB Models Trucks with:	
F	05-11	MITSUBISHI FUSO FE145 All Models with O.E.M. Number	
F	96-04	FE All Models with O.E.M. Number	
F	88-04	FH All Models with O.E.M. Number	
F	99-10	UD UD 18HD SERIES	
F	11-13	UD 1800 SERIES	
F	95-98	UD 1800 SERIES	
F	95-13	UD 2000 SERIES	
G63622	A		142617
F	17-24	BERKSHIRE COACH ULTRA 24	
F	17-24	ULTRA 28	
F	92-24	BLUE BIRD MICROBIRD TYPE A SCHOOL BUS	
F		CHAMPION BUS INC. AMERICAN COACH	
F		CHALLENGER	
F		CRUSADER	
F		LF TRANSPORT	
F	03-24	COACH HOUSE PLATINUM All Motorhomes with Ford E450 Chassis	
F	23-24	PLATINUM IV All Motorhomes with Ford E450 Chassis	
F		COACHMEN CATALINA	
F	20-22	CONCORD	
F	04-06	CONCORD	
F	23-24	CONCORD All MotorHomes with Ford E350 or E450 Chassis	
F	07-19	CONCORD All MotorHomes with Ford E350 or E450 Chassis	
F	04-08	FREEDOM EXPRESS	
F	09	FREEDOM EXPRESS All MotorHomes with Ford E350 or E450 Chassis	
F	03-07	FREELANDER	
F	08-24	FREELANDER All MotorHomes with Ford E350 or E450 Chassis	
F	10	LEPRECHAUN	
F	03-07	LEPRECHAUN	
F	11-24	LEPRECHAUN All MotorHomes with Ford E350 or E450 Chassis	
F	08-09	LEPRECHAUN All MotorHomes with Ford E350 or E450 Chassis	
F	98-03	PATHFINDER	
F	99-06	SANTARA	
F		COLLINS BUS CORP. VARIOUS	
F		DIAMOND COACH SHUTTLE BUSES	
F	92-09	DUTCHMEN RV CLASS C MOTORHOMES	
F	15-20	JAMBOREE	
F	92-17	DYNAMAX CORP ISATA 4	
F	18-20	ISATA 4 All MotorHomes with Ford E350 or E450 Chassis	
F		ELDORADO NATIONAL	
F		ADVANTAGE	
F		AEROLITE	
F		AEROTECH	
F	17	ENTEGRA COACH ESTEEM	
F	18-24	ESTEEM All MotorHomes with Ford E350 or E450 Chassis	
F	17	ODYSSEY	
F	26	ODYSSEY 24B With Ford E-450 Super Duty Medium Duty	

Numerical listing

Shock	POP	Alternative No.	MTG Acc. Supplied
Pos.	Year	Application	
G63622	A (cont)		142617
F	26	ODYSSEY 30Z With Ford E-450 Super Duty	
F	18-24	ODYSSEY All MotorHomes with Ford E350 or E450 Chassis	
F	23-24	ODYSSEY SE All MotorHomes with Ford E450 Chassis	
F		FEDERAL COACH VARIOUS	
F	20	FLEETWOOD JAMBOREE	
F	14-16	JAMBOREE	
F	99-07	JAMBOREE	
F	17-19	JAMBOREE All MotorHomes with Ford E350 or E450 Chassis	
F	08-13	JAMBOREE All MotorHomes with Ford E350 or E450 Chassis	
F	19-20	SURGE	
F	18	SURGE All MotorHomes with Ford E350 or E450 Chassis	
F	14-16	TIOGA	
F	99-07	TIOGA	
F	08-13	TIOGA All MotorHomes with Ford E350 or E450 Chassis	
F	00-02	FORD E-450 ECONOLINE SUPER DUTY All	
F	20-24	F-600 SUPER DUTY All Applications with OEM Number	
F	21-26	VAN 1 TON, ECONOLINE / CLUB WAGON / SUPERDUTY All	
F	03-19	VAN 1 TON, ECONOLINE / CLUB WAGON / SUPERDUTY All	
F		FOREST RIVER ALL AMERICAN	
F	20	FORESTER	
F	04-19	FORESTER All MotorHomes with Ford E350 or E450 Chassis	
F	15-18	FORESTER GTS All MotorHomes with Ford E350 or E450 Chassis	
F	03-15	LEXINGTON All MotorHomes with Ford E350 or E450 Chassis	
F	21-24	SOLERA All MotorHomes with Ford E350 or E450 Chassis	
F	10-15	SOLERA All MotorHomes with Ford E350 or E450 Chassis	
F	23	SUNSEEKER	
F	99-06	SUNSEEKER	
F	07-22	SUNSEEKER All MotorHomes with Ford E350 or E450 Chassis	
F	19-20	SUNSEEKER GTS	
F	15-18	SUNSEEKER GTS All MotorHomes with Ford E350 or E450 Chassis	
F	99-09	GEORGIE BOY MANUFACTURING CLASS C MOTORHOMES	
F		GLAVAL BUS CO. VARIOUS	
F		GOSHEN COACH VARIOUS	
F		GRECH MOTORS VARIOUS	
F	02-15	GULF STREAM BT CRUISER	
F	16-24	BT CRUISER All MotorHomes with Ford E350 or E450 Chassis	
F	99-06	CAVALIER	
F	12-15	CONQUEST	
F	93-01	CONQUEST	
F	16-24	CONQUEST All MotorHomes with Ford E350 or E450 Chassis	
F	02-11	CONQUEST All MotorHomes with Ford E350 or E450 Chassis	
F	10-11	CONQUEST SPORT All MotorHomes with Ford E350 or E450 Chassis	
F	01-02	CONQUEST SPORT All MotorHomes with Ford E350 or E450 Chassis	
F	00-11	INDEPENDENCE All MotorHomes with Ford E350 or E450 Chassis	
F	10-11	MONTAJ All MotorHomes with Ford E350 or E450 Chassis	
F	00-08	ULTRA	
F	02-04	YELLOWSTONE	
F	05-11	YELLOWSTONE All MotorHomes with Ford E350 or E450 Chassis	
F	19	HOLIDAY RAMBLER ALTERA	
F	18	ALTERA All MotorHomes with Ford E450 Chassis	
F	08	ATLANTIS	
F	06	ATLANTIS	
F	99-01	ATLANTIS	
F	09-10	ATLANTIS All MotorHomes with Ford E450 Chassis	
F	07	ATLANTIS All MotorHomes with Ford E450 Chassis	
F	02-05	ATLANTIS All MotorHomes with Ford E450 Chassis	
F	19	AUGUSTA All MotorHomes with Ford E450 Chassis	
F	15-16	AUGUSTA All MotorHomes with Ford E450 Chassis	

Numerical listing

Shock	POP	Alternative No.	MTG Acc. Supplied
Pos.	Year	Application	
G63622	A (cont)		142617
F 11	08-09	AUGUSTA All MotorHomes with Ford E450 Chassis	
F 12-13	08-09	AUGUSTA B+ All MotorHomes with Ford E450 Chassis	
F 10	08-09	AUGUSTA B+ All MotorHomes with Ford E450 Chassis	
F 07	08-09	AUGUSTA B+ All MotorHomes with Ford E450 Chassis	
F 16	08-09	AUGUSTA LX All MotorHomes with Ford E450 Chassis	
F 07-10	08-09	AUGUSTA SPORT All MotorHomes with Ford E350 Chassis	
F 07-09	08-09	AUGUSTA TOURING SEDAN All MotorHomes with Ford E350 Chassis	
F 17-18	08-09	VESTA All MotorHomes with Ford E450 Chassis	
F 01-20	08-09	ITASCA CLASS C MOTORHOMES	
F 03-06	08-09	JAYCO ESCAPADE All MotorHomes with Ford E350 or E450 Chassis	
F 02-06	08-09	GRANITE RIDGE All MotorHomes with Ford E350 or E450 Chassis	
F 26	08-09	GREYHAWK 29MV With Ford E-450 Super Duty	
F 02-24	08-09	GREYHAWK All MotorHomes with Ford E450 Chassis	
F 07-24	08-09	MELBOURNE All MotorHomes with Ford E350 or E450 Chassis	
F 13-24	08-09	REDHAWK All MotorHomes with Ford E450 Chassis	
F 25	08-09	REDHAWK 30Z	
F 26	08-09	REDHAWK 31FF	
F 26	08-09	REDHAWK SE All With Ford E-350 Super Duty	
F 18-24	08-09	REDHAWK SE All MotorHomes with Ford E450 Chassis	
F	08-09	KRYSTAL BUS VARIOUS	
F	08-09	LGE COACHWORKS VARIOUS	
F 11-12	08-09	NEXUS CLASS C MOTORHOMES	
F 11-24	08-09	PHANTOM All MotorHomes with Ford E350 or E450 Chassis	
F 20-24	08-09	TRIUMPH All MotorHomes with Ford E350 or E450 Chassis	
F 11-24	08-09	VIPER All MotorHomes with Ford E350 or E450 Chassis	
F 24	08-09	VIPER 29V MotorHomes with Ford E350 or E450 Chassis	
F 00-23	08-09	PHOENIX CRUISER All MotorHomes with Ford E350 or E450 Chassis	
F	08-09	SHASTA RV ALL MODELS	
F	08-09	STARCRAFT BUS CO. E350 & E450 FORD CHASSIS MODELS	
F 92-22	08-09	THOMAS TYPE A SCHOOL BUS	
F 26	08-09	THOR MOTOR COACH AXIS 26.2 With Ford E-450 Super Duty	
F 14-24	08-09	AXIS All MotorHomes with Ford E350 or E450 Chassis	
F 11-24	08-09	CHATEAU All MotorHomes with Ford E350 or E450 Chassis	
F 11-12	08-09	CHATEAU CITATION All MotorHomes with Ford E350 or E450 Chassis	
F 12-16	08-09	CITATION All MotorHomes with Ford E350 or E450 Chassis	
F 22-24	08-09	ECHELON All MotorHomes with Ford E350 or E450 Chassis	
F 11-24	08-09	FOUR WINDS All MotorHomes with Ford E350 or E450 Chassis	
F 25	08-09	FOUR WINDS 282	
F 12-24	08-09	FREEDOM ELITE All MotorHomes with Ford E350 or E450 Chassis	
F 11-23	08-09	OUTLAW All MotorHomes with Ford E350 or E450 Chassis	
F 26	08-09	PASADENA All SE19 Submodel; With Ford E-350 Super Duty	
F 16-24	08-09	QUANTUM All MotorHomes with Ford E350 or E450 Chassis	
F 25	08-09	VEGAS 24.1	
F 14-24	08-09	VEGAS All MotorHomes with Ford E350 or E450 Chassis	
F	08-09	TURTLETOP BUS VARIOUS	
F	08-09	WHEELED COACH IND. VARIOUS	
F 07-13	08-09	WINNEBAGO ACCESS All MotorHomes with Ford E350 or E450 Chassis	
F 14	08-09	ACCESS PREMIER All MotorHomes with Ford E350 or E450 Chassis	
F 18-20	08-09	ASPECT	

Ultra Truck Shock

Shock	POP	Alternative No.	MTG Acc. Supplied
Pos.	Year	Application	
G63622	A (cont)		142617
F 05-17	08-09	ASPECT All MotorHomes with Ford E350 or E450 Chassis	
F 18-20	08-09	CAMBRIA	
F 09-15	08-09	CAMBRIA	
F 16-17	08-09	CAMBRIA All MotorHomes with Ford E350 or E450 Chassis	
F 05-08	08-09	CAMBRIA All MotorHomes with Ford E350 or E450 Chassis	
F 06-20	08-09	MINNIE	
F 99	08-09	MINNIE	
F 00-05	08-09	MINNIE All MotorHomes with Ford E350 or E450 Chassis	
F 14-24	08-09	MINNIE WINNIE All MotorHomes with Ford E350 or E450 Chassis	
F 00-06	08-09	MINNIE WINNIE All MotorHomes with Ford E350 or E450 Chassis	
F 11-18	08-09	OUTLOOK	
F 19-21	08-09	OUTLOOK All MotorHomes with Ford E350 or E450 Chassis	
F 06-10	08-09	OUTLOOK All MotorHomes with Ford E350 or E450 Chassis	
F 08-15	08-09	SPIRIT	
F 16-22	08-09	SPIRIT All MotorHomes with Ford E350 or E450 Chassis	
F 00-07	08-09	SPIRIT All MotorHomes with Ford E350 or E450 Chassis	
F	08-09	WORLD TRANS BUS CO. VARIOUS	
G63623	A		142617
R 17-24	08-09	BERKSHIRE COACH ULTRA 24	
R 17-24	08-09	ULTRA 28	
R 92-24	08-09	BLUE BIRD MICROBIRD TYPE A SCHOOL BUS	
R	08-09	CHAMPION BUS INC. AMERICAN COACH	
R	08-09	CHALLENGER	
R	08-09	CRUSADER	
R	08-09	LF TRANSPORT	
R 03-24	08-09	COACH HOUSE PLATINUM All Motorhomes with Ford E450 Chassis	
R 23-24	08-09	PLATINUM IV All Motorhomes with Ford E450 Chassis	
R	08-09	COACHMEN CATALINA	
R 20-22	08-09	CONCORD	
R 04-06	08-09	CONCORD	
R 23-24	08-09	CONCORD All MotorHomes with Ford E350 or E450 Chassis	
R 07-19	08-09	CONCORD All MotorHomes with Ford E350 or E450 Chassis	
R 04-08	08-09	FREEDOM EXPRESS	
R 09	08-09	FREEDOM EXPRESS All MotorHomes with Ford E350 or E450 Chassis	
R 03-07	08-09	FREELANDER	
R 08-24	08-09	FREELANDER All MotorHomes with Ford E350 or E450 Chassis	
R 10	08-09	LEPRECHAUN	
R 03-07	08-09	LEPRECHAUN	
R 11-24	08-09	LEPRECHAUN All MotorHomes with Ford E350 or E450 Chassis	
R 08-09	08-09	LEPRECHAUN All MotorHomes with Ford E350 or E450 Chassis	
R 98-03	08-09	PATHFINDER	
R 99-06	08-09	SANTARA	
R	08-09	COLLINS BUS CORP. VARIOUS	
R	08-09	DIAMOND COACH SHUTTLE BUSES	
R 92-09	08-09	DUTCHMEN RV CLASS C MOTORHOMES	
R 15-20	08-09	JAMBOREE	
R 92-17	08-09	DYNAMAX CORP ISATA 4	
R 18-20	08-09	ISATA 4 All MotorHomes with Ford E350 or E450 Chassis	
R	08-09	ELDORADO NATIONAL ADVANTAGE	
R	08-09	AEROLITE	
R	08-09	AEROTECH	
R 17	08-09	ENTEGR COACH ESTEEM	
R 18-24	08-09	ESTEEM All MotorHomes with Ford E350 or E450 Chassis	
R 17	08-09	ODYSSEY	
R 26	08-09	ODYSSEY 24B With Ford E-450 Super Duty	
R 26	08-09	ODYSSEY 30Z With Ford E-450 Super Duty	
R 18-24	08-09	ODYSSEY All MotorHomes with Ford E350 or E450 Chassis	
R 23-24	08-09	ODYSSEY SE All MotorHomes with Ford E450 Chassis	
R	08-09	FEDERAL COACH VARIOUS	
R 20	08-09	FLEETWOOD JAMBOREE	
R 14-16	08-09	JAMBOREE	
R 99-07	08-09	JAMBOREE	

Numerical listing

Shock	POP	Alternative No.	MTG Acc. Supplied
Pos.	Year	Application	
G63623	A (cont)		142617
R 17-19	08-09	JAMBOREE All MotorHomes with Ford E350 or E450 Chassis	
R 08-13	08-09	JAMBOREE All MotorHomes with Ford E350 or E450 Chassis	
R 19-20	08-09	SURGE	
R 18	08-09	SURGE All MotorHomes with Ford E350 or E450 Chassis	
R 14-16	08-09	TIOGA	
R 99-07	08-09	TIOGA	
R 08-13	08-09	TIOGA All MotorHomes with Ford E350 or E450 Chassis	
R 00-02	08-09	FORD E-450 ECONOLINE SUPER DUTY AII	
R 21-26	08-09	VAN 1 TON, ECONOLINE / CLUB WAGON / SUPERDUTY AII	
R 03-19	08-09	VAN 1 TON, ECONOLINE / CLUB WAGON / SUPERDUTY AII	
R	08-09	FOREST RIVER ALL AMERICAN	
R 20	08-09	FORESTER	
R 04-19	08-09	FORESTER All MotorHomes with Ford E350 or E450 Chassis	
R 15-18	08-09	FORESTER GTS All MotorHomes with Ford E350 or E450 Chassis	
R 03-15	08-09	LEXINGTON All MotorHomes with Ford E350 or E450 Chassis	
R 21-24	08-09	SOLERA All MotorHomes with Ford E350 or E450 Chassis	
R 10-15	08-09	SOLERA All MotorHomes with Ford E350 or E450 Chassis	
R 23	08-09	SUNSEEKER	
R 99-06	08-09	SUNSEEKER	
R 07-22	08-09	SUNSEEKER All MotorHomes with Ford E350 or E450 Chassis	
R 19-20	08-09	SUNSEEKER GTS	
R 15-18	08-09	SUNSEEKER GTS All MotorHomes with Ford E350 or E450 Chassis	
R 99-09	08-09	GEORGIE BOY MANUFACTURING CLASS C MOTORHOMES	
R	08-09	GLAVAL BUS CO. VARIOUS	
R	08-09	GOSHEN COACH VARIOUS	
R	08-09	GRECH MOTORS VARIOUS	
R 02-15	08-09	GULF STREAM BT CRUISER	
R 16-24	08-09	BT CRUISER All MotorHomes with Ford E350 or E450 Chassis	
R 99-06	08-09	CAVALIER	
R 12-15	08-09	CONQUEST	
R 93-01	08-09	CONQUEST	
R 16-24	08-09	CONQUEST All MotorHomes with Ford E350 or E450 Chassis	
R 02-11	08-09	CONQUEST All MotorHomes with Ford E350 or E450 Chassis	
R 10-11	08-09	CONQUEST SPORT All MotorHomes with Ford E350 or E450 Chassis	
R 01-02	08-09	CONQUEST SPORT All MotorHomes with Ford E350 or E450 Chassis	
R 00-11	08-09	INDEPENDENCE All MotorHomes with Ford E350 or E450 Chassis	
R 10-11	08-09	MONTAJ All MotorHomes with Ford E350 or E450 Chassis	
R 00-08	08-09	ULTRA	
R 02-04	08-09	YELLOWSTONE	
R 05-11	08-09	YELLOWSTONE All MotorHomes with Ford E350 or E450 Chassis	
R 19	08-09	HOLIDAY RAMBLER ALTERA	
R 18	08-09	ALTERA All MotorHomes with Ford E450 Chassis	
R 08	08-09	ATLANTIS	
R 06	08-09	ATLANTIS	
R 99-01	08-09	ATLANTIS	
R 09-10	08-09	ATLANTIS All MotorHomes with Ford E450 Chassis	
R 07	08-09	ATLANTIS All MotorHomes with Ford E450 Chassis	
R 02-05	08-09	ATLANTIS All MotorHomes with Ford E450 Chassis	
R 19	08-09	AUGUSTA All MotorHomes with Ford E450 Chassis	
R 15-16	08-09	AUGUSTA All MotorHomes with Ford E450 Chassis	
R 11	08-09	AUGUSTA All MotorHomes with Ford E450 Chassis	
R 08-09	08-09	AUGUSTA All MotorHomes with Ford E450 Chassis	
R 12-13	08-09	AUGUSTA B+ All MotorHomes with Ford E450 Chassis	
R 10	08-09	AUGUSTA B+ All MotorHomes with Ford E450 Chassis	
R 07	08-09	AUGUSTA B+ All MotorHomes with Ford E450 Chassis	
R 16	08-09	AUGUSTA LX All MotorHomes with Ford E450 Chassis	

Numerical listing

Shock	POP	Alternative No.	MTG Acc. Supplied
Pos.	Year	Application	
G63623	A (cont)		142617
R	07-10	AUGUSTA SPORT All MotorHomes with Ford E350 Chassis	
R	07-09	AUGUSTA TOURING SEDAN All MotorHomes with Ford E350 Chassis	
R	17-18	VESTA All MotorHomes with Ford E450 Chassis	
R	01-20	ITASCA CLASS C MOTORHOMES	
R	03-06	JAYCO ESCAPADE All MotorHomes with Ford E350 or E450 Chassis	
R	02-06	GRANITE RIDGE All MotorHomes with Ford E350 or E450 Chassis	
R	26	GREYHAWK 29MV With Ford E-450 Super Duty	
R	02-24	GREYHAWK All MotorHomes with Ford E450 Chassis	
R	07-24	MELBOURNE All MotorHomes with Ford E350 or E450 Chassis	
R	13-24	REDHAWK All MotorHomes with Ford E450 Chassis	
R	25	REDHAWK 30Z	
R	26	REDHAWK 31FF	
R	26	REDHAWK SE All With Ford E-350 Super Duty	
R	18-24	REDHAWK SE All MotorHomes with Ford E450 Chassis	
R		KRYSTAL BUS VARIOUS	
R		LGE COACHWORKS VARIOUS	
R	11-20	NEXUS CLASS C MOTORHOMES	
R	11-24	PHANTOM All MotorHomes with Ford E350 or E450 Chassis	
R	20-24	TRIUMPH All MotorHomes with Ford E350 or E450 Chassis	
R	11-24	VIPER All MotorHomes with Ford E350 or E450 Chassis	
R	24	VIPER 29V MotorHomes with Ford E350 or E450 Chassis	
R	00-23	PHOENIX CRUISER All MotorHomes with Ford E350 or E450 Chassis	
R		SHASTA RV ALL MODELS	
R		STARCRAFT BUS CO. E350 & E450 FORD CHASSIS MODELS	
R	92-20	THOMAS TYPE A SCHOOL BUS	
R	26	THOR MOTOR COACH AXIS All With Ford E-450 Super Duty	
R	14-24	AXIS All MotorHomes with Ford E350 or E450 Chassis	
R	99-10	CHATEAU	
R	11-24	CHATEAU All MotorHomes with Ford E350 or E450 Chassis	
R	13	CHATEAU CITATION	
R	08-10	CHATEAU CITATION	
R	11-12	CHATEAU CITATION All MotorHomes with Ford E350 or E450 Chassis	
R	01-11	CITATION	
R	12-16	CITATION All MotorHomes with Ford E350 or E450 Chassis	
R	22-24	ECHELON All MotorHomes with Ford E350 or E450 Chassis	
R	01-10	FOUR WINDS	
R	11-24	FOUR WINDS All MotorHomes with Ford E350 or E450 Chassis	
R	25	FOUR WINDS 282	
R	10-11	FREEDOM ELITE	
R	12-24	FREEDOM ELITE All MotorHomes with Ford E350 or E450 Chassis	
R	11-23	OUTLAW All MotorHomes with Ford E350 or E450 Chassis	
R	26	PASADENA All SE19 Submodel; With Ford E-350 Super Duty	
R	16-24	QUANTUM All MotorHomes with Ford E350 or E450 Chassis	
R	24-25	VEGAS 24.1	
R	14-24	VEGAS All MotorHomes with Ford E350 or E450 Chassis	
R		TURTLETOP BUS VARIOUS	
R		WHEELED COACH IND. VARIOUS	
R	07-13	WINNEBAGO ACCESS All MotorHomes with Ford E350 or E450 Chassis	
R	14	ACCESS PREMIER All MotorHomes with Ford E350 or E450 Chassis	
R	18-20	ASPECT	
R	06-17	ASPECT All MotorHomes with Ford E350 or E450 Chassis	
R	18-20	CAMBRIA	
R	09-15	CAMBRIA	
R	16-17	CAMBRIA All MotorHomes with Ford E350 or E450 Chassis	

Ultra Truck Shock, OffGrid Nomads

Shock	POP	Alternative No.	MTG Acc. Supplied
Pos.	Year	Application	
G63623	A (cont)		142617
R	05-08	CAMBRIA All MotorHomes with Ford E350 or E450 Chassis	
R	06-20	MINNIE	
R	99	MINNIE	
R	00-05	MINNIE All MotorHomes with Ford E350 or E450 Chassis	
R	14-24	MINNIE WINNIE All MotorHomes with Ford E350 or E450 Chassis	
R	00-06	MINNIE WINNIE All MotorHomes with Ford E350 or E450 Chassis	
R	11-18	OUTLOOK	
R	19-21	OUTLOOK All MotorHomes with Ford E350 or E450 Chassis	
R	06-10	OUTLOOK All MotorHomes with Ford E350 or E450 Chassis	
R	08-15	SPIRIT	
R	16-22	SPIRIT All MotorHomes with Ford E350 or E450 Chassis	
R	00-07	SPIRIT All MotorHomes with Ford E350 or E450 Chassis	
R		WORLD TRANS BUS CO. VARIOUS	
G63692	W		
F	93-97	FORD F-SUPER DUTY All Mfg. from 2/93	
F	97	PICKUP, F-450 SUPERDUTY All	
G63809	A		
F	99-04	FORD PICKUP, F-450 SUPERDUTY All	
F	99-04	PICKUP, F-550 SUPERDUTY All	
G63866	A		
R		WORKHORSE VARIOUS	
G63886	A		142731
F	20-24	FORD F-600 SUPER DUTY All Applications with OEM Number	
G63895	A		143276
F	09-22	CHEVROLET EXPRESS 4500 All	
F	10-20	GMC SAVANA 4500 All	
G63897	A		
R	09-22	CHEVROLET EXPRESS 4500 All	
R	10-20	GMC SAVANA 4500 All	
G63969	W		143146
F	05-08	FORD PICKUP, F-450 SUPERDUTY All	
F	05-07	PICKUP, F-550 SUPERDUTY All	
G64177	W		
R	19-22	COACH HOUSE PLATINUM III All MotorHomes with Ford Transit-350 Chassis	
R	26	COACHMEN BEYOND All	
R	19-22	BEYOND All MotorHomes with Ford Transit-350 Chassis	
R	21-22	CROSS TRAIL TRANSIT All MotorHomes with Ford Transit-350 Chassis	
R	17-22	FOREST RIVER FORESTER TS All MotorHomes with Ford Transit-350 Chassis	
R	17-22	SUNSEEKER TS All MotorHomes with Ford Transit-350 Chassis	
R	19-22	LEISURE TRAVEL WONDER All MotorHomes with Ford Transit-350 Chassis	
R	20-22	PHOENIX TRX All MotorHomes with Ford Transit-350 Chassis	
R	19-22	THOR MOTOR COACH GEMINI All MotorHomes with Ford Transit-350 Chassis	
R	21-22	WINNEBAGO EKKO All MotorHomes with Ford Transit-350 Chassis	
OffGrid Nomads			
NM1005	A		142617
F	00-02	FORD E-450 ECONOLINE SUPER DUTY All	
F	21-24	VAN 1 TON, ECONOLINE / CLUB WAGON / SUPERDUTY All	
F	03-19	VAN 1 TON, ECONOLINE / CLUB WAGON / SUPERDUTY All	
NM1010	A		142617
R	00-02	FORD E-450 ECONOLINE SUPER DUTY All	
R	21-24	VAN 1 TON, ECONOLINE / CLUB WAGON / SUPERDUTY All	

Numerical listing

Shock	POP	Alternative No.	MTG Acc. Supplied
Pos.	Year	Application	
NM1010	A (cont)		142617
R	03-19	VAN 1 TON, ECONOLINE / CLUB WAGON / SUPERDUTY All	
NM1015	A		
R	09-22	CHEVROLET EXPRESS 4500 All	
R	10-20	GMC SAVANA 4500 All	
NM1016	A		142376
F	09-22	CHEVROLET EXPRESS 4500 All	
F	10-20	GMC SAVANA 4500 All	

COMPETITIVE & O.E.M. INTERCHANGE LIST
Lista de Intercambios contra Competidores y Equipo Original.
Liste d'interchange de produits compétitifs & déquippement original (OEM)

ACDelco

ACDelco	Gabriel	ACDelco	Gabriel	ACDelco	Gabriel	ACDelco	Gabriel
504-505	49107	508-82	G63410	520-261	82003	530-202	G63411
504-517	49155	508-86	83136	520-293	82035	530-203	G63394
504-520	49162	508-87	85071	520-300	82047	530-223	G63609
504-531	49203	508-90	83136	520-331	82086	530-235	G63625
504-534	49212	509-606	14017	520-40	61542	530-238	G63638
504-539	49218	509-612	6802SE	520-401	61687	530-243	G63662
504-550	49231	509-613	6803SE	520-403	61683	530-247	G63675
504-554	49235	509-626	6853SE	520-407	61684	530-298	G63783
504-562	49311	519-15	43111	520-408	61685	530-311	G63817
507-6	89425	519-2	43048	520-41	61543	530-441	G63893
508-13	85012	519-22	43163	520-42	61544	530-442	G63896
508-13	89413	519-29	43180	520-427	81318	530-443	G63897
508-14	83216	519-30	43181	520-428	81873	530-449	G63894
508-14	85012	519-31	34036	520-429	81920	530-450	G63895
508-14	89413	519-36	34073	520-433	81925	540-5008	77403
508-15	83216	520-1	61500	520-53	61555	540-5010	77375
508-16	83308	520-115	61641	520-61	61565	540-5018	77412
508-17	83312	520-116	61642	520-7	61506	540-5018	77783
508-17	89409	520-135	61663	520-85	61600	540-5032	77488
508-18	83309	520-138	81039	525-16	58403	540-5033	77488
508-19	83314	520-142	81096	525-21	58412	540-5033	77489
508-23	83225	520-145	81113	525-33	58488	540-5040	77609
508-24	83215	520-146	81164	525-34	58489	540-5043	77638
508-30	85005	520-147	81147	525-36	58609	540-5046	77662
508-30	89430	520-150	81242	525-42	58638	540-5062	77783
508-35	G63306	520-152	81270	525-44	58662	540-5069	77817
508-39	G63347	520-154	81340	525-6	58357	540-5077	77907
508-42	G63353	520-157	81394	525-66	58817	550-13	85005
508-47	G63350	520-16	61516	525-68	58930	550-13	89430
508-48	G63409	520-164	81510	530-129	G63347	550-73	85005
508-5	G63359	520-165	81082	530-130	G63349	550-73	89430
508-5	G63360	520-17	61517	530-133	G63355	550-77	83221
508-50	G63299	520-178	81490	530-134	G63357	88945297	G63347
508-52	G63405	520-183	81496	530-147	G63403	88945315	G63403
508-57	83123	520-184	81484	530-147	G63413	88945315	G63413
508-57	89405	520-19	61519	530-151	G63366	88945361	G63492
508-59	G63183	520-214	81667	530-175	G63375	88945403	G63625
508-68	83209	520-215	81668	530-189	G63488	88945411	G63662
508-68	85006	520-22	61522	530-189	G63609	88945415	G63675
508-68	89414	520-227	81713	530-190	G63489		
508-71	83314	520-24	61524	530-193	G63492		
508-72	G63386	520-25	61525	530-201	G63403		

ACDelco Long Number

ACDelco Long Number	Gabriel	ACDelco Long Number	Gabriel	ACDelco Long Number	Gabriel	ACDelco Long Number	Gabriel
88945297	G63347	88945315	G63413	88945370	G63411	88945415	G63675
88945302	G63357	88945361	G63492	88945403	G63625		
88945315	G63403	88945369	G63403	88945411	G63662		

ACDelco Short Number

ACDelco Short Number	Gabriel	ACDelco Short Number	Gabriel	ACDelco Short Number	Gabriel	ACDelco Short Number	Gabriel
508-42	G63353	530-147	G63403	530-201	G63403	530-298	G63783
508-5	G63359	530-147	G63413	530-202	G63411	530-311	G63817
508-5	G63360	530-151	G63366	530-203	G63394	530-441	G63893
508-82	G63410	530-175	G63375	530-223	G63609	530-442	G63896
530-129	G63347	530-189	G63488	530-235	G63625		
530-130	G63349	530-189	G63609	530-238	G63638		
530-133	G63355	530-190	G63489	530-243	G63662		
530-134	G63357	530-193	G63492	530-247	G63675		

Important Note: Competitive Interchanges are to be used for stocking purposes only. Where multiple crosses are identified, please reference the applications section of this catalog. / **Remarque importante:** Les interchanges concurrentiels ne s'utilisent qu'aux fins de stocks. Dans le cas de références multiples, consulter la section des applications du catalogue. / **Nota importante:** Dans le cas de références multiples, consulter la section des applications du catalogue. / **Nota importante:** Se pueden usar intercambios competitivos para propósitos de almacenamiento solamente. Cuando se identifican intercambios múltiples, consulte la sección de aplicaciones de este catálogo.

COMPETITIVE & O.E.M. INTERCHANGE LIST
Lista de Intercambios contra Competidores y Equipo Original.
Liste d'interchange de produits compétitifs & déquippement original (OEM)

ACDelco Short Number... cont'd

ACDelco Short NumberGabriel	ACDelco Short NumberGabriel	ACDelco Short NumberGabriel	ACDelco Short NumberGabriel
530-443 G63897	530-449 G63894	530-450 G63895	

ACF Brill Bus

ACF Brill Bus Gabriel	ACF Brill Bus Gabriel	ACF Brill Bus Gabriel	ACF Brill Bus Gabriel
661732 83215	661733 83225		

Advance AutoParts

Advance AutoParts Gabriel	Advance AutoParts Gabriel	Advance AutoParts Gabriel	Advance AutoParts Gabriel
34504 81925	471128R G57206	59061 81920	59562 61518
34732 81821	55818 81340	59086 81713	59567 61554
34761 81828	55818 82155	59090 81726	59571 82003
34762 G63896	5751 82026	59304 61506	59574 61516
34791 G63692	58581 61544	59305 61555	59574 61519
34912 G63625	58599 61656	59306 61500	59577 61547
34919 G63411	59001 81318	59309 61591	59578 81510
37044 G63488	59003 81147	59402 61592	59582 61542
37050 G63489	59004 81825	59505 61520	59583 61543
37073 G63492	59006 81394	59505 61546	59586 61614
37091 G63413	59007 81242	59512 61632	59588 61530
37094 G63353	59011 81484	59512 81091	59589 61641
37095 G63410	59017 81676	59517 61646	59592 61642
37096 G63359	59017 82007	59519 61687	59592 81873
37102 G63661	59028 81668	59520 61565	59592 81921
37104 G63673	59029 81667	59523 61599	59596 61680
37117 G63623	59031 81490	59525 61634	59597 61654
37130 G63609	59032 81710	59528 61635	59598 61655
37149 G63783	59034 81082	59542 61525	59614 61663
37152 G63675	59036 81744	59544 61524	66415 G63918
37187 82035	59041 81039	59547 81096	911039 G63456
37206 G64009	59042 81113	59549 61517	911267 G63888
37290 G64042	59044 81164	59554 61521	911299 G64043
471128L G57206	59045 81496	59561 61522	

Advance Mixer

Advance Mixer Gabriel	Advance Mixer Gabriel	Advance Mixer Gabriel	Advance Mixer Gabriel
14626 ADV 83209	14626 ADV 89414		

AL-KO

AL-KO Gabriel	AL-KO Gabriel	AL-KO Gabriel	AL-KO Gabriel
813009 G63886	813030 G63413	813046 G64010	813065 G64011
813011 G63783	813031 G63638	813050 G63837	813100 G63897
813021 G63888	813035 G63403	813051 G63809	813107 G63918
813026 G63817	813037 G63609	813053 G63808	
813030 G63347	813038 G63489	813054 G63607	
813030 G63405	813040 G63488	813059 G64043	

Allco Trailer

Allco Trailer Gabriel	Allco Trailer Gabriel	Allco Trailer Gabriel	Allco Trailer Gabriel
727602 83122	727602 89406		

Alliance

Alliance Gabriel	Alliance Gabriel	Alliance Gabriel	Alliance Gabriel
ABP N32 G900001 85724	ABP N32 G900027 85331	ABP N32 G900054 89430	ABP N32 G900089 85932
ABP N32 G900001 89443	ABP N32 G900030 83127	ABP N32 G900056 83126	ABP N32 G900089 89453
ABP N32 G900003 85918	ABP N32 G900031 85311	ABP N32 G900056 89430	ABP N32 G900094 85084
ABP N32 G900003 89449	ABP N32 G900031 89424	ABP N32 G900061 85072	ABP N32 G900094 89460
ABP N32 G900006 83456	ABP N32 G900038 85069	ABP N32 G900072 85656	ABP N32 O900001 85724
ABP N32 G900006 89447	ABP N32 G900038 89455	ABP N32 G900073 85058	ABP N32 O900001 89443
ABP N32 G900009 85006	ABP N32 G900047 85900	ABP N32 G900073 89431	ABP N32 O900003 85918
ABP N32 G900010 85013	ABP N32 G900049 85957	ABP N32 G900075 85919	
ABP N32 G900010 89414	ABP N32 G900050 83135	ABP N32 G900076 85012	
ABP N32 G900013 89458	ABP N32 G900051 83317	ABP N32 G900076 89413	
ABP N32 G900018 83021	ABP N32 G900054 85005	ABP N32 G900083 85029	

Important Note: Competitive Interchanges are to be used for stocking purposes only. Where multiple crosses are identified, please reference the applications section of this catalog. / **Remarque importante:** Les interchanges concurrentiels ne s'utilisent qu'aux fins de stocks. Dans le cas de références multiples, consulter la section des applications du catalogue. / **Nota importante:** Dans le cas de références multiples, consulter la section des applications du catalogue. / **Nota importante:** Se pueden usar intercambios competitivos para propósitos de almacenamiento solamente. Cuando se identifican intercambios múltiples, consulte la sección de aplicaciones de este catálogo.

COMPETITIVE & O.E.M. INTERCHANGE LIST
Lista de Intercambios contra Competidores y Equipo Original.
Liste d'interchange de produits compétitifs & déquippement original (OEM)

Alliance... cont'd

Alliance	Gabriel	Alliance	Gabriel	Alliance	Gabriel	Alliance	Gabriel
ABP N32 O900003	89449	ABP N32 O900030	83127	ABP N32 O900054	85005	ABP N32 O900076	85012
ABP N32 O900006	83456	ABP N32 O900031	85311	ABP N32 O900054	89430	ABP N32 O900076	89413
ABP N32 O900006	89447	ABP N32 O900031	89424	ABP N32 O900056	83126	ABP N32 O900083	85029
ABP N32 O900009	85006	ABP N32 O900038	85069	ABP N32 O900056	89430	ABP N32 O900089	85932
ABP N32 O900010	85013	ABP N32 O900038	89455	ABP N32 O900061	85072	ABP N32 O900089	89453
ABP N32 O900010	89414	ABP N32 O900047	85900	ABP N32 O900072	85656	ABP N32 O900092	83163
ABP N32 O900013	89458	ABP N32 O900049	85957	ABP N32 O900073	85058	ABP N32 O900093	83137
ABP N32 O900018	83021	ABP N32 O900050	83135	ABP N32 O900073	89431		
ABP N32 O900027	85331	ABP N32 O900051	83317	ABP N32 O900075	85919		

Aralmex

Aralmex	Gabriel	Aralmex	Gabriel	Aralmex	Gabriel	Aralmex	Gabriel
2AMG037	G63375	3AMG005	G63359	3AMG021	G63409	3AMG031	G63360
3AMG001	G63355	3AMG006	G63377	3AMG026	G63455	3AMG033	G63614
3AMG004	G63306	3AMG007	G63357	3AMG029	G63488	3AMG035	G63607

Arvin Meritor

Arvin Meritor	Gabriel	Arvin Meritor	Gabriel	Arvin Meritor	Gabriel	Arvin Meritor	Gabriel
085009	85009	695180	85705	727639	89409	728624	85012
654958	83164	695180	89447	727641	83314	728624	89413
665044	83209	727609	83209	727671	83613	728625	85013
665044	89414	727609	89414	728615	85311	728625	89414
671091	85069	727615	83215	728615	89424	728628	89425
671091	89455	727616	83216	728617	85005	728631	85029
671092	85012	727625	83225	728617	89430	728812	85705
671092	89413	727635	83308	728618	85006	728812	89447
680464	85005	727636	83309	728621	85009		
680464	89430	727639	83312	728622	85010		

Aurora Parts and Service

Aurora Parts and Service	Gabriel	Aurora Parts and Service	Gabriel	Aurora Parts and Service	Gabriel	Aurora Parts and Service	Gabriel
PROSH85724	85724						

AutoAnything

AutoAnything	Gabriel	AutoAnything	Gabriel	AutoAnything	Gabriel	AutoAnything	Gabriel
AA61500	61500	AA61642	61642	AA82066	82066	AAG63455	G63455
AA61506	61506	AA61646	61646	AA82086	82086	AAG63456	G63456
AA61516	61516	AA61654	61654	AA82155	82155	AAG63461	G63461
AA61517	61517	AA61655	61655	AAG56778	G56778	AAG63488	G63488
AA61518	61518	AA61656	61656	AAG63183	G63183	AAG63489	G63489
AA61519	61519	AA61663	61663	AAG63299	G63299	AAG63492	G63492
AA61520	61520	AA61680	61680	AAG63306	G63306	AAG63607	G63607
AA61521	61521	AA61682	61682	AAG63347	G63347	AAG63609	G63609
AA61522	61522	AA61687	61687	AAG63349	G63349	AAG63610	G63610
AA61523	61523	AA61714	61714	AAG63350	G63350	AAG63614	G63614
AA61524	61524	AA61716	61716	AAG63353	G63353	AAG63622	G63622
AA61525	61525	AA77412	77412	AAG63355	G63355	AAG63623	G63623
AA61530	61530	AA77488	77488	AAG63357	G63357	AAG63638	G63638
AA61542	61542	AA77489	77489	AAG63359	G63359	AAG63661	G63661
AA61543	61543	AA77609	77609	AAG63360	G63360	AAG63662	G63662
AA61546	61546	AA77638	77638	AAG63366	G63366	AAG63671	G63671
AA61547	61547	AA77662	77662	AAG63375	G63375	AAG63673	G63673
AA61554	61554	AA77783	77783	AAG63377	G63377	AAG63674	G63674
AA61565	61565	AA77817	77817	AAG63386	G63386	AAG63675	G63675
AA61591	61591	AA77948	77948	AAG63387	G63387	AAG63783	G63783
AA61599	61599	AA77950	77950	AAG63403	G63403	AAG63808	G63808
AA61600	61600	AA81825	81825	AAG63405	G63405	AAG63809	G63809
AA61614	61614	AA81928	81928	AAG63409	G63409		
AA61634	61634	AA82007	82007	AAG63410	G63410		
AA61635	61635	AA82012	82012	AAG63411	G63411		
AA61641	61641	AA82065	82065	AAG63413	G63413		

Important Note: Competitive Interchanges are to be used for stocking purposes only. Where multiple crosses are identified, please reference the applications section of this catalog. / **Remarque importante:** Les interchanges concurrentiels ne s'utilisent qu'aux fins de stocks. Dans le cas de références multiples, consulter la section des applications du catalogue. / **Nota importante:** Dans le cas de références multiples, consulter la section des applications du catalogue. / **Nota importante:** Se pueden usar intercambios competitivos para propósitos de almacenamiento solamente. Cuando se identifican intercambios múltiples, consulte la sección de aplicaciones de este catálogo.

COMPETITIVE & O.E.M. INTERCHANGE LIST
Lista de Intercambios contra Competidores y Equipo Original.
Liste d'interchange de produits compétitifs & équipement original (OEM)

AutoAnything... cont'd

AutoAnything	Gabriel	AutoAnything	Gabriel	AutoAnything	Gabriel	AutoAnything	Gabriel
AAG63810	G63810	AAG63893	G63893	AAG63918	G63918	AAG64011	G64011
AAG63817	G63817	AAG63894	G63894	AAG63969	G63969	AAG64013	G64013
AAG63837	G63837	AAG63895	G63895	AAG63971	G63971	AAG64042	G64042
AAG63886	G63886	AAG63896	G63896	AAG64009	G64009	AAG64043	G64043
AAG63888	G63888	AAG63897	G63897	AAG64010	G64010		

Autocar LLC

Autocar LLC	Gabriel	Autocar LLC	Gabriel	Autocar LLC	Gabriel	Autocar LLC	Gabriel
03-1106460	85005	60657-003	85072	60670005L	83137	60680005	83142
03-1106460	89430	60657-003L	85072	60675-003	85976	60680005L	83142
031106460	85005	60657003	85072	60675-003L	85976	660186	83216
031106460	89430	60657003L	85072	60675003	85976	727602	83122
1011839	83216	60665-025	89405	60675003L	85976	727602	89406
28CFG-910	83216	60665-025L	89405	60680-004	83143	800781	89425
28CFG-910Z	83216	60665025	89405	60680-004L	83143	849246	83216
28CFG910	83216	60665025L	89405	60680-005	83142	A3591004-001	85072
28CFG910Z	83216	60670-005	83137	60680-005L	83142	A3591004001	85072
28R010	83216	60670-005L	83137	60680004	83143		
3946210	83103	60670005	83137	60680004L	83143		

AUTOMANN

AUTOMANN	Gabriel	AUTOMANN	Gabriel	AUTOMANN	Gabriel	AUTOMANN	Gabriel
A83021	83021	A83143	83143	A85006	85006	A85927	85927
A83025	83025	A83163	83163	A85012	85012	A85928	85928
A83054	83054	A83166	83166	A85013	85013	A85956	85956
A83066	83066	A83169	83169	A85029	85029	A85957	85957
A83101	83101	A83175	83175	A85058	85058	A85976	85976
A83103	83103	A83209	83209	A85069	85069	A85979	85979
A83123	83123	A83215	83215	A85072	85072	A85989	85989
A83131	83131	A83312	83312	A85084	85084	A89414	89414
A83134	83134	A83317	83317	A85188	85188	A89424	89424
A83135	83135	A83364	83364	A85311	85311	A89443	89443
A83136	83136	A83391	83391	A85642	85642	A89455	89455
A83137	83137	A83395	83395	A85724	85724	A89460	89460
A83140	83140	A83456	83456	A85900	85900	AG63809	G63809
A83142	83142	A85005	85005	A85918	85918		

Autopart International

Autopart International	Gabriel	Autopart International	Gabriel	Autopart International	Gabriel	Autopart International	Gabriel
2701-204605	81921	2701-460070	G63886	2701-80882	81484	2701-82574	81925
2701-204612	G63455	2701-460070	G63969	2701-80893	81164	2701-82584	G63809
2701-204663	81919	2701-460071	G63969	2701-80898	G63353	2701-82585	G63410
2701-233579	6828SE	2701-460072	G63969	2701-80899	81096	2701-82586	G63387
2701-233580	6854SE	2701-460073	G64010	2701-80900	81496	2701-82587	81394
2701-233597	6847SE	2701-460074	G63622	2701-80901	81082	2701-82588	G63366
2701-248157	G63607	2701-460077	G63888	2701-80901	81510	2701-82592	G63183
2701-248158	G63837	2701-524158	G57206	2701-80901	81710	2725-539606	58662
2701-248163	G63692	2701-730414	G57852	2701-80903	81091	2725-539606	58930
2701-248173	G63896	2701-730415	G57853	2701-80908	82066	2725-539620	58817
2701-248175	G63893	2701-80645	81713	2701-80916	G63610	2725-539627	58609
2701-248177	G63894	2701-80655	81667	2701-80934	G63492	2725-539634	58809
2701-424152	G63971	2701-80656	81668	2701-80936	G63299	2725-539635	58807
2701-424153	G64043	2701-80657	81726	2701-80952	G63350	2725-539642	G64011
2701-424206	G64042	2701-80658	81744	2701-80958	81873	2725-539650	58623
2701-424216	G56778	2701-80685	G63810	2701-80962	81828	2725-539651	58622
2701-424682	G63808	2701-80875	81490	2701-80963	81928	2725-546476	58488
2701-424893	G63674	2701-80876	81039	2701-82573	81920		

Important Note: Competitive Interchanges are to be used for stocking purposes only. Where multiple crosses are identified, please reference the applications section of this catalog. / **Remarque importante:** Les interchanges concurrentiels ne s'utilisent qu'aux fins de stocks. Dans le cas de références multiples, consulter la section des applications du catalogue. / **Nota importante:** Dans le cas de références multiples, consulter la section des applications du catalogue. / **Nota importante:** Se pueden usar intercambios competitivos para propósitos de almacenamiento solamente. Cuando se identifican intercambios múltiples, consulte la sección de aplicaciones de este catálogo.

COMPETITIVE & O.E.M. INTERCHANGE LIST
Lista de Intercambios contra Competidores y Equipo Original.
Liste d'interchange de produits compétitifs & déquippement original (OEM)

AutoZone

AutoZone	Gabriel	AutoZone	Gabriel	AutoZone	Gabriel	AutoZone	Gabriel
344426	81676	TS33-30892B	81873	TS34-31021B	81726	TS34-32162B	61654
61655	61655	TS33-30892B	81928	TS34-31342B	81921	TS34-32172B	61614
LS54-94321B	G57206	TS33-31402B	81828	TS34-31361B	81920	TS34-32252B	81496
LS54-94331B	G57206	TS33-31452B	61656	TS34-31391B	81744	TS34-32261B	81919
TS32-30072B	G64042	TS33-32351B	81113	TS34-31422B	81925	TS34-32321B	81096
TS32-30102B	81147	TS33-32542B	81490	TS34-31432B	81667	TS34-32423B	81242
TS32-30171B	G63614	TS33-32542B	81710	TS34-31441B	G63809	TS34-32632B	81825
TS32-30261B	81394	TS33-32573B	82007	TS34-31672B	81082	TS34-32671B	81834
TS32-34011B	82026	TS33-32641B	81821	TS34-31691B	81668	TS34-32911B	G64043
TS32-34032B	82065	TS33-32813B	81484	TS34-32072B	81713	TS34-33012B	G63837
TS32-34092B	82155	TS33-33032B	82003	TS34-32102B	81164	TS34-34511B	82012
TS32-34172B	82066	TS33-34381B	82047	TS34-32111B	81039		
TS32-34341B	82035	TS34-30953B	61506	TS34-32141B	61546		
TS32-34352B	82086	TS34-30953B	81318	TS34-32152B	81510		

Batco

Batco	Gabriel	Batco	Gabriel	Batco	Gabriel	Batco	Gabriel
1083209	83209	1083310	83221	1085005	89430		
1083209	89414	1083317	83317	1085311	85311		
1083225	83225	1085005	85005	1085311	89424		

Bering Truck Corp.

Bering Truck Corp.	Gabriel	Bering Truck Corp.	Gabriel	Bering Truck Corp.	Gabriel	Bering Truck Corp.	Gabriel
47902-24	83137	4790224	83137				

Berkshire Coach

Berkshire Coach	Gabriel	Berkshire Coach	Gabriel	Berkshire Coach	Gabriel	Berkshire Coach	Gabriel
8C24-18045-DA	G63622	8C2418080DB	G63623	8C2Z18124D	G63622	ASH-1154	G63622
8C24-18080-DB	G63623	8C2Z-18124-D	G63622	8C2Z18125D	G63623	ASH1136	G63623
8C2418045DA	G63622	8C2Z-18125-D	G63623	ASH-1136	G63623	ASH1154	G63622

Bilstein

Bilstein	Gabriel	Bilstein	Gabriel	Bilstein	Gabriel	Bilstein	Gabriel
14-186629	85125	24-153256	85124	B46-1725	85029	F4-BE5-B492-H0	85125
24-015943	85013	24-186414	85029	F4-B46-1594-H0	85013	F4-BE5-F324-H0	85125
24-015943	89414	B46-1594	85013	F4-B46-1594-H0	89414	F4-BE5-F325-H0	85124
24-153249	85125	B46-1594	89414	F4-B46-1725-H2	85029		

Blue Bird

Blue Bird	Gabriel	Blue Bird	Gabriel	Blue Bird	Gabriel	Blue Bird	Gabriel
00020317	89405	2021459	85012	59057001	83137	70397	85006
00085991	85006	2021459	89413	59057002	89405	7805-M-1001	85919
00119798	85106	23106-01	89430	59483-000	85919	7805M1001	85919
0014605	89405	300-1316546	85006	59483000	85919	8C24-18045-DA	G63622
0014985	83137	300-1317767	85029	60665-004	89405	8C24-18080-DB	G63623
0015222	85919	3001316546	85006	60665-005	85919	8C2418045DA	G63622
0020326	85976	3001317767	85029	60665-005L	85919	8C2418080DB	G63623
0040015	85919	471700000428	85006	60665003	83137	8C2Z-18124-D	G63622
0106303	85106	471700000430	85006	60665005	85919	8C2Z-18125-D	G63623
060665-003	83137	471700002919	85106	60665005L	85919	8C2Z18124D	G63622
060665-004	89405	471700002920	85106	60998-001	85006	8C2Z18125D	G63623
1316546	85006	471700131545	85006	60998-002	85919	90044915	83127
1317767	85029	471700131550	85006	60998-002L	85919	AMS65109	85058
1658533	85010	4759272	89447	60998-003	85006	AMS65109	89431
1668731	85029	481700131438	85919	60998001	85006	AMS65110	85005
1668730	85013	481700131440	85919	60998002	85919	AMS65110	89430
1668730	89414	58913-010	85106	60998002L	85919	AMS65119	85029
1707405	85005	58913-010L	85106	60998003	85006	ASH-1136	G63623
1707405	89430	58913010	85106	65992-004	85106		
1722222	85013	58913010L	85106	65992004	85106		
1722222	89414	59057-001	83137	671933	85919		
1746163	85006	59057-002	89405	680667	89447		

Important Note: Competitive Interchanges are to be used for stocking purposes only. Where multiple crosses are identified, please reference the applications section of this catalog./ **Remarque importante:** Les interchanges concurrentiels ne s'utilisent qu'aux fins de stocks. Dans le cas de références multiples, consulter la section des applications du catalogue./ **Nota importante:** Dans le cas de références multiples, consulter la section des applications du catalogue./ **Nota importante:** Se pueden usar intercambios competitivos para propósitos de almacenamiento solamente. Cuando se identifican intercambios múltiples, consulte la sección de aplicaciones de este catálogo.

COMPETITIVE & O.E.M. INTERCHANGE LIST
Lista de Intercambios contra Competidores y Equipo Original.
Liste d'interchange de produits compétitifs & équipement original (OEM)

Blue Bird... cont'd

Blue Bird	Gabriel	Blue Bird	Gabriel	Blue Bird	Gabriel	Blue Bird	Gabriel
ASH-1154	G63622	ASH1154	G63622	AT-164G	G63623	AT164G	G63623
ASH1136	G63623	AT-163G	G63622	AT163G	G63622		

BOGE

BOGE	Gabriel	BOGE	Gabriel	BOGE	Gabriel	BOGE	Gabriel
2001	81394	83-263-5	81676	83-510-0	81873	83-524-9	61710
2002	81147	83-263-9	G63377	83-510-1	61634	930 041	58930
2501	G63386	83-501-6	61521	83-510-1	61635	930002	G63403
2504	G63349	83-501-6	82012	83-510-1	81919	930003	77675
2505	G63355	83-502-0	61500	83-510-7	58622	930004	77949
2516	G63377	83-502-0	61506	83-510-7	58807	930004	77950
2519	G63488	83-502-0	77907	83-510-7	58929	930006	G63353
2521	G63896	83-503-8	61524	83-510-7	61591	930012	77661
2522	G63896	83-503-9	61525	83-510-7	77608	930013	61716
2525	G63662	83-503-9	81039	83-510-7	77614	930022	77808
2526	G63673	83-505-3	61520	83-510-7	77807	930023	G63409
2541	G64042	83-505-3	61546	83-510-7	81744	930024	58809
2548	G63607	83-505-3	77414	83-511-5	61646	930026	77810
2566	G63783	83-505-3	77455	83-511-5	77623	930032	G63349
2568	G63614	83-505-3	81394	83-511-5	81828	930032	G63488
2581	G63492	83-505-3	81490	83-512-0	58357	930033	77948
2591	G63662	83-505-3	81744	83-512-0	61517	930034	58488
32002	81270	83-505-4	61518	83-512-1	58638	930034	77488
32051	81340	83-505-4	61530	83-512-1	61516	930035	G63675
32276	81713	83-505-4	61547	83-512-1	61519	930037	77638
33001	6802SE	83-505-4	61554	83-512-1	61522	930039	61506
33002	6847SE	83-505-4	61654	83-512-1	81484	930039	81318
33005	6804SE	83-505-4	61713	83-518-3	77607	930041	77976
34-508-0	77614	83-505-4	77461	83-518-4	58808	930045	G63492
35039	61525	83-505-4	81082	83-518-5	61614	930048	G63359
35039	81039	83-505-4	81510	83-519-0	61680	930048	G63661
35084	81342	83-505-4	81710	83-519-0	77809	930049	58944
35085	61632	83-509-0	58359	83-519-0	77837	930049	77673
35085	81825	83-509-0	61523	83-519-0	77951	930049	77674
35087	82065	83-509-0	81096	83-520-6	58817	930049	77967
35091	58489	83-509-0	81834	83-520-6	61641	930050	G63410
35091	61544	83-509-1	58489	83-520-6	61663	930050	G63614
35091	77489	83-509-1	61544	83-520-6	77783	930051	77968
35091	81668	83-509-1	61555	83-520-6	81920	930051	77969
35115	58623	83-509-1	77489	83-520-6	81925	930052	77817
35115	81242	83-509-1	81668	83-521-1	61710	930053	G63355
35257	58609	83-509-2	61543	83-521-6	61600	930063	G63918
35257	77609	83-509-2	81667	83-523-4	81318	930130	G63299
35257	81496	83-509-3	61565	83-523-7	61655	930146	61714
83-205-7	81821	83-509-7	58638	83-523-8	58810	930165	G64089
83-227-6	77375	83-509-7	61687	83-523-8	61656	950 006	G56778
83-228-0	81147	83-509-7	81164	83-524-1	58662	950 014	G56778
83-241-9	61506	83-509-9	61599	83-524-1	61600	950 124	G64042
83-241-9	81318	83-510-0	61642	83-524-8	81928		

Boystun Equipment Manufacturing

Boystun Equipment Manufacturing	Gabriel	Boystun Equipment Manufacturing	Gabriel	Boystun Equipment Manufacturing	Gabriel	Boystun Equipment Manufacturing	Gabriel
1253069B000	85005	1253069B000	89430				

Brockway School Bus

Brockway School Bus	Gabriel	Brockway School Bus	Gabriel	Brockway School Bus	Gabriel	Brockway School Bus	Gabriel
14QK-282P1	83216	14QK282P1	83216	152412	83215		
14QK-282P3	83216	14QK282P3	83216				

Important Note: Competitive Interchanges are to be used for stocking purposes only. Where multiple crosses are identified, please reference the applications section of this catalog. / **Remarque importante:** Les interchanges concurrentiels ne s'utilisent qu'aux fins de stocks. Dans le cas de références multiples, consulter la section des applications du catalogue. / **Nota importante:** Dans le cas de références multiples, consulter la section des applications du catalogue. / **Nota importante:** Se pueden usar intercambios competitivos para propósitos de almacenamiento solamente. Cuando se identifican intercambios múltiples, consulte la sección de aplicaciones de este catálogo.

COMPETITIVE & O.E.M. INTERCHANGE LIST
Lista de Intercambios contra Competidores y Equipo Original.
Liste d'interchange de produits compétitifs & déquippement original (OEM)

Built Rite

Built Rite	Gabriel	Built Rite	Gabriel	Built Rite	Gabriel	Built Rite	Gabriel
318-06-100	85006	31806100	85006				

Bull Dog

Bull Dog	Gabriel	Bull Dog	Gabriel	Bull Dog	Gabriel	Bull Dog	Gabriel
HD1114-0258	83169	HD1214-0568	83225	HD1215-0031	89455	HD1215-0084	83135
HD1116-0033	85311	HD1214-0570	89430	HD1215-0033	85311	HD1215-0084	83163
HD1116-0033	89424	HD1214-0571	83159	HD1215-0033	89424	HD1215-0088	85006
HD1116-0059	85332	HD1214-0572	83163	HD1215-0041	89458	HD1215-0091	89430
HD1213-0651	83021	HD1214-0573	83025	HD1215-0043	85013	HD1215-0092	89430
HD1213-0705	85006	HD1214-0574	83103	HD1215-0043	89414	HD1215-0093	83209
HD1214-0497	83054	HD1214-0579	83221	HD1215-0045	85013	HD1215-0093	89414
HD1214-0526	83613	HD1214-0580	83209	HD1215-0045	89414	HD1215-0094	83142
HD1214-0530	83123	HD1214-0580	89414	HD1215-0048	85084	HD1215-0095	83175
HD1214-0530	89405	HD1214-0593	83120	HD1215-0048	85989	HD1215-0096	85029
HD1214-0534	83127	HD1214-0595	83308	HD1215-0048	89460	HD1215-0103	85932
HD1214-0539	83126	HD1214-0602	83120	HD1215-0055	85656	HD1215-0103	89453
HD1214-0539	89430	HD1214-0605	85012	HD1215-0056	85012	HD1215-0104	85956
HD1214-0540	83515	HD1214-0605	89413	HD1215-0056	89413	HD1215-0110	83122
HD1214-0545	83456	HD1214-0607	83154	HD1215-0059	83123	HD1215-0110	89406
HD1214-0545	89447	HD1214-0611	83134	HD1215-0059	89405	HD1215-0111	85043
HD1214-0550	83314	HD1214-0640	83216	HD1215-0061	85012	HD1215-0114	85058
HD1214-0551	83126	HD1214-0641	83216	HD1215-0061	89413	HD1215-0114	89431
HD1214-0551	89430	HD1214-0642	83135	HD1215-0063	83317	HD1215-0115	85058
HD1214-0556	83136	HD1214-0656	83103	HD1215-0066	85029	HD1215-0115	89431
HD1214-0557	83101	HD1214-0657	83164	HD1215-0069	85072	HD1215-0116	85058
HD1214-0558	83169	HD1214-0658	83308	HD1215-0071	85005	HD1215-0116	89431
HD1214-0559	83309	HD1215-0018	85724	HD1215-0071	89430	HD1215-0118	83160
HD1214-0560	83141	HD1215-0018	89443	HD1215-0073	85976	HD1215-0123	83131
HD1214-0561	85071	HD1215-0022	85928	HD1215-0076	85069	HD1215-0132	83143
HD1214-0562	83312	HD1215-0022	85957	HD1215-0076	89455	HD1215-0133	83122
HD1214-0562	89409	HD1215-0023	85031	HD1215-0077	85900	HD1215-0133	89406
HD1214-0563	83215	HD1215-0024	85918	HD1215-0078	89405	HD1215-0147	85927
HD1214-0564	83312	HD1215-0024	89449	HD1215-0079	85919	HD1215-0148	85181
HD1214-0564	89409	HD1215-0025	85918	HD1215-0081	83136	HD1215-0150	85029
HD1214-0566	83123	HD1215-0025	89449	HD1215-0082	85311	HD1215-0151	85010
HD1214-0566	89405	HD1215-0026	85331	HD1215-0082	89424	HD1215-0156	83136
HD1214-0567	83215	HD1215-0031	85069	HD1215-0083	85978	HD1215-0160	85125

CargoMaxx

CargoMaxx	Gabriel	CargoMaxx	Gabriel	CargoMaxx	Gabriel	CargoMaxx	Gabriel
441 - 83021	83021	441 - 83209	83209	441 - 85012	89413	441 - 850695528	89455
441 - 83025	83025	441 - 83209	89414	441 - 850125113	85012	441 - 85072	85072
441 - 83122	83122	441 - 83215	83215	441 - 850125113	89413	441 - 85084	85084
441 - 83122	89406	441 - 83221	83221	441 - 850135401	85013	441 - 85084	89460
441 - 83123	83123	441 - 83309	83309	441 - 850135401	89414	441 - 853114417	85311
441 - 83123	89405	441 - 833126668	83312	441 - 850135420	85013	441 - 853114417	89424
441 - 831266833	83126	441 - 833126668	89409	441 - 850135420	89414	441 - 853115402	85311
441 - 831266833	89430	441 - 833126811	83312	441 - 85029	85029	441 - 853115402	89424
441 - 831266897	83126	441 - 833126811	89409	441 - 850295451	85029	441 - 853115444	85311
441 - 831266897	89430	441 - 83317	83317	441 - 85031	85031	441 - 853115444	89424
441 - 831266969	83126	441 - 83456	83456	441 - 850365411	89405	441 - 85724	85724
441 - 831266969	89430	441 - 83456	89447	441 - 850365481	89405	441 - 85724	89443
441 - 83127	83127	441 - 83515	83515	441 - 850585109	85058	441 - 85900	85900
441 - 83136	83136	441 - 83613	83613	441 - 850585109	89431	441 - 859185140	85918
441 - 83142	83142	441 - 85005	85005	441 - 850585478	85058	441 - 859185140	89449
441 - 83143	83143	441 - 85005	89430	441 - 850585478	89431		
441 - 83156	83169	441 - 850065482	85006	441 - 850695468	85069		
441 - 831635143	83163	441 - 850065505	85006	441 - 850695468	89455		
441 - 831636422	83163	441 - 85012	85012	441 - 850695528	85069		

Important Note: Competitive Interchanges are to be used for stocking purposes only. Where multiple crosses are identified, please reference the applications section of this catalog. / **Remarque importante:** Les interchanges concurrentiels ne s'utilisent qu'aux fins de stocks. Dans le cas de références multiples, consulter la section des applications du catalogue. / **Nota importante:** Dans le cas de références multiples, consulter la section des applications du catalogue. / **Nota importante:** Se pueden usar intercambios competitivos para propósitos de almacenamiento solamente. Cuando se identifican intercambios múltiples, consulte la sección de aplicaciones de este catálogo.

COMPETITIVE & O.E.M. INTERCHANGE LIST
Lista de Intercambios contra Competidores y Equipo Original.
Liste d'interchange de produits compétitifs & déquippement original (OEM)

CargoMaxx... cont'd

CargoMaxx	Gabriel	CargoMaxx	Gabriel	CargoMaxx	Gabriel	CargoMaxx	Gabriel
441 - 859185148	85918	441 - 85931	89458	441 - 85957	85957	441-853114417	85311
441 - 859185148	89449	441 - 85932	85932	441 - 85976	85976	441-853115402	85311
441 - 85919	85919	441 - 85932	89453	441 - 85978	85978	441-853115444	85311
441 - 85926	85656	441 - 85956	85956	441-65514	89405		

Carquest

Carquest	Gabriel	Carquest	Gabriel	Carquest	Gabriel	Carquest	Gabriel
MON-65420	85013						

Caterpillar

Caterpillar	Gabriel	Caterpillar	Gabriel	Caterpillar	Gabriel	Caterpillar	Gabriel
60657-003	85072	60670-005L	83137	60680-005	83142	60680005L	83142
60657-003L	85072	60670005	83137	60680-005L	83142	H60680004	83143
60657003	85072	60670005L	83137	60680004	83143	HDR60680-005	83142
60657003L	85072	60680-004	83143	60680004L	83143	HDR60680005	83142
60670-005	83137	60680-004L	83143	60680005	83142		

Chalmers Suspension

Chalmers Suspension	Gabriel	Chalmers Suspension	Gabriel	Chalmers Suspension	Gabriel	Chalmers Suspension	Gabriel
21335	G63355	800781	89425	K880248	89425		

Champion Bus Inc

Champion Bus Inc	Gabriel	Champion Bus Inc	Gabriel	Champion Bus Inc	Gabriel	Champion Bus Inc	Gabriel
22064230	83136	8C2Z-18124-D	G63622	ASH-1154	G63622	AT163G	G63622
8C24-18045-DA	G63622	8C2Z-18125-D	G63623	ASH1136	G63623	AT164G	G63623
8C24-18080-DB	G63623	8C2Z18124D	G63622	ASH1154	G63622		
8C2418045DA	G63622	8C2Z18125D	G63623	AT-163G	G63622		
8C2418080DB	G63623	ASH-1136	G63623	AT-164G	G63623		

Chance Coach

Chance Coach	Gabriel	Chance Coach	Gabriel	Chance Coach	Gabriel	Chance Coach	Gabriel
2021459	85012	2021459	89413				

Classic Industries Catalog

Classic Industries Catalog	Gabriel	Classic Industries Catalog	Gabriel	Classic Industries Catalog	Gabriel	Classic Industries Catalog	Gabriel
61500	61500	61635	61635	81340	81340	82035	82035
61506	61506	61641	61641	81342	81342	82047	82047
61516	61516	61642	61642	81394	81394	82065	82065
61517	61517	61646	61646	81484	81484	82066	82066
61518	61518	61654	61654	81490	81490	82086	82086
61519	61519	61655	61655	81496	81496	82155	82155
61520	61520	61656	61656	81510	81510	G56778	G56778
61521	61521	61663	61663	81667	81667	G57206	G57206
61522	61522	61680	61680	81668	81668	G57800	G57800
61523	61523	61682	61682	81676	81676	G57801	G57801
61524	61524	61683	61683	81710	81710	G57802	G57802
61525	61525	61684	61684	81713	81713	G57816	G57816
61530	61530	61685	61685	81726	81726	G63183	G63183
61542	61542	61687	61687	81744	81744	G63299	G63299
61543	61543	61710	61710	81821	81821	G63306	G63306
61544	61544	61713	61713	81825	81825	G63347	G63347
61546	61546	61714	61714	81828	81828	G63349	G63349
61547	61547	61716	61716	81834	81834	G63350	G63350
61554	61554	81039	81039	81873	81873	G63353	G63353
61555	61555	81082	81082	81919	81919	G63355	G63355
61565	61565	81091	81091	81920	81920	G63357	G63357
61591	61591	81096	81096	81921	81921	G63359	G63359
61592	61592	81113	81113	81925	81925	G63360	G63360
61599	61599	81147	81147	81928	81928	G63366	G63366
61600	61600	81164	81164	82003	82003		
61614	61614	81242	81242	82007	82007		
61632	61632	81270	81270	82012	82012		
61634	61634	81318	81318	82026	82026		

Important Note: Competitive Interchanges are to be used for stocking purposes only. Where multiple crosses are identified, please reference the applications section of this catalog. / **Remarque importante:** Les interchanges concurrentiels ne s'utilisent qu'aux fins de stocks. Dans le cas de références multiples, consulter la section des applications du catalogue. / **Nota importante:** Dans le cas de références multiples, consulter la section des applications du catalogue. / **Nota importante:** Se pueden usar intercambios competitivos para propósitos de almacenamiento solamente. Cuando se identifican intercambios múltiples, consulte la sección de aplicaciones de este catálogo.

COMPETITIVE & O.E.M. INTERCHANGE LIST
Lista de Intercambios contra Competidores y Equipo Original.
Liste d'interchange de produits compétitifs & déquippement original (OEM)

Classic Industries Catalog... cont'd

Classic Industries Catalog	Gabriel	Classic Industries Catalog	Gabriel	Classic Industries Catalog	Gabriel	Classic Industries Catalog	Gabriel
G63375	G63375	G63492	G63492	G63783	G63783	G64009	G64009
G63377	G63377	G63607	G63607	G63808	G63808	G64010	G64010
G63386	G63386	G63609	G63609	G63809	G63809	G64011	G64011
G63387	G63387	G63610	G63610	G63810	G63810	G64013	G64013
G63394	G63394	G63614	G63614	G63817	G63817	G64042	G64042
G63403	G63403	G63622	G63622	G63837	G63837	G64043	G64043
G63405	G63405	G63623	G63623	G63886	G63886	G64089	G64089
G63409	G63409	G63625	G63625	G63888	G63888	G64121	G64121
G63410	G63410	G63638	G63638	G63893	G63893	G64148	G64148
G63411	G63411	G63661	G63661	G63894	G63894	G64164	G64164
G63413	G63413	G63662	G63662	G63895	G63895	G64177	G64177
G63455	G63455	G63671	G63671	G63896	G63896	G64268	G64268
G63456	G63456	G63673	G63673	G63897	G63897	G64269	G64269
G63461	G63461	G63674	G63674	G63918	G63918		
G63488	G63488	G63675	G63675	G63969	G63969		
G63489	G63489	G63692	G63692	G63971	G63971		

CLV Warehouse INC

CLV Warehouse INC	Gabriel	CLV Warehouse INC	Gabriel	CLV Warehouse INC	Gabriel	CLV Warehouse INC	Gabriel
MON-65175	85084	MON-65468	85069				

CNH Global NV

CNH Global NV	Gabriel	CNH Global NV	Gabriel	CNH Global NV	Gabriel	CNH Global NV	Gabriel
87268250	83021						

Coach House

Coach House	Gabriel	Coach House	Gabriel	Coach House	Gabriel	Coach House	Gabriel
8C24-18045-DA	G63622	8C2Z-18124-D	G63622	ASH-1136	G63623	AT-163G	G63622
8C24-18080-DB	G63623	8C2Z-18125-D	G63623	ASH-1154	G63622	AT-164G	G63623
8C2418045DA	G63622	8C2Z18124D	G63622	ASH1136	G63623	AT163G	G63622
8C2418080DB	G63623	8C2Z18125D	G63623	ASH1154	G63622	AT164G	G63623

Coachmen

Coachmen	Gabriel	Coachmen	Gabriel	Coachmen	Gabriel	Coachmen	Gabriel
141700131809	85029	8C2Z-18124-D	G63622	ASH-1205	83209	ASH1205	83209
141700131810	83160	8C2Z-18125-D	G63623	ASH-1205	89414	ASH1205	89414
16-16736-000	85029	8C2Z18124D	G63622	ASH-1206	83122	ASH1206	83122
16-16737-000	83160	8C2Z18125D	G63623	ASH-1206	89406	ASH1206	89406
16-16873-000	85029	9U94-18045-AA	83209	ASH-1228	83209	ASH1228	83209
16-16874-000	83160	9U94-18045-AA	89414	ASH-1228	89414	ASH1228	89414
16-18103-000	85900	9U94-18080-AA	83122	ASH-1229	83209	ASH1229	83209
1616736000	85029	9U94-18080-AA	89406	ASH-1229	89414	ASH1229	89414
1616737000	83160	9U9418045AA	83209	ASH-1230	83122	ASH1230	83122
1616873000	85029	9U9418045AA	89414	ASH-1230	89406	ASH1230	89406
1616874000	83160	9U9418080AA	83122	ASH-137	83122	ASH137	83122
1618103000	85900	9U9418080AA	89406	ASH-137	89406	ASH137	89406
1C34-18045-AA	83209	9U9Z-18124-A	83209	ASH-25822	83209	ASH25822	83209
1C34-18045-AA	89414	9U9Z-18124-A	89414	ASH-25822	89414	ASH25822	89414
1C34-18045-JA	83209	9U9Z-18125-A	83122	ASH-25823	83209	ASH25823	83209
1C34-18045-JA	89414	9U9Z-18125-A	89406	ASH-25823	89414	ASH25823	89414
1C3418045AA	83209	9U9Z18124A	83209	ASH-25824	83122	ASH25824	83122
1C3418045AA	89414	9U9Z18124A	89414	ASH-25824	89406	ASH25824	89406
1C3418045JA	83209	9U9Z18125A	83122	ASH-294	83209	ASH294	83209
1C3418045JA	89414	9U9Z18125A	89406	ASH-294	89414	ASH294	89414
481700000490	85900	ASH-1022	83209	ASH1022	83209	AT-163G	G63622
481700000493	85900	ASH-1022	89414	ASH1022	89414	AT-164G	G63623
8C24-18045-DA	G63622	ASH-1023	83122	ASH1023	83122	AT-620	83209
8C24-18080-DB	G63623	ASH-1023	89406	ASH1023	89406	AT-620	89414
8C2418045DA	G63622	ASH-1136	G63623	ASH1136	G63623	AT-621	83122
8C2418080DB	G63623	ASH-1154	G63622	ASH1154	G63622	AT-621	89406

Important Note: Competitive Interchanges are to be used for stocking purposes only. Where multiple crosses are identified, please reference the applications section of this catalog. / **Remarque importante:** Les interchanges concurrentiels ne s'utilisent qu'aux fins de stocks. Dans le cas de références multiples, consulter la section des applications du catalogue. / **Nota importante:** Dans le cas de références multiples, consulter la section des applications du catalogue. / **Nota importante:** Se pueden usar intercambios competitivos para propósitos de almacenamiento solamente. Cuando se identifican intercambios múltiples, consulte la sección de aplicaciones de este catálogo.

COMPETITIVE & O.E.M. INTERCHANGE LIST
Lista de Intercambios contra Competidores y Equipo Original.
Liste d'interchange de produits compétitifs & équipement original (OEM)

Coachmen... cont'd

Coachmen	Gabriel	Coachmen	Gabriel	Coachmen	Gabriel	Coachmen	Gabriel
AT-766	83209	AT164G	G63623	AT621	83122	AT766	89414
AT-766	89414	AT620	83209	AT621	89406		
AT163G	G63622	AT620	89414	AT766	83209		

Cofap

Cofap	Gabriel	Cofap	Gabriel	Cofap	Gabriel	Cofap	Gabriel
45117	85918	ATG-085	G63607	L-12713	83136		
45117	89449	L-12703	85071				

Collins Bus Corp

Collins Bus Corp	Gabriel	Collins Bus Corp	Gabriel	Collins Bus Corp	Gabriel	Collins Bus Corp	Gabriel
ASH-1136	G63623	ASH-1154	G63622	ASH1136	G63623	ASH1154	G63622

Condumex

Condumex	Gabriel	Condumex	Gabriel	Condumex	Gabriel	Condumex	Gabriel
43066	83309	58034	85013	69500	83122	69745	85058
43139	83021	58034	89414	69500	89406	69745	89431
43145	83021	58041	83456	69669	83123	69746	83137
53010	83136	58041	89447	69669	89405	69750	89425
53018	83317	58048	83137	69671	85006	69753	85031
53019	83456	58056	83137	69672	85043	78001	89425
53019	89447	58057	83456	69673	83209	78015	85724
53039	85006	58057	89447	69673	89414	78015	89443
53040	85006	58058	85031	69685	83136	78023	85705
53042	83309	58059	85005	69705	83122	78023	89447
53043	83215	58059	89430	69705	89406	78025	85009
53063	83025	58061	83122	69712	85013	78027	89425
53065	83136	58061	89406	69712	89414	78039	85311
58012	89425	58061	89430	69729	89425	78039	89424

Country Coach

Country Coach	Gabriel	Country Coach	Gabriel	Country Coach	Gabriel	Country Coach	Gabriel
10-13634-000	85918	1618708000	89443	8C2418045DA	G63622	ASH-1154	G63622
10-13634-000	89449	471700000449	85918	8C2418080DB	G63623	ASH1136	G63623
1013634000	85918	471700000449	89449	8C2Z-18124-D	G63622	ASH1154	G63622
1013634000	89449	471700002809	85724	8C2Z-18125-D	G63623	AT-163G	G63622
16-18708-000	85724	471700002809	89443	8C2Z18124D	G63622	AT-164G	G63623
16-18708-000	89443	8C24-18045-DA	G63622	8C2Z18125D	G63623	AT163G	G63622
1618708000	85724	8C24-18080-DB	G63623	ASH-1136	G63623	AT164G	G63623

Crane Carrier

Crane Carrier	Gabriel	Crane Carrier	Gabriel	Crane Carrier	Gabriel	Crane Carrier	Gabriel
227A-14	85716	60680-004	83143	60680004	83143	64178-001	83143
227A14	85716	60680-004L	83143	60680004L	83143	64178001	83143

Cush Corporation

Cush Corporation	Gabriel	Cush Corporation	Gabriel	Cush Corporation	Gabriel	Cush Corporation	Gabriel
C0228	85005	C0228	89430				

Damon Motor Coach

Damon Motor Coach	Gabriel	Damon Motor Coach	Gabriel	Damon Motor Coach	Gabriel	Damon Motor Coach	Gabriel
1C34-18045-AA	83209	24186629	85125	9U9Z18124A	83209	ASH-1228	89414
1C34-18045-AA	89414	9U94-18045-AA	83209	9U9Z18124A	89414	ASH-1229	83209
1C34-18045-JA	83209	9U94-18045-AA	89414	9U9Z18125A	83122	ASH-1229	89414
1C34-18045-JA	89414	9U94-18080-AA	83122	9U9Z18125A	89406	ASH-1230	83122
1C3418045AA	83209	9U94-18080-AA	89406	ASH-1022	83209	ASH-1230	89406
1C3418045AA	89414	9U9418045AA	83209	ASH-1022	89414	ASH-137	83122
1C3418045JA	83209	9U9418045AA	89414	ASH-1023	83122	ASH-137	89406
1C3418045JA	89414	9U9418080AA	83122	ASH-1023	89406	ASH-25822	83209
24-153249	85125	9U9418080AA	89406	ASH-1205	83209	ASH-25822	89414
24-153256	85124	9U9Z-18124-A	83209	ASH-1205	89414		
24-186629	85125	9U9Z-18124-A	89414	ASH-1206	83122		
24153249	85125	9U9Z-18125-A	83122	ASH-1206	89406		
24153256	85124	9U9Z-18125-A	89406	ASH-1228	83209		

Important Note: Competitive Interchanges are to be used for stocking purposes only. Where multiple crosses are identified, please reference the applications section of this catalog. / **Remarque importante:** Les interchanges concurrentiels ne s'utilisent qu'aux fins de stocks. Dans le cas de références multiples, consulter la section des applications du catalogue. / **Nota importante:** Dans le cas de références multiples, consulter la section des applications du catalogue. / **Nota importante:** Se pueden usar intercambios competitivos para propósitos de almacenamiento solamente. Cuando se identifican intercambios múltiples, consulte la sección de aplicaciones de este catálogo.

COMPETITIVE & O.E.M. INTERCHANGE LIST

Lista de Intercambios contra Competidores y Equipo Original.

Liste d'interchange de produits compétitifs & déquippement original (OEM)

Damon Motor Coach... cont'd

Damon Motor Coach	Gabriel	Damon Motor Coach	Gabriel	Damon Motor Coach	Gabriel	Damon Motor Coach	Gabriel
ASH-25823	83209	ASH1228	83209	ASH294	83209	F4-BE5-A832-MO	85125
ASH-25823	89414	ASH1228	89414	ASH294	89414	F4-BE5-B492-HO	85125
ASH-25824	83122	ASH1229	83209	AT-620	83209	F4-BE5-F324-HO	85125
ASH-25824	89406	ASH1229	89414	AT-620	89414	F4-BE5-F325-HO	85124
ASH-294	83209	ASH1230	83122	AT-621	83122	F4BE5A832MO	85125
ASH-294	89414	ASH1230	89406	AT-621	89406	F4BE5B492HO	85125
ASH1022	83209	ASH137	83122	AT-766	83209	F4BE5F324HO	85125
ASH1022	89414	ASH137	89406	AT-766	89414	F4BE5F325HO	85124
ASH1023	83122	ASH25822	83209	AT620	83209	W0005662	85125
ASH1023	89406	ASH25822	89414	AT620	89414	W0005663	85124
ASH1205	83209	ASH25823	83209	AT621	83122	W0006254	85125
ASH1205	89414	ASH25823	89414	AT621	89406		
ASH1206	83122	ASH25824	83122	AT766	83209		
ASH1206	89406	ASH25824	89406	AT766	89414		

Dexter Axle

Dexter Axle	Gabriel	Dexter Axle	Gabriel	Dexter Axle	Gabriel	Dexter Axle	Gabriel
18165-01	85006	1816501	85006				

Diamond Coach

Diamond Coach	Gabriel	Diamond Coach	Gabriel	Diamond Coach	Gabriel	Diamond Coach	Gabriel
8C24-18045-DA	G63622	8C2Z-18124-D	G63622	ASH-1136	G63623	AT-163G	G63622
8C24-18080-DB	G63623	8C2Z-18125-D	G63623	ASH-1154	G63622	AT-164G	G63623
8C2418045DA	G63622	8C2Z18124D	G63622	ASH1136	G63623	AT163G	G63622
8C2418080DB	G63623	8C2Z18125D	G63623	ASH1154	G63622	AT164G	G63623

Dina Bus

Dina Bus	Gabriel	Dina Bus	Gabriel	Dina Bus	Gabriel	Dina Bus	Gabriel
13424S	83317	152C030010	83317	39390340-4	85716		
1520030010	83317	39380353-6	85716				

DriveTech

DriveTech	Gabriel	DriveTech	Gabriel	DriveTech	Gabriel	DriveTech	Gabriel
D344015	82066	D344081	81713	D344365	81873	D344383	81925
D344049	81490	D344085	81484	D344371	81828	D344386	81921
D344077	81082	D344087	81484	D344372	81928		
D344077	81510	D344266	81726	D344376	81919		
D344077	81710	D344267	81821	D344380	81920		

Dura Suspension

Dura Suspension	Gabriel	Dura Suspension	Gabriel	Dura Suspension	Gabriel	Dura Suspension	Gabriel
665267	85029	A-2212	85029	A2212	85029		

Dutchmen RV

Dutchmen RV	Gabriel	Dutchmen RV	Gabriel	Dutchmen RV	Gabriel	Dutchmen RV	Gabriel
8C24-18045-DA	G63622	8C2Z-18124-D	G63622	ASH-1136	G63623	AT-163G	G63622
8C24-18080-DB	G63623	8C2Z-18125-D	G63623	ASH-1154	G63622	AT-164G	G63623
8C2418045DA	G63622	8C2Z18124D	G63622	ASH1136	G63623	AT163G	G63622
8C2418080DB	G63623	8C2Z18125D	G63623	ASH1154	G63622	AT164G	G63623

Dynamax Corp

Dynamax Corp	Gabriel	Dynamax Corp	Gabriel	Dynamax Corp	Gabriel	Dynamax Corp	Gabriel
10-13021-000	85918	1013021000	89449	16-18708-000	85724	471700002808	89443
10-13021-000	89449	1013063000	85918	16-18708-000	89443	471700002809	85724
10-13063-000	85918	1013063000	89449	1615817000	85724	471700002809	89443
10-13063-000	89449	1013211000	85918	1615817000	89443	471700002810	85724
10-13211-000	85918	1013211000	89449	1618708000	85724	471700002810	89443
10-13211-000	89449	1013634000	85918	1618708000	89443	471700131155	85918
10-13634-000	85918	1013634000	89449	471700000449	85918	471700131155	89449
10-13634-000	89449	1013684000	85918	471700000449	89449	481700006848	85724
10-13684-000	85918	1013684000	89449	471700000450	85918	481700006848	89443
10-13684-000	89449	16-15817-000	85724	471700000450	89449	680611	85724
1013021000	85918	16-15817-000	89443	471700002808	85724	680611	89443

Important Note: Competitive Interchanges are to be used for stocking purposes only. Where multiple crosses are identified, please reference the applications section of this catalog. / **Remarque importante:** Les interchanges concurrentiels ne s'utilisent qu'aux fins de stocks. Dans le cas de références multiples, consulter la section des applications du catalogue. / **Nota importante:** Dans le cas de referencias multiples, consultar la sección de aplicaciones del catálogo. / **Nota importante:** Se pueden usar intercambios competitivos para propósitos de almacenamiento solamente. Cuando se identifican intercambios múltiples, consulte la sección de aplicaciones de este catálogo.

COMPETITIVE & O.E.M. INTERCHANGE LIST
Lista de Intercambios contra Competidores y Equipo Original.
Liste d'interchange de produits compétitifs & équipement original (OEM)

Dynamax Corp... cont'd

Dynamax Corp	Gabriel	Dynamax Corp	Gabriel	Dynamax Corp	Gabriel	Dynamax Corp	Gabriel
8C24-18045-DA	G63622	8C2Z-18125-D	G63623	ASH1136	G63623	AT164G	G63623
8C24-18080-DB	G63623	8C2Z18124D	G63622	ASH1154	G63622	SDA471700002809	85724
8C2418045DA	G63622	8C2Z18125D	G63623	AT-163G	G63622	SDA471700002809	89443
8C2418080DB	G63623	ASH-1136	G63623	AT-164G	G63623		
8C2Z-18124-D	G63622	ASH-1154	G63622	AT163G	G63622		

E-One

E-One	Gabriel	E-One	Gabriel	E-One	Gabriel	E-One	Gabriel
ASH-1136	G63623	ASH-1154	G63622	ASH1136	G63623	ASH1154	G63622

Eagle Motor Coach

Eagle Motor Coach	Gabriel	Eagle Motor Coach	Gabriel	Eagle Motor Coach	Gabriel	Eagle Motor Coach	Gabriel
154-0100-514	89425	1540100514	89425				

East Manufacturing Corp

East Manufacturing Corp	Gabriel	East Manufacturing Corp	Gabriel	East Manufacturing Corp	Gabriel	East Manufacturing Corp	Gabriel
517-05001-23	85005	517-05806-20	85029	5170500123	89430		
517-05001-23	89430	5170500123	85005	5170580620	85029		

Eldorado National

Eldorado National	Gabriel	Eldorado National	Gabriel	Eldorado National	Gabriel	Eldorado National	Gabriel
8C24-18045-DA	G63622	8C2Z-18124-D	G63622	ASH-1136	G63623	AT-163G	G63622
8C24-18080-DB	G63623	8C2Z-18125-D	G63623	ASH-1154	G63622	AT-164G	G63623
8C2418045DA	G63622	8C2Z18124D	G63622	ASH1136	G63623	AT163G	G63622
8C2418080DB	G63623	8C2Z18125D	G63623	ASH1154	G63622	AT164G	G63623

Entegra Coach

Entegra Coach	Gabriel	Entegra Coach	Gabriel	Entegra Coach	Gabriel	Entegra Coach	Gabriel
10-13976-000	85918	9U9418080AA	83122	ASH-137	89406	ASH1230	89406
10-13976-000	89449	9U9418080AA	89406	ASH-25820	85005	ASH137	83122
1013976000	85918	9U9Z-18124-A	83209	ASH-25820	89430	ASH137	89406
1013976000	89449	9U9Z-18124-A	89414	ASH-25821	85006	ASH25820	85005
16-16764-000	85724	9U9Z-18125-A	83122	ASH-25822	83209	ASH25820	89430
16-16764-000	89443	9U9Z-18125-A	89406	ASH-25822	89414	ASH25821	85006
1616764000	85724	9U9Z18124A	83209	ASH-25823	83209	ASH25822	83209
1616764000	89443	9U9Z18124A	89414	ASH-25823	89414	ASH25822	89414
1C34-18045-AA	83209	9U9Z18125A	83122	ASH-25824	83122	ASH25823	83209
1C34-18045-AA	89414	9U9Z18125A	89406	ASH-25824	89406	ASH25823	89414
1C34-18045-JA	83209	ASH-1022	83209	ASH-294	83209	ASH25824	83122
1C34-18045-JA	89414	ASH-1022	89414	ASH-294	89414	ASH25824	89406
1C3418045AA	83209	ASH-1023	83122	ASH1022	83209	ASH294	83209
1C3418045AA	89414	ASH-1023	89406	ASH1022	89414	ASH294	89414
1C3418045JA	83209	ASH-1136	G63623	ASH1023	83122	AT-163G	G63622
1C3418045JA	89414	ASH-1154	G63622	ASH1023	89406	AT-164G	G63623
8C24-18045-DA	G63622	ASH-1161	85006	ASH1136	G63623	AT-620	83209
8C24-18080-DB	G63623	ASH-1162	85005	ASH1154	G63622	AT-620	89414
8C2418045DA	G63622	ASH-1162	89430	ASH1161	85006	AT-621	83122
8C2418080DB	G63623	ASH-1205	83209	ASH1162	85005	AT-621	89406
8C2Z-18124-D	G63622	ASH-1205	89414	ASH1162	89430	AT-766	83209
8C2Z-18125-D	G63623	ASH-1206	83122	ASH1205	83209	AT-766	89414
8C2Z18124D	G63622	ASH-1206	89406	ASH1205	89414	AT163G	G63622
8C2Z18125D	G63623	ASH-1228	83209	ASH1206	83122	AT164G	G63623
9U94-18045-AA	83209	ASH-1228	89414	ASH1206	89406	AT620	83209
9U94-18045-AA	89414	ASH-1229	83209	ASH1228	83209	AT620	89414
9U94-18080-AA	83122	ASH-1229	89414	ASH1228	89414	AT621	83122
9U94-18080-AA	89406	ASH-1230	83122	ASH1229	83209	AT621	89406
9U9418045AA	83209	ASH-1230	89406	ASH1229	89414	AT766	83209
9U9418045AA	89414	ASH-137	83122	ASH1230	83122	AT766	89414

Euclid

Euclid	Gabriel	Euclid	Gabriel	Euclid	Gabriel	Euclid	Gabriel
E14045	83143	E83205	83209				
E14046	83142	E83205	89414				

Important Note: Competitive Interchanges are to be used for stocking purposes only. Where multiple crosses are identified, please reference the applications section of this catalog. / **Remarque importante:** Les interchanges concurrentiels ne s'utilisent qu'aux fins de stocks. Dans le cas de références multiples, consulter la section des applications du catalogue. / **Nota importante:** Dans le cas de références multiples, consulter la section des applications du catalogue. / **Nota importante:** Se pueden usar intercambios competitivos para propósitos de almacenamiento solamente. Cuando se identifican intercambios múltiples, consulte la sección de aplicaciones de este catálogo.

COMPETITIVE & O.E.M. INTERCHANGE LIST
Lista de Intercambios contra Competidores y Equipo Original.
Liste d'interchange de produits compétitifs & déquippement original (OEM)

Euclid... cont'd

Euclid	Gabriel	Euclid	Gabriel	Euclid	Gabriel	Euclid	Gabriel
E83209	83209	E83308	83308	E85006	85006	E85311	89424
E83209	89414	E83309	83309	E85010	85010	E85314	89425
E83215	83215	E83310	83221	E85012	85012	E85705	85705
E83216	83216	E83312	83312	E85012	89413	E85705	89447
E83218	83122	E83312	89409	E85013	85013	E87012	85705
E83218	89406	E83314	83314	E85013	89414	E87012	89447
E83221	83221	E85005	85005	E85029	85029		
E83225	83225	E85005	89430	E85311	85311		

FCS

FCS	Gabriel	FCS	Gabriel	FCS	Gabriel	FCS	Gabriel
1331821	G57206	342496	81821	F344353	83142	F347261	85918
1333919L	G57852	342501	81082	F344355	83143	F347261	89449
1333919R	G57853	342501	81510	F344356	83154	F347269	85013
1337023L	G57800	342501	81710	F346599	85311	F347269	89414
1337023R	G57801	342502	G63809	F346599	89424	F347270	85005
2331821	G57206	342509	G63810	F346632	83317	F347270	89430
331700	G56778	342510	G63808	F346633	85988	F347272	85932
3331821L	G57206	342511	G63810	F346634	83515	F347272	89453
3331821R	G57206	342512	81710	F346635	83518	F347274	85956
341511	81668	342527	81873	F346636	83395	F347276	89458
341512	81713	342529	81921	F346637	85649	F347277	83148
341514	81490	342534	G63918	F347198	85058	F347280	85010
341520	82155	342549	81676	F347198	89431	F347296	83006
341568	81744	342549	82007	F347200	85072	F347300	85989
341574	G63410	342565	81873	F347203	83127	F347302	85656
341575	81713	342567	81496	F347206	85029	F347304	83163
341576	81744	342770	G64042	F347213	89458	F347307	89405
341577	81744	342780	81484	F347219	85006	F347309	83122
341580	G63886	342781	81113	F347222	83021	F347309	89406
341582	81828	342790	G63886	F347224	85919	F347310	85031
341594	G63894	342827	G63622	F347226	85012	F347313	83140
341596	G63895	342838	81676	F347226	89413	F347315	83126
341597	81920	342846	G64121	F347235	85978	F347315	89430
341598	81925	342848	G64148	F347236	83137	F347317	83166
341599	81920	343308	81270	F347238	85331	F347319	83221
341639	81928	347037	G63888	F347239	85976	F347319	85071
341641	81919	4331821L	G57206	F347241	85928	F347323	83101
341643	G64011	4331821R	G57206	F347242	85957	F347325	83312
341645	81096	5331821L	G57206	F347243	83209	F347325	89409
342129	G63299	5331821R	G57206	F347243	89414	F347331	89430
342462	81726	DT347071	77412	F347244	85043	F347333	83215
342466	81667	F343368	85069	F347247	83135	F347337	83309
342467	81039	F343368	89455	F347248	83123	F347342	83169
342467	81496	F343372	83136	F347248	89405	F347346	85642
342478	81318	F343373	83456	F347249	85084	F347347	83519
342480	81147	F343373	89447	F347249	89460	F347348	83391
342486	81147	F343376	85900	F347253	83025	F347353	83364
342487	82066	F343378	85902	F347260	85724	F347356	85650
342493	81318	F343382	83613	F347260	89443		

Federal Coach

Federal Coach	Gabriel	Federal Coach	Gabriel	Federal Coach	Gabriel	Federal Coach	Gabriel
16-18708-000	85724	1618708000	89443	471700002810	85724	ASH-1154	G63622
16-18708-000	89443	471700002809	85724	471700002810	89443	ASH1136	G63623
1618708000	85724	471700002809	89443	ASH-1136	G63623	ASH1154	G63622

Important Note: Competitive Interchanges are to be used for stocking purposes only. Where multiple crosses are identified, please reference the applications section of this catalog. / **Remarque importante:** Les interchanges concurrentiels ne s'utilisent qu'aux fins de stocks. Dans le cas de références multiples, consulter la section des applications du catalogue. / **Nota importante:** Dans le cas de références multiples, consulter la section des applications du catalogue. / **Nota importante:** Se pueden usar intercambios competitivos para propósitos de almacenamiento solamente. Cuando se identifican intercambios múltiples, consulte la sección de aplicaciones de este catálogo.

COMPETITIVE & O.E.M. INTERCHANGE LIST
Lista de Intercambios contra Competidores y Equipo Original.
Liste d'interchange de produits compétitifs & équipement original (OEM)

Fleetrite

Fleetrite	Gabriel	Fleetrite	Gabriel	Fleetrite	Gabriel	Fleetrite	Gabriel
AMS600102	85005	AMS650113	85012	AMS65144	85957	AMS660187	85071
AMS600102	89430	AMS650113	89413	AMS660102	85005	AMS660189	83136
AMS600106	83312	AMS650114	85006	AMS660102	89430	AMS660191	83216
AMS600106	89409	AMS650118	83215	AMS660106	83312	AMS660196	G63610
AMS600107	83309	AMS650119	85029	AMS660106	89409	AMS660201	83308
AMS600108	83209	AMS650120	85010	AMS660107	83309	AMS660213	85009
AMS600108	89414	AMS650128	85031	AMS660108	83209	AMS660216	83123
AMS600112	83456	AMS650139	85918	AMS660108	89414	AMS660216	89405
AMS600112	89447	AMS650139	89449	AMS660112	83456	AMS660218	83137
AMS600113	83215	AMS650401	85013	AMS660112	89447	AMS660219	83215
AMS600116	83216	AMS650401	89414	AMS660113	83215	AMS660232	83114
AMS600117	83308	AMS650402	85311	AMS660114	85006	AMS660236	83025
AMS600119	83314	AMS650402	89424	AMS660116	83216	AMS660238	83101
AMS600123	G63183	AMS650411	89405	AMS660117	83308	AMS700105	89425
AMS600125	83123	AMS650412	83122	AMS660118	85012	AMS700116	83136
AMS600125	89405	AMS650412	89406	AMS660118	89413	AMS700120	85332
AMS600129	83317	AMS650420	85013	AMS660119	83314	AMS700121	83136
AMS600132	83215	AMS650420	89414	AMS660123	G63183	AMS700404	85311
AMS600134	83221	AMS650421	89430	AMS660125	83123	AMS700404	89424
AMS600142	83209	AMS650434	85012	AMS660125	89405	AMS700410	89425
AMS600142	89414	AMS650434	89413	AMS660129	83317	AMS700413	85705
AMS600147	83216	AMS650436	85900	AMS660132	83215	AMS700413	89447
AMS600150	85009	AMS650444	85311	AMS660134	83221	AMS700423	85724
AMS600155	83103	AMS650444	89424	AMS660142	83209	AMS700423	89443
AMS600156	83103	AMS650451	85029	AMS660142	89414	AMS85736	G63394
AMS600157	83221	AMS650453	85043	AMS660147	83216	AMS85768	83209
AMS600162	83103	AMS650455	85716	AMS660155	83103	AMS85768	89414
AMS600163	83101	AMS650459	85043	AMS660160	83114	AMS85802	83216
AMS600164	83613	AMS650464	85716	AMS660161	G63610	AMS85803	G63306
AMS600172	85005	AMS650468	85069	AMS660162	83103	AMS85853	G63183
AMS600172	89430	AMS650468	89455	AMS660164	83613	AMS85900	G63386
AMS600173	85043	AMS650479	83122	AMS660172	83126	AMS85901	G63387
AMS600175	83120	AMS650479	89406	AMS660172	89430	AMS85904	G63299
AMS650109	85058	AMS650481	83123	AMS660173	85043	AMS85905	G63405
AMS650109	89431	AMS650481	89405	AMS660175	83120	AMS85960	G63366
AMS650110	85005	AMS650482	85006	AMS660179	83162		
AMS650110	89430	AMS65109	85058	AMS660183	85012		
AMS650111	85006	AMS65109	89431	AMS660183	89413		

Fleetwood

Fleetwood	Gabriel	Fleetwood	Gabriel	Fleetwood	Gabriel	Fleetwood	Gabriel
141700131809	85029	1C3418045AA	89414	9U94-18080-AA	83122	ASH-1023	89406
141700131810	83160	1C3418045JA	83209	9U94-18080-AA	89406	ASH-1136	G63623
16-16736-000	85029	1C3418045JA	89414	9U9418045AA	83209	ASH-1154	G63622
16-16737-000	83160	24-153256	85124	9U9418045AA	89414	ASH-1161	85006
16-16873-000	85029	24153256	85124	9U9418080AA	83122	ASH-1162	85005
16-16874-000	83160	481700000490	85900	9U9418080AA	89406	ASH-1162	89430
16-18103-000	85900	481700000493	85900	9U9Z-18124-A	83209	ASH-1205	83209
1616736000	85029	8C24-18045-DA	G63622	9U9Z-18124-A	89414	ASH-1205	89414
1616737000	83160	8C24-18080-DB	G63623	9U9Z-18125-A	83122	ASH-1206	83122
1616873000	85029	8C2418045DA	G63622	9U9Z-18125-A	89406	ASH-1206	89406
1616874000	83160	8C2418080DB	G63623	9U9Z18124A	83209	ASH-1228	83209
1618103000	85900	8C2Z-18124-D	G63622	9U9Z18124A	89414	ASH-1228	89414
1C34-18045-AA	83209	8C2Z-18125-D	G63623	9U9Z18125A	83122	ASH-1229	83209
1C34-18045-AA	89414	8C2Z18124D	G63622	9U9Z18125A	89406		
1C34-18045-JA	83209	8C2Z18125D	G63623	ASH-1022	83209		
1C34-18045-JA	89414	9U94-18045-AA	83209	ASH-1022	89414		
1C3418045AA	83209	9U94-18045-AA	89414	ASH-1023	83122		

Important Note: Competitive Interchanges are to be used for stocking purposes only. Where multiple crosses are identified, please reference the applications section of this catalog. / **Remarque importante:** Les interchanges concurrentiels ne s'utilisent qu'aux fins de stocks. Dans le cas de références multiples, consulter la section des applications du catalogue. / **Nota importante:** Dans le cas de références multiples, consulter la section des applications du catalogue. / **Nota importante:** Se pueden usar intercambios competitivos para propósitos de almacenamiento solamente. Cuando se identifican intercambios múltiples, consulte la sección de aplicaciones de este catálogo.

COMPETITIVE & O.E.M. INTERCHANGE LIST
Lista de Intercambios contra Competidores y Equipo Original.
Liste d'interchange de produits compétitifs & déquippement original (OEM)

Fleetwood... cont'd

Fleetwood	Gabriel	Fleetwood	Gabriel	Fleetwood	Gabriel	Fleetwood	Gabriel
ASH-1229	89414	ASH1022	89414	ASH1230	89406	AT-620	89414
ASH-1230	83122	ASH1023	83122	ASH137	83122	AT-621	83122
ASH-1230	89406	ASH1023	89406	ASH137	89406	AT-621	89406
ASH-137	83122	ASH1136	G63623	ASH25820	85005	AT-766	83209
ASH-137	89406	ASH1154	G63622	ASH25820	89430	AT-766	89414
ASH-25820	85005	ASH1161	85006	ASH25821	85006	AT163G	G63622
ASH-25820	89430	ASH1162	85005	ASH25822	83209	AT164G	G63623
ASH-25821	85006	ASH1162	89430	ASH25822	89414	AT620	83209
ASH-25822	83209	ASH1205	83209	ASH25823	83209	AT620	89414
ASH-25822	89414	ASH1205	89414	ASH25823	89414	AT621	83122
ASH-25823	83209	ASH1206	83122	ASH25824	83122	AT621	89406
ASH-25823	89414	ASH1206	89406	ASH25824	89406	AT766	83209
ASH-25824	83122	ASH1228	83209	ASH294	83209	AT766	89414
ASH-25824	89406	ASH1228	89414	ASH294	89414	F4-BE5-F325-HO	85124
ASH-294	83209	ASH1229	83209	AT-163G	G63622	F4BE5F325HO	85124
ASH-294	89414	ASH1229	89414	AT-164G	G63623	W0005663	85124
ASH1022	83209	ASH1230	83122	AT-620	83209		

FLXIBLE Bus

FLXIBLE Bus	Gabriel	FLXIBLE Bus	Gabriel	FLXIBLE Bus	Gabriel	FLXIBLE Bus	Gabriel
97-2210-00160	85705	97-9999-02633	89424	97221000160	89447	97999902636	85716
97-2210-00160	89447	97-9999-02636	85716	97999902633	85311		
97-9999-02633	85311	97221000160	85705	97999902633	89424		

Ford

Ford	Gabriel	Ford	Gabriel	Ford	Gabriel	Ford	Gabriel
1201-1043	83025	3578858C2	85656	47902-8	83122	4C4O18080BA	83317
1201-1044	83025	3584116C1	83175	47902-8	89406	4C4Z-18124-AB	83163
12011043	83025	3584116C2	83175	4790213	83122	4C4Z-18124-BB	83135
12011044	83025	3584117C2	83135	4790213	89406	4C4Z-18124-CB	85957
1202-0042	83025	3584118C2	85928	4790228	85013	4C4Z-18124-DC	85927
1202-1043	83025	3U2Z-18124-BAA	G63809	4790228	89414	4C4Z-18124-EA	85656
1202-1044	83025	3U2Z-18124-BV	G63614	479028	83122	4C4Z-18124-GB	83175
12020042	83025	3U2Z-18124-BW	G63614	479028	89406	4C4Z-18124-HB	83135
12021043	83025	3U2Z-18124-FAA	G63809	4C4O-18045-AA	83163	4C4Z-18124-JB	85928
12021044	83025	3U2Z-18124-JAA	G63614	4C4O-18045-BB	83135	4C4Z-18124-KA	85976
1C34-18045-AA	83209	3U2Z-18124-MAA	83131	4C4O-18045-CA	85957	4C4Z-18124-LA	85976
1C34-18045-AA	89414	3U2Z-18124-YAA	G63809	4C4O-18045-DB	85927	4C4Z-18124-M	85656
1C34-18045-JA	83209	3U2Z-18125-CA	G63607	4C4O-18045-EA	85656	4C4Z-18124-P	83135
1C34-18045-JA	89414	3U2Z-18125-RA	G63623	4C4O-18045-GA	83175	4C4Z-18124-QA	83175
1C3418045AA	83209	3U2Z18124BAA	G63809	4C4O-18045-HA	83135	4C4Z-18124-RA	85928
1C3418045AA	89414	3U2Z18124BV	G63614	4C4O-18045-JA	85928	4C4Z-18125-AB	83101
1C3418045JA	83209	3U2Z18124BW	G63614	4C4O-18045-KA	85976	4C4Z-18125-B	83317
1C3418045JA	89414	3U2Z18124FAA	G63809	4C4O-18045-LA	85976	4C4Z-18125-CA	85976
1C44-18080-AA	83123	3U2Z18124JAA	G63614	4C4O-18045-MA	85656	4C4Z-18125-DA	85656
1C44-18080-AA	89405	3U2Z18124MAA	83131	4C4O-18080-AA	83101	4C4Z18124AB	83163
1C4418080AA	83123	3U2Z18124YAA	G63809	4C4O-18080-BA	83317	4C4Z18124BB	83135
1C4418080AA	89405	3U2Z18125CA	G63607	4C4O18045AA	83163	4C4Z18124CB	85957
2C44-18045-BA	83175	3U2Z18125RA	G63623	4C4O18045BB	83135	4C4Z18124DC	85927
2C4418045BA	83175	47 1700 007 203	85013	4C4O18045CA	85957	4C4Z18124EA	85656
2C4Z-18124-BA	83175	47 1700 007 203	89414	4C4O18045DB	85927	4C4Z18124GB	83175
2C4Z18124BA	83175	471700007117	85010	4C4O18045EA	85656	4C4Z18124HB	83135
2C7Z-18125-AA	G63837	471700009775	85010	4C4O18045GA	83175	4C4Z18124JB	85928
2C7Z-18125-CA	G63607	471700011530	85181	4C4O18045HA	83135	4C4Z18124KA	85976
2C7Z18125AA	G63837	471700011531	85180	4C4O18045JA	85928	4C4Z18124LA	85976
2C7Z18125CA	G63607	47902-13	83122	4C4O18045KA	85976		
3553628C1	85927	47902-13	89406	4C4O18045LA	85976		
3553628C2	85927	47902-28	85013	4C4O18045MA	85656		
3578858C1	85656	47902-28	89414	4C4O18080AA	83101		

Important Note: Competitive Interchanges are to be used for stocking purposes only. Where multiple crosses are identified, please reference the applications section of this catalog. / **Remarque importante:** Les interchanges concurrentiels ne s'utilisent qu'aux fins de stocks. Dans le cas de références multiples, consulter la section des applications du catalogue. / **Nota importante:** Dans le cas de références multiples, consulter la section des applications du catalogue. / **Nota importante:** Se pueden usar intercambios competitivos para propósitos de almacenamiento solamente. Cuando se identifican intercambios múltiples, consulte la sección de aplicaciones de este catálogo.

COMPETITIVE & O.E.M. INTERCHANGE LIST
Lista de Intercambios contra Competidores y Equipo Original.
Liste d'interchange de produits compétitifs & déquippement original (OEM)

Ford... cont'd

Ford	Gabriel	Ford	Gabriel	Ford	Gabriel	Ford	Gabriel
4C4Z18124M	85656	6E7O-18B038-AA	83364	9U9418045AA	89414	ASH-24446	83215
4C4Z18124P	83135	6E7O18B038AA	83364	9U9418080AA	83122	ASH-2447	83140
4C4Z18124QA	83175	6E7Z-18124-AB	83364	9U9418080AA	89406	ASH-24473	85013
4C4Z18124RA	85928	6E7Z18124AB	83364	9U9Z-18124-A	83209	ASH-24473	89414
4C4Z18125AB	83101	6ETZ-18125-A	83364	9U9Z-18124-A	89414	ASH-24474	85010
4C4Z18125B	83317	6ETZ18125A	83364	9U9Z-18125-A	83122	ASH-24522	85013
4C4Z18125CA	85976	6U2Z-18V125-A	G63837	9U9Z-18125-A	89406	ASH-24522	89414
4C4Z18125DA	85656	6U2Z-18V125-B	G63607	9U9Z-18125-B	83122	ASH-24523	85010
501906C91	83317	6U2Z18V125A	G63837	9U9Z-18125-B	89406	ASH-24589	85010
501906C92	83317	6U2Z18V125B	G63607	9U9Z18124A	83209	ASH-24634	85013
57365-111	85006	70127	85006	9U9Z18124A	89414	ASH-24634	89414
57365111	85006	70128	85006	9U9Z18124B	83209	ASH-24658	85181
5C3Z-18124-JA	G63969	7C2Z-18125-D	G63623	9U9Z18124B	89414	ASH-24659	85181
5C3Z-18125-CF	77969	7C34-18045-HB	G63969	9U9Z18125A	83122	ASH-24660	85180
5C3Z-18125-DA	77968	7C34-18080-DCB	77968	9U9Z18125A	89406	ASH-24661	83317
5C3Z18124JA	G63969	7C3418045HB	G63969	9U9Z18125B	83122	ASH-24662	83168
5C3Z18125CF	77969	7C3418080DCB	77968	9U9Z18125B	89406	ASH-24663	83148
5C3Z18125DA	77968	7C3Z 18124-NCA	G63886	AA-494	83131	ASH-247	G63461
5U2Z-18V124-AHA	G63622	7C3Z 18124-NDA	G63886	AA-615	83135	ASH-25770	77987
5U2Z-18V124-CAA	G63809	7C3Z 18124-NEA	G63886	AA-616	83175	ASH-25820	85005
5U2Z-18V124-DB	G63455	7C3Z 18124-PBA	G63886	AA-617	85928	ASH-25820	89430
5U2Z-18V124-GA	G63809	7C3Z 18124-PCA	G63886	AA-619	85927	ASH-25821	85006
5U2Z-18V125-AE	G63808	7C3Z 18125-JCA	G63888	AA-620	83101	ASH-25822	83209
5U2Z-18V125-AF	G63810	7C3Z 18125-JEA	G63888	AA494	83131	ASH-25822	89414
5U2Z-18V125-BDA	G63623	7C3Z 18125-KBA	G63888	AA615	83135	ASH-25823	83209
5U2Z-18V125-BS	G63607	7C3Z 18125-KCA	G63888	AA616	83175	ASH-25823	89414
5U2Z-18V125-G	G63837	7C3Z 18125-KDA	G63888	AA617	85928	ASH-25824	83122
5U2Z-3V651-C	6828SE	7C3Z-18124-NJA	G63886	AA619	85927	ASH-25824	89406
5U2Z18V124AHA	G63622	7C3Z-18125-CXA	G64010	AA620	83101	ASH-25838	85978
5U2Z18V124CAA	G63809	8C24-18045-DA	G63622	ASH-1022	83209	ASH-294	83209
5U2Z18V124DB	G63455	8C24-18080-DB	G63623	ASH-1022	89414	ASH-294	89414
5U2Z18V124GA	G63809	8C2418045DA	G63622	ASH-1023	83122	ASH-397	83131
5U2Z18V125AE	G63808	8C2418045DA	G63625	ASH-1023	89406	ASH-722	85976
5U2Z18V125AF	G63810	8C2418080DB	G63623	ASH-1105	85976	ASH-85789	77986
5U2Z18V125BDA	G63623	8C2Z 18124-B	G63622	ASH-1136	G63623	ASH-85856	77987
5U2Z18V125BS	G63607	8C2Z 18124-C	G63622	ASH-1154	G63622	ASH-85857	77987
5U2Z18V125G	G63837	8C2Z 18125-D	G63623	ASH-1161	85006	ASH-85927	77986
60670-008	83123	8C2Z-18124-A	G63622	ASH-1162	85005	ASH-866127	77986
60670-008	89405	8C2Z-18124-D	G63622	ASH-1162	89430	ASH-866139	77986
60670-008L	83123	8C2Z-18125-A	G63623	ASH-1205	83209	ASH1022	83209
60670-008L	89405	8C2Z-18125-B	G63623	ASH-1205	89414	ASH1022	89414
60670-011	83148	8C2Z-18125-C	G63623	ASH-1206	83122	ASH1023	83122
60670-012	83168	8C2Z-18125-D	G63623	ASH-1206	89406	ASH1023	89406
60670008	83123	8C2Z18124D	G63622	ASH-12251	85013	ASH1105	85976
60670008	89405	8C2Z18125A	G63623	ASH-12251	89414	ASH1136	G63623
60670008L	83123	8C2Z18125B	G63623	ASH-12261	85010	ASH1154	G63622
60670008L	89405	8C2Z18125C	G63623	ASH-1228	83209	ASH1161	85006
60670011	83148	8C2Z18125D	G63623	ASH-1228	89414	ASH1162	85005
60670012	83168	8C3Z-3E651-E	14072	ASH-1229	83209	ASH1162	89430
60675-003	85976	9C3Z 18124-A	G63886	ASH-1229	89414	ASH1205	83209
60675-003L	85976	9C3Z 18125-A	G63888	ASH-1230	83122	ASH1205	89414
60675-014	85978	9U94-18045-AA	83209	ASH-1230	89406	ASH1206	83122
60675003	85976	9U94-18045-AA	89414	ASH-137	83122	ASH1206	89406
60675003L	85976	9U94-18080-AA	83122	ASH-137	89406	ASH12251	85013
60675014	85978	9U94-18080-AA	89406	ASH-23486	G63461	ASH12251	89414
6C2Z-18124-A	G63622	9U9418045AA	83209	ASH-23488	G63461	ASH12261	85010

Important Note: Competitive Interchanges are to be used for stocking purposes only. Where multiple crosses are identified, please reference the applications section of this catalog. / **Remarque importante:** Les interchanges concurrentiels ne s'utilisent qu'aux fins de stocks. Dans le cas de références multiples, consulter la section des applications du catalogue. / **Nota importante:** Dans le cas de références multiples, consulter la section des applications du catalogue. / **Nota importante:** Se pueden usar intercambios competitivos para propósitos de almacenamiento solamente. Cuando se identifican intercambios múltiples, consulte la sección de aplicaciones de este catálogo.

COMPETITIVE & O.E.M. INTERCHANGE LIST
Lista de Intercambios contra Competidores y Equipo Original.
Liste d'interchange de produits compétitifs & déquippement original (OEM)

Ford... cont'd

Ford	Gabriel	Ford	Gabriel	Ford	Gabriel	Ford	Gabriel
ASH1228	83209	AT164G	G63623	BC3Z-18124-G	G63886	C2TA18045A	83216
ASH1228	89414	AT610	G63461	BC3Z-18125-AA	G64010	C2TA18045B	83308
ASH1229	83209	AT611	G63461	BC3Z-18125-AJ	G63888	C2TZ-18124-A	83308
ASH1229	89414	AT620	83209	BC3Z-18125-AN	G64010	C2TZ18124A	83308
ASH1230	83122	AT620	89414	BC3Z-18125-AP	77969	C3TA-18045-A	83216
ASH1230	89406	AT621	83122	BC3Z-18125-AQ	77969	C3TA18045A	83216
ASH137	83122	AT621	89406	BC3Z-18125-F	61682	C3TZ-18124-A	83308
ASH137	89406	AT696	83140	BC3Z-18125-V	G63888	C3TZ18124A	83308
ASH23486	G63461	AT766	83209	BK3Z-18124-A	G57816	C4HZ-18124-A	83312
ASH23488	G63461	AT766	89414	BU2Z-18V125-F	G64010	C4HZ-18124-A	89409
ASH24446	83215	AT811	83135	BU9Z-18124-A	85013	C4HZ-18124-B	83309
ASH2447	83140	AT812	85928	BU9Z-18124-A	89414	C4HZ-18124-C	83314
ASH24473	85013	AU2Z-18V124-AC	G63886	BU9Z-18125-A	85010	C4HZ-18124-D	83312
ASH24473	89414	AU2Z-18V124-AU	G63622	BU9Z18124A	85013	C4HZ-18124-D	89409
ASH24474	85010	AU2Z-18V124-J	G63886	BU9Z18124A	89414	C4HZ-18124-E	83309
ASH24522	85013	AU2Z-18V125-S	G63888	BU9Z18125A	85010	C4HZ-18124-F	83308
ASH24522	89414	AX-267A	83309	C0TT-18045-D	83216	C4HZ18124A	83312
ASH24589	85010	AX-310	83215	C0TT18045D	83216	C4HZ18124A	89409
ASH24634	85013	AX267A	83309	C0TZ-18124-A	83216	C4HZ18124B	83309
ASH24634	89414	AX310	83215	C0TZ18124A	83216	C4HZ18124C	83314
ASH24658	85181	B7T-18124-C	83225	C1TT-18045-C	83312	C4HZ18124D	83312
ASH24659	85181	B7T18124C	83225	C1TT-18045-C	89409	C4HZ18124D	89409
ASH24660	85180	B7TZ-18124-B	83216	C1TT-18045-E	83314	C4HZ18124E	83309
ASH24661	83317	B7TZ-18124-C	83216	C1TT-18045-G	83216	C4HZ18124F	83308
ASH24662	83168	B7TZ18124B	83216	C1TT18045C	83312	C4PF-18045-H	83216
ASH24663	83148	B7TZ18124C	83216	C1TT18045C	89409	C4PF18045H	83216
ASH247	G63461	B8QZ-18124-A	83312	C1TT18045E	83314	C4TZ-18124-AA	83308
ASH25820	85005	B8QZ-18124-A	89409	C1TT18045G	83216	C4TZ-18124-AB	83308
ASH25820	89430	B8QZ18124A	83312	C1TZ-18045-C	83312	C4TZ-18124-B	83308
ASH25821	85006	B8QZ18124A	89409	C1TZ-18045-C	89409	C4TZ18124AA	83308
ASH25822	83209	BC3Z 18124-AA	G63886	C1TZ-18124-B	83216	C4TZ18124AB	83308
ASH25822	89414	BC3Z 18124-B	G63622	C1TZ-18124-C	83312	C4TZ18124B	83308
ASH25823	83209	BC3Z 18124-C	G63622	C1TZ-18124-C	89409	C5TZ-18124-A	83308
ASH25823	89414	BC3Z 18124-K	G63886	C1TZ-18124-D	83309	C5TZ18124A	83308
ASH25824	83122	BC3Z 18124-M	G63886	C1TZ-18124-E	83312	C6PF-18077-A	G63306
ASH25824	89406	BC3Z 18124-N	G63886	C1TZ-18124-E	89409	C6PF-18077-DD	83216
ASH25838	85978	BC3Z 18124-R	G63886	C1TZ-18124-F	83312	C6PF-18077-DL	83312
ASH294	83209	BC3Z 18124-T	G63886	C1TZ-18124-F	89409	C6PF-18077-DL	89409
ASH294	89414	BC3Z 18124-U	G63886	C1TZ-18124-N	83314	C6PF-18077-DN	83314
ASH397	83131	BC3Z 18124-X	G63886	C1TZ-18124-P	83312	C6PF-18077-F	83225
ASH722	85976	BC3Z 18124-Y	G63886	C1TZ-18124-P	89409	C6PF18077A	G63306
AT-163G	G63622	BC3Z 18124-Z	G63886	C1TZ18045C	83312	C6PF18077DD	83216
AT-164G	G63623	BC3Z 18125-A	G64010	C1TZ18045C	89409	C6PF18077DL	83312
AT-610	G63461	BC3Z 18125-AE	G63888	C1TZ18124B	83216	C6PF18077DL	89409
AT-611	G63461	BC3Z 18125-AF	G63888	C1TZ18124C	83312	C6PF18077DN	83314
AT-620	83209	BC3Z 18125-AL	G63888	C1TZ18124C	89409	C6PF18077F	83225
AT-620	89414	BC3Z 18125-B	G64010	C1TZ18124D	83309	C7HZ-18124-A	83312
AT-621	83122	BC3Z 18125-J	G63888	C1TZ18124E	83312	C7HZ-18124-A	89409
AT-621	89406	BC3Z 18125-L	G63888	C1TZ18124E	89409	C7HZ18124A	83312
AT-696	83140	BC3Z 18125-M	G63888	C1TZ18124F	83312	C7HZ18124A	89409
AT-766	83209	BC3Z 18125-N	G63888	C1TZ18124F	89409	C7PF-18077-A	83225
AT-766	89414	BC3Z 18125-R	G63888	C1TZ18124N	83314	C7PF18077A	83225
AT-811	83135	BC3Z-18124-A	G63622	C1TZ18124P	83312	C7TA-18045-R	83216
AT-812	85928	BC3Z-18124-AB	G63886	C1TZ18124P	89409	C7TA18045R	83216
AT163G	G63622	BC3Z-18124-AC	77967	C2TA-18045-A	83216	C8HA-18045-A	83312
AT163G	G63623	BC3Z-18124-F	G63886	C2TA-18045-B	83308	C8HA-18045-A	89409

Important Note: Competitive Interchanges are to be used for stocking purposes only. Where multiple crosses are identified, please reference the applications section of this catalog. / **Remarque importante:** Les interchanges concurrentiels ne s'utilisent qu'aux fins de stocks. Dans le cas de références multiples, consulter la section des applications du catalogue. / **Nota importante:** Dans le cas de références multiples, consulter la section des applications du catalogue. / **Nota importante:** Se pueden usar intercambios competitivos para propósitos de almacenamiento solamente. Cuando se identifican intercambios múltiples, consulte la sección de aplicaciones de este catálogo.

COMPETITIVE & O.E.M. INTERCHANGE LIST
Lista de Intercambios contra Competidores y Equipo Original.
Liste d'interchange de produits compétitifs & équipement original (OEM)

Ford... cont'd

Ford	Gabriel	Ford	Gabriel	Ford	Gabriel	Ford	Gabriel
C8HA18045A	83312	D2HF18045BA	83309	D2TZ-18124-J	89409	D7HT-18124-CA	83314
C8HA18045A	89409	D2HF18045CA	83308	D2TZ18124A	83308	D7HT-18124-DA	83309
C8PF-18045-CM	83216	D2HF18045DA	83312	D2TZ18124E	83312	D7HT-18124-EA	83312
C8PF18045CM	83216	D2HF18045DA	89409	D2TZ18124E	89409	D7HT-18124-EA	89409
C8TA-18045-AA	G63386	D2HF18124AA	83314	D2TZ18124F	83309	D7HT-18124-FA	83312
C8TA18045AA	G63386	D2HT-18045-CA	83314	D2TZ18124G	83314	D7HT-18124-FA	89409
CK4Z-18124-E	G57816	D2HT-18045-EA	83312	D2TZ18124H	83308	D7HT-18124-GA	83308
CU9Z-18124-A	85013	D2HT-18045-EA	89409	D2TZ18124J	83312	D7HT-18124-JA	83308
CU9Z-18124-A	89414	D2HT-18045-GA	83308	D2TZ18124J	89409	D7HT-18125-DA	83215
CU9Z-18125-A	85010	D2HT-18080-HA	83225	D4HA-18080-A	83209	D7HT-18125-FA	83123
CU9Z18124A	85013	D2HT18045CA	83314	D4HA-18080-A	89414	D7HT-18125-FA	89405
CU9Z18124A	89414	D2HT18045EA	83312	D4HA-18080-AA	83209	D7HT18045BA	83312
CU9Z18125A	85010	D2HT18045EA	89409	D4HA-18080-AA	89414	D7HT18045BA	89409
D0HA-18045-D	83309	D2HT18045GA	83308	D4HA18080A	83209	D7HT18045CA	83314
D0HA-18045-E	83312	D2HT18080HA	83225	D4HA18080A	89414	D7HT18045DA	83309
D0HA-18045-E	89409	D2HZ-18080-A	83209	D4HA18080AA	83209	D7HT18045EA	83312
D0HA18045D	83309	D2HZ-18080-A	89414	D4HA18080AA	89414	D7HT18045EA	89409
D0HA18045E	83312	D2HZ-18125-A	83209	D4TF-18045-AA	83312	D7HT18045GA	83308
D0HA18045E	89409	D2HZ-18125-A	89414	D4TF-18045-AA	89409	D7HT18045JA	83308
D0HZ-18124-A	83309	D2HZ-18125-B	83209	D4TF18045AA	83312	D7HT18080BA	83225
D0HZ-18124-B	83312	D2HZ-18125-B	89414	D4TF18045AA	89409	D7HT18080DA	83215
D0HZ-18124-B	89409	D2HZ18080A	83209	D4TZ-18124-J	83308	D7HT18124BA	83312
D0HZ-18124-C	83314	D2HZ18080A	89414	D4TZ18124J	83308	D7HT18124BA	89409
D0HZ18124A	83309	D2HZ18125A	83209	D5TZ-18124-B	83308	D7HT18124CA	83314
D0HZ18124B	83312	D2HZ18125A	89414	D5TZ-18124-C	83312	D7HT18124DA	83309
D0HZ18124B	89409	D2HZ18125B	83209	D5TZ-18124-C	89409	D7HT18124EA	83312
D0HZ18124C	83314	D2HZ18125B	89414	D5TZ18124B	83308	D7HT18124EA	89409
D1TF-18045-LA	83312	D2KF-18045-AA	83312	D5TZ18124C	83312	D7HT18124FA	83312
D1TF-18045-LA	89409	D2KF-18045-AA	89409	D5TZ18124C	89409	D7HT18124FA	89409
D1TF18045LA	83312	D2KF-18124-AA	83312	D7HA-18080-AA	83123	D7HT18124GA	83308
D1TF18045LA	89409	D2KF-18124-AA	89409	D7HA-18080-AA	89405	D7HT18124JA	83308
D1TZ-18124-D	83308	D2KF18045AA	83312	D7HA18080AA	83123	D7HT18125DA	83215
D1TZ-18124-E	83216	D2KF18045AA	89409	D7HA18080AA	89405	D7HT18125FA	83123
D1TZ-18124-F	83312	D2KF18124AA	83312	D7HF-18045-FA	83312	D7HT18125FA	89405
D1TZ-18124-F	89409	D2KF18124AA	89409	D7HF-18045-FA	89409	D7HZ-18125-A	83215
D1TZ18124D	83308	D2TF-18045-AA	83312	D7HF-18080-AA	83215	D7HZ18125A	83215
D1TZ18124E	83216	D2TF-18045-AA	89409	D7HF-18125-AA	83215	D7KF-18045-EA	83312
D1TZ18124F	83312	D2TF-18045-FA	83312	D7HF18045FA	83312	D7KF-18045-EA	89409
D1TZ18124F	89409	D2TF-18045-FA	89409	D7HF18045FA	89409	D7KF18045EA	83312
D2EF-18045-AA	83312	D2TF-18045-GA	83308	D7HF18080AA	83215	D7KF18045EA	89409
D2EF-18045-AA	89409	D2TF-18080-HA	83225	D7HF18125AA	83215	D7TA-18124-GA	83314
D2EF-18124-AA	83312	D2TF-18124-F	83309	D7HT-18045-BA	83312	D7TA18124GA	83314
D2EF-18124-AA	89409	D2TF18045AA	83312	D7HT-18045-BA	89409	D8HZ-18125-A	83209
D2EF18045AA	83312	D2TF18045AA	89409	D7HT-18045-CA	83314	D8HZ-18125-A	89414
D2EF18045AA	89409	D2TF18045FA	83312	D7HT-18045-DA	83309	D8HZ-18125-B	83123
D2EF18124AA	83312	D2TF18045FA	89409	D7HT-18045-EA	83312	D8HZ-18125-B	89405
D2EF18124AA	89409	D2TF18045GA	83308	D7HT-18045-EA	89409	D8HZ18125A	83209
D2HF-18045-A	83314	D2TF18080HA	83225	D7HT-18045-GA	83308	D8HZ18125A	89414
D2HF-18045-AA	83314	D2TF18124F	83309	D7HT-18045-HA	85012	D8HZ18125B	83123
D2HF-18045-BA	83309	D2TZ-18124-A	83308	D7HT-18045-HA	89413	D8HZ18125B	89405
D2HF-18045-CA	83308	D2TZ-18124-E	83312	D7HT-18045-JA	83308	DU94-18045-CB	85013
D2HF-18045-DA	83312	D2TZ-18124-E	89409	D7HT-18080-BA	83225	DU94-18045-CB	89414
D2HF-18045-DA	89409	D2TZ-18124-F	83309	D7HT-18080-CA	83225	DU94-18080-CA	85010
D2HF-18124-AA	83314	D2TZ-18124-G	83314	D7HT-18080-DA	83215	DU94-18080-CB	85010
D2HF18045A	83314	D2TZ-18124-H	83308	D7HT-18124-BA	83312	DU9418080CA	85010
D2HF18045AA	83314	D2TZ-18124-J	83312	D7HT-18124-BA	89409	DU9418080CB	85010

Important Note: Competitive Interchanges are to be used for stocking purposes only. Where multiple crosses are identified, please reference the applications section of this catalog. / **Remarque importante:** Les interchanges concurrentiels ne s'utilisent qu'aux fins de stocks. Dans le cas de références multiples, consulter la section des applications du catalogue. / **Nota importante:** Dans le cas de références multiples, consulter la section des applications du catalogue. / **Nota importante:** Se pueden usar intercambios competitivos para propósitos de almacenamiento solamente. Cuando se identifican intercambios múltiples, consulte la sección de aplicaciones de este catálogo.

COMPETITIVE & O.E.M. INTERCHANGE LIST
Lista de Intercambios contra Competidores y Equipo Original.
Liste d'interchange de produits compétitifs & déquippement original (OEM)

Ford... cont'd

Ford	Gabriel	Ford	Gabriel	Ford	Gabriel	Ford	Gabriel
DU9Z-18124-A	85013	F0HZ-18124-A	85006	F4HT18045AB	83314	F81A-18080-DCA	G63461
DU9Z-18124-A	89414	F0HZ-18124-B	85006	F4HT18045AC	83314	F81A-18080-ZC	83140
DU9Z-18124-B	85013	F0HZ-18125-A	83122	F4HT18080AA	89425	F81A18080DCA	G63461
DU9Z-18124-B	89414	F0HZ-18125-A	89406	F4HT18080AB	89425	F81A18080ZC	83140
DU9Z-18125-A	85010	F0HZ18124A	85006	F4TA-18045-TA	G63455	F81D-18045-CD	83209
DU9Z-18125-B	85010	F0HZ18124B	85006	F4TA-18080-PA	G63461	F81D-18045-CD	89414
DU9Z18124A	85013	F0HZ18125A	83122	F4TA18045TA	G63455	F81D-18080-CD	83122
DU9Z18124A	89414	F0HZ18125A	89406	F4TA18080PA	G63461	F81D-18080-CD	89406
DU9Z18124B	85013	F1HT-18045-AA	83309	F4TZ-18124-K	G63455	F81D18045CD	83209
DU9Z18124B	89414	F1HT-18045-CA	83308	F4TZ-18125-E	G63461	F81D18045CD	89414
DU9Z18125A	85010	F1HT-18045-CB	83216	F4TZ18124K	G63455	F81D18080CD	83122
DU9Z18125B	85010	F1HT-18045-DA	83312	F4TZ18125E	G63461	F81D18080CD	89406
E0HT-18045-AA	83309	F1HT-18045-DA	89409	F5HZ-18124-A	83314	F81Z-18124-AL	G63622
E0HT-18045-AB	83309	F1HT-18045-DB	83308	F5HZ-18124-AA	83314	F81Z-18124-BK	G63809
E0HT18045AA	83309	F1HT-18045-GA	85006	F5HZ-18125-A	89425	F81Z-18124-CA	83209
E0HT18045AB	83309	F1HT-18045-GB	85006	F5HZ-18125-AA	89425	F81Z-18124-CA	89414
E0HZ-18124-A	83309	F1HT-18045-HB	85006	F5HZ-18125-DA	89425	F81Z-18124-PA	85928
E0HZ18124A	83309	F1HT-18045-KB	85006	F5HZ18124A	83314	F81Z-18125-DC	G63461
E1TA-18045-AA	83309	F1HT-18045-LB	85006	F5HZ18124AA	83314	F81Z-18125-FA	83122
E1TA18045AA	83309	F1HT18045AA	83309	F5HZ18125A	89425	F81Z-18125-FA	89406
E1TD-18045-AA	83309	F1HT18045CA	83308	F5HZ18125AA	89425	F81Z-18125-ZA	83140
E1TD18045AA	83309	F1HT18045CB	83216	F5HZ18125DA	89425	F81Z18124AL	G63622
E6HT-18080-AA	83215	F1HT18045DA	83312	F5TZ-18125-BC	G63607	F81Z18124BK	G63809
E6HT18080AA	83215	F1HT18045DA	89409	F5TZ18125BC	G63607	F81Z18124CA	83209
E6HZ-18125-D	83215	F1HT18045DB	83308	F5UZ-18124-A	G63622	F81Z18124CA	89414
E6HZ18125D	83215	F1HT18045GA	85006	F5UZ-18124-B	G63622	F81Z18124PA	85928
E7XZ-18124-A	G63386	F1HT18045GB	85006	F5UZ-18125-A	G63623	F81Z18125DC	G63461
E7XZ-18125-A	G63350	F1HT18045HB	85006	F5UZ18124A	G63622	F81Z-18125-FA	83122
E7XZ-18125-B	G63387	F1HT18045KB	85006	F5UZ18124B	G63622	F81Z18125FA	89406
E7XZ-18125-C	G63409	F1HT18045LB	85006	F5UZ18125A	G63623	F81Z18125ZA	83140
E7XZ-18125-J	G63299	F1HZ-18124-A	83309	F6HT-18045-MA	85006	FC44-18045-AB	85181
E7XZ18124A	G63386	F1HZ-18124-AA	83309	F6HT-18080-CA	89425	FC44-18045-BB	85181
E7XZ18125A	G63350	F1HZ-18124-B	83308	F6HT-18080-FC	85013	FC44-18080-AB	85180
E7XZ18125B	G63387	F1HZ-18124-D	85006	F6HT-18080-FC	89414	FC4418045BB	85181
E7XZ18125C	G63409	F1HZ-18124-E	85006	F6HT18045MA	85006	FC4418080AB	85180
E7XZ18125J	G63299	F1HZ-18124-F	85006	F6HT18080CA	89425	FC4Z-18124-A	85181
E9HS-18045-AA	83309	F1HZ-18124-G	85006	F6HT18080FC	85013	FC4Z-18124-B	85181
E9HS-18080-AA	85716	F1HZ-18124-J	83308	F6HT18080FC	89414	FC4Z-18124-HB	83135
E9HS18045AA	83309	F1HZ18124A	83309	F6HZ-18080-FC	85013	FC4Z-18125-A	85180
E9HS18080AA	85716	F1HZ18124AA	83309	F6HZ-18080-FC	89414	FC4Z-18125-C	83168
E9HZ-18124-A	83309	F1HZ18124B	83308	F6HZ-18124-B	83308	FC4Z-18125-D	83148
E9HZ-18125-A	85716	F1HZ18124D	85006	F6HZ-18124-MA	85006	FC4Z-18125-E	85978
E9HZ-18125-AA	85716	F1HZ18124E	85006	F6HZ-18125-A	89425	FC4Z18124A	85181
E9HZ18124A	83309	F1HZ18124F	85006	F6HZ-18125-D	85013	FC4Z18124B	85181
E9HZ18125A	85716	F1HZ18124G	85006	F6HZ-18125-D	89414	FC4Z18124HB	83135
E9HZ18125AA	85716	F1HZ18124J	83308	F6HZ18080FC	85013	FC4Z18125A	85180
F0HS-18045-AA	85006	F2HT-18045-DA	85006	F6HZ18080FC	89414	FC4Z18125C	83168
F0HS18045AA	85006	F2HT18045DA	85006	F6HZ18124B	83308	FC4Z18125D	83148
F0HT-18045-AA	85006	F2HZ-18124-C	85006	F6HZ18124MA	85006	FC4Z18125E	85978
F0HT-18045-CA	85006	F2HZ-18124-CA	85006	F6HZ18125A	89425	FK3Z-18124-M	G57816
F0HT-18080-AA	83122	F2HZ18124C	85006	F6HZ18125D	85013	FK3Z-18125-C	G64177
F0HT-18080-AA	89406	F2HZ18124CA	85006	F6HZ18125D	89414	FK4Z-18124-N	G57816
F0HT18045AA	85006	F4HT-18045-AB	83314	F77A-18080-BA	G63607	FK4Z-18125-C	G57816
F0HT18045CA	85006	F4HT-18045-AC	83314	F77A18080BA	G63607	HC3Z-18124-B	G63622
F0HT18080AA	83122	F4HT-18080-AA	89425	F7TA-18080-BA	G63607	HC3Z-18124-C	G63622
F0HT18080AA	89406	F4HT-18080-AB	89425	F7TA18080BA	G63607	HC3Z-18124-G	G63622

Important Note: Competitive Interchanges are to be used for stocking purposes only. Where multiple crosses are identified, please reference the applications section of this catalog. / **Remarque importante:** Les interchanges concurrentiels ne s'utilisent qu'aux fins de stocks. Dans le cas de références multiples, consulter la section des applications du catalogue. / **Nota importante:** Dans le cas de références multiples, consulter la section des applications du catalogue. / **Nota importante:** Se pueden usar intercambios competitivos para propósitos de almacenamiento solamente. Cuando se identifican intercambios múltiples, consulte la sección de aplicaciones de este catálogo.

COMPETITIVE & O.E.M. INTERCHANGE LIST
Lista de Intercambios contra Competidores y Equipo Original.
Liste d'interchange de produits compétitifs & équipement original (OEM)

Ford... cont'd

Ford	Gabriel	Ford	Gabriel	Ford	Gabriel	Ford	Gabriel
HC3Z-18124-J	77967	HU9Z-18124-B	89414	HU9Z18125A	89430	TANNA18045A	89409
HC3Z-18124-U	G63886	HU9Z-18124-C	83209	HU9Z18125B	83122	TQSH-18045-A	83309
HC3Z-18125-B	77987	HU9Z-18124-C	89414	HU9Z18125B	89406	TQSH18045A	83309
HC3Z-18125-ED	77987	HU9Z-18125-A	85005	HU9Z18125C	83122	XC35-18045-AB	83131
HC3Z-18125-EE	77987	HU9Z-18125-A	89430	HU9Z18125C	89406	XC35-18045-AD	83131
HC3Z-18125-EP	77986	HU9Z-18125-B	83122	KC3Z-3E651-C	14072	XC35-18045-JA	83131
HC3Z-18125-X	77986	HU9Z-18125-B	89406	LC3Z-18125-J	77986	XC3518045AB	83131
HU9418045AA	83209	HU9Z-18125-C	83122	LC3Z-18125-W	77986	XC3518045AD	83131
HU9418045AA	89414	HU9Z-18125-C	89406	M7C3Z-18124-AKA	G63622	XC3518045JA	83131
HU9418045BA	83209	HU9Z18124A	85006	MAA568	G63614	XC3Z-18124-JA	83131
HU9418045BA	89414	HU9Z18124B	83209	TACAA-18045-A	83216	XC3Z18124JA	83131
HU9Z-18045-AA	83209	HU9Z18124B	89414	TACAA18045A	83216	XC45-18045-AA	83216
HU9Z-18045-BA	83209	HU9Z18124C	83209	TANNA-18045-A	83312	XC4518045AA	83216
HU9Z-18124-A	85006	HU9Z18124C	89414	TANNA-18045-A	89409		
HU9Z-18124-B	83209	HU9Z18125A	85005	TANNA18045A	83312		

Forest River

Forest River	Gabriel	Forest River	Gabriel	Forest River	Gabriel	Forest River	Gabriel
141700131809	85029	9U94-18080-AA	83122	ASH-1230	89406	ASH1230	89406
141700131810	83160	9U94-18080-AA	89406	ASH-137	83122	ASH137	83122
16-16736-000	85029	9U9418045AA	83209	ASH-137	89406	ASH137	89406
16-16737-000	83160	9U9418045AA	89414	ASH-25820	85005	ASH25820	85005
16-16873-000	85029	9U9418080AA	83122	ASH-25820	89430	ASH25820	89430
16-16874-000	83160	9U9418080AA	89406	ASH-25821	85006	ASH25821	85006
16-18103-000	85900	9U9Z-18124-A	83209	ASH-25822	83209	ASH25822	83209
1616736000	85029	9U9Z-18124-A	89414	ASH-25822	89414	ASH25822	89414
1616737000	83160	9U9Z-18125-A	83122	ASH-25823	83209	ASH25823	83209
1616873000	85029	9U9Z-18125-A	89406	ASH-25823	89414	ASH25823	89414
1616874000	83160	9U9Z18124A	83209	ASH-25824	83122	ASH25824	83122
1618103000	85900	9U9Z18124A	89414	ASH-25824	89406	ASH25824	89406
1C34-18045-AA	83209	9U9Z18125A	83122	ASH-294	83209	ASH294	83209
1C34-18045-AA	89414	9U9Z18125A	89406	ASH-294	89414	ASH294	89414
1C34-18045-JA	83209	ASH-1022	83209	ASH1022	83209	AT-163G	G63622
1C34-18045-JA	89414	ASH-1022	89414	ASH1022	89414	AT-164G	G63623
1C3418045AA	83209	ASH-1023	83122	ASH1023	83122	AT-620	83209
1C3418045AA	89414	ASH-1023	89406	ASH1023	89406	AT-620	89414
1C3418045JA	83209	ASH-1136	G63623	ASH1136	G63623	AT-621	83122
1C3418045JA	89414	ASH-1154	G63622	ASH1154	G63622	AT-621	89406
481700000490	85900	ASH-1161	85006	ASH1161	85006	AT-766	83209
481700000493	85900	ASH-1162	85005	ASH1162	85005	AT-766	89414
8C24-18045-DA	G63622	ASH-1162	89430	ASH1162	89430	AT163G	G63622
8C24-18080-DB	G63623	ASH-1205	83209	ASH1205	83209	AT164G	G63623
8C2418045DA	G63622	ASH-1205	89414	ASH1205	89414	AT620	83209
8C2418080DB	G63623	ASH-1206	83122	ASH1206	83122	AT620	89414
8C2Z-18124-D	G63622	ASH-1206	89406	ASH1206	89406	AT621	83122
8C2Z-18125-D	G63623	ASH-1228	83209	ASH1228	83209	AT621	89406
8C2Z18124D	G63622	ASH-1228	89414	ASH1228	89414	AT766	83209
8C2Z18125D	G63623	ASH-1229	83209	ASH1229	83209	AT766	89414
9U94-18045-AA	83209	ASH-1229	89414	ASH1229	89414		
9U94-18045-AA	89414	ASH-1230	83122	ASH1230	83122		

Freightliner

Freightliner	Gabriel	Freightliner	Gabriel	Freightliner	Gabriel	Freightliner	Gabriel
10-12396-000	85918	10-13021-000	89449	10-13205-000	85918	10-13634-000	89449
10-12396-000	89449	10-13051-001	85005	10-13205-000	89449	10-13684-000	85918
10-12703-000	85918	10-13051-001	89430	10-13211-000	85918	10-13684-000	89449
10-12703-000	89449	10-13063-000	85918	10-13211-000	89449	10-13759-000	85006
10-13021-000	85918	10-13063-000	89449	10-13634-000	85918	10-13776-000	85005

Important Note: Competitive Interchanges are to be used for stocking purposes only. Where multiple crosses are identified, please reference the applications section of this catalog. / **Remarque importante:** Les interchanges concurrentiels ne s'utilisent qu'aux fins de stocks. Dans le cas de références multiples, consulter la section des applications du catalogue. / **Nota importante:** Dans le cas de références multiples, consulter la section des applications du catalogue. / **Nota importante:** Se pueden usar intercambios competitivos para propósitos de almacenamiento solamente. Cuando se identifican intercambios múltiples, consulte la sección de aplicaciones de este catálogo.

COMPETITIVE & O.E.M. INTERCHANGE LIST
Lista de Intercambios contra Competidores y Equipo Original.
Liste d'interchange de produits compétitifs & déquippement original (OEM)

Freightliner... cont'd

Freightliner	Gabriel	Freightliner	Gabriel	Freightliner	Gabriel	Freightliner	Gabriel
10-13776-000	89430	16-13957-000	89443	16-18455-000	89449	1616764000	85724
10-13859-000	85005	16-14259-000	85331	16-18706-000	85331	1616764000	89443
10-13859-000	89430	16-14577-000	85043	16-18707-000	85921	1616765000	85006
10-13976-000	85918	16-14667-000	85005	16-18708-000	85724	1616826000	85043
10-13976-000	89449	16-14667-000	89430	16-18708-000	89443	1616827000	85331
1012396000	85918	16-14668-000	83127	16-18709-000	83134	1616836000	83154
1012396000	89449	16-14669-000	G63403	16-18710-000	83134	1616873000	85029
1012703000	85918	16-14794-000	83154	16-18711-000	85335	1616874000	83160
1012703000	89449	16-15064-000	83154	16-19138-000	85058	1617144000	85900
1013021000	85918	16-15089-000	83164	16-19138-000	89431	1617361000	85900
1013021000	89449	16-15394-000	83120	16-20552-000	83154	1617684000	85058
1013051001	85005	16-15436-000	83154	16-20628-000	85058	1617684000	89431
1013051001	89430	16-15473-000	83157	16-20628-000	89431	1617759000	85919
1013063000	85918	16-15474-000	83157	16-20632-000	85919	1617760000	85331
1013063000	89449	16-15475-000	83164	16-20716-000	85724	1618076000	83160
1013205000	85918	16-15591-000	85043	16-20716-000	89443	1618103000	85900
1013205000	89449	16-15592-000	83154	16-22004-000	85058	1618455000	85918
1013211000	85918	16-15676-000	85058	16-22004-000	89431	1618455000	89449
1013211000	89449	16-15676-000	89431	1613957000	85724	1618706000	85331
1013634000	85918	16-15705-000	83120	1613957000	89443	1618707000	85921
1013634000	89449	16-15755-000	85043	1614259000	85331	1618708000	85724
1013684000	85918	16-15765-000	85921	1614577000	85043	1618708000	89443
1013684000	89449	16-15770-000	85956	1614667000	85005	1618709000	83134
1013759000	85006	16-15805-000	83120	1614667000	89430	1618710000	83134
1013776000	85005	16-15817-000	85724	1614668000	83127	1618711000	85335
1013776000	89430	16-15817-000	89443	1614669000	G63403	1619138000	85058
1013859000	85005	16-15934-000	83120	1614794000	83154	1619138000	89431
1013859000	89430	16-16043-000	85043	1615064000	83154	1620552000	83154
1013976000	85918	16-16082-000	85043	1615394000	83120	1620632000	85919
1013976000	89449	16-16083-000	85331	1615436000	83154	1620716000	85724
1201-0054	83021	16-16093-000	83160	1615473000	83157	1620716000	89443
1201-1043	83025	16-16262-000	83120	1615474000	83157	16725-01	83126
1201-1044	83025	16-16442-000	83134	1615475000	83164	16725-01	89430
12010054	83021	16-16486-000	83134	1615591000	85043	1672501	83126
12011043	83025	16-16542-000	83154	1615592000	83154	1672501	89430
12011044	83025	16-16577-000	85335	1615676000	85058	17455-00	89430
1202-0042	83025	16-16736-000	85029	1615676000	89431	18-30378	83006
1202-0043	83025	16-16737-000	83160	1615705000	83120	18-30378-000	83006
1202-0044	83025	16-16764-000	85724	1615755000	85043	18-32999-001	83006
1202-0054	83021	16-16764-000	89443	1615765000	85921	18-60295-000	83006
1202-1043	83025	16-16765-000	85006	1615770000	85956	1830378	83006
1202-1044	83025	16-16826-000	85043	1615805000	83120	1830378000	83006
12020042	83025	16-16827-000	85331	1615817000	85724	1832999001	83006
12020043	83025	16-16836-000	83154	1615817000	89443	1860295000	83006
12020044	83025	16-16873-000	85029	1615934000	83120	19495-01	83126
12020054	83021	16-16874-000	83160	1616043000	85043	19495-01	89430
12021043	83025	16-17144-000	85900	1616082000	85043	1949501	83126
12021044	83025	16-17361-000	85900	1616083000	85331	1949501	89430
1398980	83127	16-17684-000	85058	1616093000	83160	3638112	G63183
141700000377	83160	16-17684-000	89431	1616262000	83120	471700000447	85919
141700000378	83160	16-17759-000	85919	1616442000	83134	471700000449	85918
141700131809	85029	16-17760-000	85331	1616486000	83134	471700000449	89449
141700131810	83160	16-18075-000	83160	1616542000	83154	471700000450	89449
141700131975	83160	16-18076-000	83160	1616577000	85335	471700000470	85918
141700131980	83160	16-18103-000	85900	1616736000	85029	471700000470	89449
16-13957-000	85724	16-18455-000	85918	1616737000	83160	471700002726	85918

Important Note: Competitive Interchanges are to be used for stocking purposes only. Where multiple crosses are identified, please reference the applications section of this catalog. / **Remarque importante:** Les interchanges concurrentiels ne s'utilisent qu'aux fins de stocks. Dans le cas de références multiples, consulter la section des applications du catalogue. / **Nota Importante:** Dans le cas de références multiples, consulter la section des applications du catalogue. / **Nota Importante:** Se pueden usar intercambios competitivos para propósitos de almacenamiento solamente. Cuando se identifican intercambios múltiples, consulte la sección de aplicaciones de este catálogo.

COMPETITIVE & O.E.M. INTERCHANGE LIST
Lista de Intercambios contra Competidores y Equipo Original.
Liste d'interchange de produits compétitifs & équipement original (OEM)

Freightliner... cont'd

Freightliner	Gabriel	Freightliner	Gabriel	Freightliner	Gabriel	Freightliner	Gabriel
471700002726	89449	471700131974	85029	58913012L	89453	6803260000	83120
471700002808	85724	47902-13	83122	60680-004	83143	680339	85724
471700002808	89443	47902-13	89406	60680-004L	83143	680339	89443
471700002809	85724	4790213	83122	60680-005	83142	680511	85331
471700002809	89443	4790213	89406	60680-005L	83142	680611	85724
471700002992	85331	481700000477	85900	60680004	83143	680611	89443
471700002993	85921	481700000480	85900	60680004L	83143	680651	85335
471700002994	83134	481700000490	85900	60680005	83142	681-323-0900	85009
471700002995	83134	481700000493	85900	60680005L	83142	6813230900	85009
471700002996	85335	481700006848	85724	61300224	85918	GBL654725	83120
471700003000	85335	481700006848	89443	61300224	89449	GBL654726	83120
471700003009	85006	481700006850	85724	61300240	85918	GBL654727	83120
471700003011	85058	481700006850	89443	61300240	89449	GBL654728	83120
471700003011	89431	481700125969	85956	650224	83225	GBL654729	83120
471700005079	85005	481700125970	85956	654654	85043	GBL654730	83120
471700005079	89430	481700131919	85900	654831	83006	GBL654731	83120
471700006269	85932	481700131920	85900	654953	85058	GBL654732	83120
471700006269	89453	58913-003	85932	654953	89431	GBL654733	83120
471700010991	83154	58913-003	89453	659062	83134	GBL654734	83120
471700011302	85058	58913-003L	85932	659063	83134	GBL654735	83120
471700011302	89431	58913-003L	89453	659227	85058	GBL665538	85006
471700131155	85918	58913-012	85932	659227	89431	H60680004	83143
471700131155	89449	58913-012	89453	659288	83006	HDR60680-004	83143
471700131331	85932	58913-012L	85932	659300	85005	HDR60680-005	83142
471700131331	89453	58913-012L	89453	659300	89430	HDR60680004	83143
471700131646	85918	58913003	85932	665409	85009	HDR60680005	83142
471700131646	89449	58913003	89453	66554540I	89430	MAE 16949	83120
471700131650	85918	58913003L	85932	671908	85918	P117099	83120
471700131650	89449	58913003L	89453	671908	89449	SDA471700002809	85724
471700131775	85006	58913012	85932	671946	85921	SDA471700002809	89443
471700131778	85331	58913012	89453	6803230200	85043		
471700131780	85331	58913012L	85932	6803230300	85006		

Fruehauf

Fruehauf	Gabriel	Fruehauf	Gabriel	Fruehauf	Gabriel	Fruehauf	Gabriel
5116-117	83122	5116117	83122	UCE-9399-1	83122	UCE93991	83122
5116-117	89406	5116117	89406	UCE-9399-1	89406	UCE93991	89406

GasSLX

GasSLX	Gabriel	GasSLX	Gabriel	GasSLX	Gabriel	GasSLX	Gabriel
89405	83123	89414	85013	89443	85724	89455	85069
89406	83122	89424	85311	89447	83456	89460	85084
89409	83312	89430	83126	89447	85705		
89413	85012	89430	85005	89449	85918		
89414	83209	89431	85058	89453	85932		

GasSLX - Fleetline

GasSLX - Fleetline	Gabriel	GasSLX - Fleetline	Gabriel	GasSLX - Fleetline	Gabriel	GasSLX - Fleetline	Gabriel
83122	89406	85005	89430	85084	89460	85918	89449
83123	89405	85012	89413	85311	89424	85923	89458
83126	89430	85013	89414	85314	89425	85931	89458
83209	89414	85036	89405	85705	89447	85932	89453
83312	89409	85058	89431	85724	89443		
83456	89447	85069	89455	85916	89430		

General Motors

General Motors	Gabriel	General Motors	Gabriel	General Motors	Gabriel	General Motors	Gabriel
1-51630-168-1	83515	1201-0054	83021	1202-0054	83021		
1-51630-217-0	83114	1201-1043	83025	1202-1043	83025		
1-51630-217-1	83114	12010054	83021	12020054	83021		
1-51630-219-1	83114	12011043	83025	12021043	83025		

Important Note: Competitive Interchanges are to be used for stocking purposes only. Where multiple crosses are identified, please reference the applications section of this catalog. / **Remarque importante:** Les interchanges concurrentiels ne s'utilisent qu'aux fins de stocks. Dans le cas de références multiples, consulter la section des applications du catalogue. / **Nota importante:** Dans le cas de références multiples, consulter la section des applications du catalogue. / **Nota importante:** Se pueden usar intercambios competitivos para propósitos de almacenamiento solamente. Cuando se identifican intercambios múltiples, consulte la sección de aplicaciones de este catálogo.

COMPETITIVE & O.E.M. INTERCHANGE LIST
Lista de Intercambios contra Competidores y Equipo Original.
Liste d'interchange de produits compétitifs & déquippement original (OEM)

General Motors... cont'd

General Motors	Gabriel	General Motors	Gabriel	General Motors	Gabriel	General Motors	Gabriel
12474719	61544	19402811	83397	22064829	61543	4975497	89430
12474719	G63489	19403619	83397	22064829	G63488	4975510	83221
12474721	43180	19403620	83397	22064830	58609	4975549	83216
12474721	49231	19404855	83135	22064830	61542	4984526	83216
12474721	58638	19407869	83397	22064830	61544	4993599	6804SE
12474721	61565	19407870	83398	22064830	77609	508-86	83136
12474721	77638	19407871	83397	22064830	G63489	50886	83136
12474721	G63638	19407873	83398	22064830	G63609	5171068	83216
12474915	83122	19408176	85670	22065218	G63347	5513489	83216
12474915	89406	20906289	G64121	22165187	83136	5544112	83216
12474917	83137	20908412	G64148	22165188	83136	5544812	83308
15123676	83136	20908414	G64148	22165189	83136	5552114	83216
1516301681	83515	20908415	G64148	22166442	83136	5552209	83215
1516302170	83114	20956372	G63896	25871225	49235	684280	83209
1516302171	83114	20956377	61687	25871229	49235	684280	89414
1516302191	83114	20956377	G63897	25948611	43181	8-51630-666-0	85012
15174898	83136	20956378	G63896	25984611	61600	8-51630-666-0	89413
15174902	85071	20956379	61687	25984613	58412	8-94057-593-0	83114
15588554	83136	20956379	G63897	25984613	61642	8-94454-986-0	83515
15642943	83136	20956380	61687	25984613	77412	8-94454-987-0	83515
15740554	83137	20956380	G63897	3171068	83216	8-97083-029-0	83515
15887728	83136	22002293	83126	3171462	83126	8-97201-960-0	83515
15935605	43181	22002293	89430	3171462	89430	8-97253-620-0	83515
15935605	61600	22007701	83126	3192657	83216	8-97253664-0	83159
15935611	58412	22007701	89430	3192890	83126	8-97253665-0	83159
15935611	61642	22012095	83126	3192890	89430	8-98380-746-0	83159
15935611	77412	22012095	89430	3192891	83221	8-98380-747-0	83159
15935621	43181	22012096	83221	3192892	83221	8-98381-010-0	83515
15935625	58412	22012166	83126	35901-0001	83209	8-98381-012-0	83515
15935625	61642	22012166	89430	35901-0001	89414	84303234	G63895
15935625	77412	22012169	83221	35901-0017	83314	88945846	61500
15935629	61600	22012196	83221	359010001	83209	88945861	61516
15963161	83122	22064013	61524	359010001	89414	88945867	61522
15963161	89406	22064013	G63349	359010017	83314	88945983	81039
19152843	83136	22064019	61524	3989717C1	83135	88945987	81096
19158776	58930	22064019	G63349	4089293C1	83397	88945990	81113
19167562	81039	22064226	61524	4109458C2	83243	88945991	81164
19167562	G63355	22064226	G63349	4109582C1	83397	88945992	81147
19168179	61641	22064230	83136	4109583C1	83397	88945995	81242
19168179	G63783	22064232	85071	4206863C1	83398	88945997	81270
19172175	6850SE	22064233	83136	4207304C1	83397	88945999	81340
19172178	6853SE	22064417	61544	4208946C1	83398	88946002	81394
19203641	61687	22064417	G63489	4214011C2	85670	88946009	81510
19235148	61683	22064432	83221	4940600	83209	88946010	81082
19241354	61684	22064635	58609	4940600	89414	88946023	81490
19241355	61685	22064635	61542	4940601	83216	88946028	81496
19257307	G63894	22064635	77609	4940606	83126	88946029	81484
19257308	G63893	22064635	G63609	4940606	89430	88946059	81667
19257309	G63894	22064684	58609	4940614	83216	88946060	81668
19257310	G63895	22064684	61542	4940640	83216	88946072	81713
19257311	G63893	22064684	77609	4940654	83216	88946106	82003
19295551	81318	22064684	G63609	4940662	83126	88946129	82026
19295552	81873	22064804	83136	4940662	89430	88946138	82035
19295553	81920	22064805	83136	4963853	83216	88946145	82047
19295557	81925	22064806	83136	4963854	83216	88946176	82086
19368462	49235	22064807	83136	4975497	83126	88946214	82155

Important Note: Competitive Interchanges are to be used for stocking purposes only. Where multiple crosses are identified, please reference the applications section of this catalog. / **Remarque importante:** Les interchanges concurrentiels ne s'utilisent qu'aux fins de stocks. Dans le cas de références multiples, consulter la section des applications du catalogue. / **Nota importante:** Dans le cas de références multiples, consulter la section des applications du catalogue. / **Nota importante:** Se pueden usar intercambios competitivos para propósitos de almacenamiento solamente. Cuando se identifican intercambios múltiples, consulte la sección de aplicaciones de este catálogo.

COMPETITIVE & O.E.M. INTERCHANGE LIST
Lista de Intercambios contra Competidores y Equipo Original.
Liste d'interchange de produits compétitifs & équipement original (OEM)

General Motors... cont'd

General Motors	Gabriel	General Motors	Gabriel	General Motors	Gabriel	General Motors	Gabriel
88946547	14017	88963009	77488	89038597	58412	9-51630-666-2	85012
88946553	34036	88963010	77488	89038597	77412	9-51630-666-2	89413
88946558	34073	88963010	77489	89038652	58817	94033786	83114
88946561	43048	88963017	77609	89038652	61663	94051090	83114
88946574	43111	88963020	77638	89038652	77817	94057593	83114
88946581	43163	88963023	77662	89038652	G63817	94454987	83515
88946588	43180	88963039	77783	89038654	43181	9516306471	83515
88946589	43181	88963046	77817	89038654	61600	9516306660	85012
88946592	49107	88963054	77907	8940575930	83114	9516306660	89413
88946604	49155	88966765	61506	8944549860	83515	9516306662	85012
88946607	49162	88966771	61517	8944549870	83515	9516306662	89413
88946618	49203	88966773	61519	8970830290	83515	97083027	83515
88946621	49212	88966777	61524	8972019600	83515	97083029	83515
88946627	49218	88966778	61525	8972536200	83515	97201960	83515
88946638	49231	88966792	61542	8972536640	83159	97253616	83515
88946642	49235	88966793	61543	8972536650	83159	97253620	83515
88946652	49311	88966794	61544	898098-0580	83159	97253621	83515
88946670	6802SE	88966801	61555	898098-0581	83159	97253623	83515
88946671	6803SE	88966809	61600	898098-0590	83159	97253651	83159
88946672	6804SE	88966810	61565	898098-1250	83515	97253664	83159
88959113	58357	88966850	61641	898098-1270	83515	97253665	83159
88959123	58403	88966851	61642	8980980580	83159	98098058	83159
88959128	58412	88966866	61663	8980980581	83159	98098059	83159
88959140	58488	88982682	83136	8980980590	83159	98098125	83515
88959141	58489	88982684	83136	8980981250	83515	98098127	83515
88959143	58609	88982686	85071	8980981270	83515	98232671	83515
88959149	58638	88983818	49235	8983807460	83159	98380746	83159
88959151	58662	88986629	61555	8983807470	83159	98380747	83159
88959173	58817	88986629	81713	8983810100	83515	98381010	83515
88962985	77403	88986629	G63375	8983810120	83515	98381012	83515
88962987	77375	89038591	61642	9-51630-647-1	83515	SG23086	61522
88962995	77412	89038595	61641	9-51630-666-0	85012		
88962995	77783	89038595	G63783	9-51630-666-0	89413		

Georgie Boy Manufacturing

Georgie Boy Manufacturing	Gabriel	Georgie Boy Manufacturing	Gabriel	Georgie Boy Manufacturing	Gabriel	Georgie Boy Manufacturing	Gabriel
10-13021-000	85918	16-15817-000	85724	1C3418045AA	83209	481700006848	89443
10-13021-000	89449	16-15817-000	89443	1C3418045AA	89414	4C4Z-18124-JB	85928
10-13063-000	85918	16-16736-000	85029	1C3418045JA	83209	4C4Z-18124-QA	83175
10-13063-000	89449	16-16737-000	83160	1C3418045JA	89414	4C4Z-18124-RA	85928
10-13211-000	85918	16-16873-000	85029	22064230	83136	4C4Z-18125-B	83317
10-13211-000	89449	16-16874-000	83160	3578858C1	85656	4C4Z-18125-DA	85656
10-13634-000	85918	16-18103-000	85900	3578858C2	85656	4C4Z18124JB	85928
10-13634-000	89449	16-18708-000	85724	3584116C1	83175	4C4Z18124QA	83175
10-13684-000	85918	16-18708-000	89443	3584116C2	83175	4C4Z18124RA	85928
10-13684-000	89449	1615817000	85724	3584118C2	85928	4C4Z18125DA	85656
1013021000	85918	1615817000	89443	471700000449	85918	501906C92	83317
1013021000	89449	1616736000	85029	471700000449	89449	680611	85724
1013063000	85918	1616737000	83160	471700002808	85724	680611	89443
1013063000	89449	1616873000	85029	471700002808	89443	8C24-18045-DA	G63622
1013211000	85918	1616874000	83160	471700002809	85724	8C24-18080-DB	G63623
1013211000	89449	1618103000	85900	471700002809	89443	8C2418045DA	G63622
1013634000	85918	1618708000	85724	471700011530	85181	8C2418080DB	G63623
1013634000	89449	1618708000	89443	471700011531	85180	8C2Z-18124-D	G63622
1013684000	85918	1C34-18045-AA	83209	471700131155	85918		
1013684000	89449	1C34-18045-AA	89414	471700131155	89449		
141700131809	85029	1C34-18045-JA	83209	481700000493	85900		
141700131810	83160	1C34-18045-JA	89414	481700006848	85724		

Important Note: Competitive Interchanges are to be used for stocking purposes only. Where multiple crosses are identified, please reference the applications section of this catalog. / **Remarque importante:** Les interchanges concurrentiels ne s'utilisent qu'aux fins de stocks. Dans le cas de références multiples, consulter la section des applications du catalogue. / **Nota importante:** Dans le cas de références multiples, consulter la section des applications du catalogue. / **Nota importante:** Se pueden usar intercambios competitivos para propósitos de almacenamiento solamente. Cuando se identifican intercambios múltiples, consulte la sección de aplicaciones de este catálogo.

COMPETITIVE & O.E.M. INTERCHANGE LIST
Lista de Intercambios contra Competidores y Equipo Original.
Liste d'interchange de produits compétitifs & déquippement original (OEM)

Georgie Boy Manufacturing... cont'd

Georgie Boy Manufacturing	Gabriel	Georgie Boy Manufacturing	Gabriel	Georgie Boy Manufacturing	Gabriel	Georgie Boy Manufacturing	Gabriel
8C2Z-18125-D	G63623	ASH-1162	89430	ASH1136	G63623	ASH294	89414
8C2Z18124D	G63622	ASH-1205	83209	ASH1154	G63622	AT-163G	G63622
8C2Z18125D	G63623	ASH-1205	89414	ASH1161	85006	AT-164G	G63623
9U94-18045-AA	83209	ASH-1206	83122	ASH1162	85005	AT-620	83209
9U94-18045-AA	89414	ASH-1206	89406	ASH1162	89430	AT-620	89414
9U94-18080-AA	83122	ASH-1228	83209	ASH1205	83209	AT-621	83122
9U94-18080-AA	89406	ASH-1228	89414	ASH1205	89414	AT-621	89406
9U9418045AA	83209	ASH-1229	83209	ASH1206	83122	AT-766	83209
9U9418045AA	89414	ASH-1229	89414	ASH1206	89406	AT-766	89414
9U9418080AA	83122	ASH-1230	83122	ASH1228	83209	AT-812	85928
9U9418080AA	89406	ASH-1230	89406	ASH1228	89414	AT163G	G63622
9U9Z-18124-A	83209	ASH-137	83122	ASH1229	83209	AT164G	G63623
9U9Z-18124-A	89414	ASH-137	89406	ASH1229	89414	AT620	83209
9U9Z-18125-A	83122	ASH-24658	85181	ASH1230	83122	AT620	89414
9U9Z-18125-A	89406	ASH-24659	85181	ASH1230	89406	AT621	83122
9U9Z18124A	83209	ASH-24660	85180	ASH137	83122	AT621	89406
9U9Z18124A	89414	ASH-25820	85005	ASH137	89406	AT766	83209
9U9Z18125A	83122	ASH-25820	89430	ASH24658	85181	AT766	89414
9U9Z18125A	89406	ASH-25821	85006	ASH24659	85181	AT812	85928
AA-616	83175	ASH-25822	83209	ASH24660	85180	FC44-18045-BB	85181
AA-617	85928	ASH-25822	89414	ASH24661	83317	FC44-18080-AB	85180
AA616	83175	ASH-25823	83209	ASH25820	85005	FC4418045BB	85181
AA617	85928	ASH-25823	89414	ASH25820	89430	FC4418080AB	85180
ASH-1022	83209	ASH-25824	83122	ASH25821	85006	FC4Z-18124-A	85181
ASH-1022	89414	ASH-25824	89406	ASH25822	83209	FC4Z-18124-B	85181
ASH-1023	83122	ASH-294	83209	ASH25822	89414	FC4Z-18125-A	85180
ASH-1023	89406	ASH-294	89414	ASH25823	83209	FC4Z18124A	85181
ASH-1136	G63623	ASH1022	83209	ASH25823	89414	FC4Z18124B	85181
ASH-1154	G63622	ASH1022	89414	ASH25824	83122	FC4Z18125A	85180
ASH-1161	85006	ASH1023	83122	ASH25824	89406	SDA471700002809	85724
ASH-1162	85005	ASH1023	89406	ASH294	83209	SDA471700002809	89443

Gillig Bros

Gillig Bros	Gabriel	Gillig Bros	Gabriel	Gillig Bros	Gabriel	Gillig Bros	Gabriel
1145291N000	89430	82-21542-000	85716	90044046	83123	9051024	89430
57131	83216	8201878	83122	90044046	89405		
82-01878	83122	8201878	89406	90044683	83122		
82-01878	89406	8221542000	85716	90044683	89406		

Glaval Bus Co

Glaval Bus Co	Gabriel	Glaval Bus Co	Gabriel	Glaval Bus Co	Gabriel	Glaval Bus Co	Gabriel
3578858C1	85656	4C4Z-18125-DA	85656	ASH-1154	G63622	FC44-18080-AB	85180
3578858C2	85656	4C4Z18124JB	85928	ASH-24658	85181	FC4418045BB	85181
3584116C1	83175	4C4Z18124QA	83175	ASH-24659	85181	FC4418080AB	85180
3584116C2	83175	4C4Z18124RA	85928	ASH-24660	85180	FC4Z-18124-A	85181
3584118C2	85928	4C4Z18125DA	85656	ASH24658	85181	FC4Z-18124-B	85181
471700011530	85181	501906C92	83317	ASH24659	85181	FC4Z-18125-A	85180
471700011531	85180	AA-616	83175	ASH24660	85180	FC4Z18124A	85181
4C4Z-18124-JB	85928	AA-617	85928	ASH24661	83317	FC4Z18124B	85181
4C4Z-18124-QA	83175	AA616	83175	AT-812	85928	FC4Z18125A	85180
4C4Z-18124-RA	85928	AA617	85928	AT812	85928		
4C4Z-18125-B	83317	ASH-1136	G63623	FC44-18045-BB	85181		

Gold

Gold	Gabriel	Gold	Gabriel	Gold	Gabriel	Gold	Gabriel
5000738	85071	5000745	89414	5000764	85957	5000778	83054
5000741	83136	5000747	83101	5000765	83216		
5000742	83308	5000748	83135	5000776	85005		
5000745	83314	5000759	83142	5000776	89430		
5000745	85013	5000762	83160	5000777	83143		

Important Note: Competitive Interchanges are to be used for stocking purposes only. Where multiple crosses are identified, please reference the applications section of this catalog. / **Remarque importante:** Les interchanges concurrentiels ne s'utilisent qu'aux fins de stocks. Dans le cas de références multiples, consulter la section des applications du catalogue. / **Nota importante:** Dans le cas de références multiples, consulter la section des applications du catalogue. / **Nota importante:** Se pueden usar intercambios competitivos para propósitos de almacenamiento solamente. Cuando se identifican intercambios múltiples, consulte la sección de aplicaciones de este catálogo.

COMPETITIVE & O.E.M. INTERCHANGE LIST
Lista de Intercambios contra Competidores y Equipo Original.
Liste d'interchange de produits compétitifs & déquippement original (OEM)

Gold... cont'd

Gold	Gabriel	Gold	Gabriel	Gold	Gabriel	Gold	Gabriel
5000781	85656	8150372	83137	8160935	83140	9170007	85918
5000783	83025	8160091	85006	8180172	85919	9170007	89449
5000785	83216	8160098	83456	9150063	83216	9180126	85012
5000786	83103	8160098	89447	9160091	85006	9180126	89413
5000790	83180	8160102	83215	9160092	85043	9180130	85005
5000791	83157	8160103	83312	9160093	83317	9180130	89430
5000792	83134	8160103	89409	9160268	85058	9180134	85921
5000808	89430	8160113	89458	9160268	89431	9180143	85918
5000813	83221	8160114	85918	9160488	83456	9180143	89449
5000816	85956	8160114	89449	9160488	89447	9180147	83136
5000818	83120	8160115	85031	9160493	83136	9180149	85900
5000825	83225	8160116	85012	9160498	83136	9180153	89458
5000826	85029	8160116	89413	9160513	85029	9180184	83163
5000830	83175	8160118	85900	9160536	85005	9180187	85084
5000839	83131	8160119	85902	9160536	89430	9180187	89460
5000840	83162	8160120	85069	9160545	83154	9180188	85069
5000853	83101	8160120	89455	9160697	G63622	9180188	89455
5000855	83154	8160195	85013	9160761	G63461	9180190	85072
5000856	85978	8160195	85043	9160820	83312	9180196	83122
5000861	83025	8160195	89414	9160820	89409	9180196	89406
5000862	83140	8160523	83021	9160933	83209	9190007	85724
5000869	83216	8160907	89405	9160933	89414	9190007	89443
5000871	83164	8160909	83123	9160972	83025		
8150371	83127	8160909	89405	9160980	83135		

Goshen Coach

Goshen Coach	Gabriel	Goshen Coach	Gabriel	Goshen Coach	Gabriel	Goshen Coach	Gabriel
ASH-1136	G63623	ASH-1154	G63622	ASH1136	G63623	ASH1154	G63622

Granning Suspension

Granning Suspension	Gabriel	Granning Suspension	Gabriel	Granning Suspension	Gabriel	Granning Suspension	Gabriel
12887-01	85013	1682401	85006	17408-01	85005	19495-01	89430
12887-01	89414	17146-01	83209	17408-01	89430	1949501	83126
12887-02	85013	17146-01	89414	1740801	85005	1949501	89430
12887-02	89414	1714601	83209	1740801	89430	19623-01	83123
1288701	85013	1714601	89414	17794-01	83215	19623-01	89405
1288701	89414	17358-01	83126	1779401	83215	1962301	83123
1288702	85013	17358-01	89430	18164-01	83122	1962301	89405
1288702	89414	1735801	83126	18164-01	89406	19824-01	85006
16725-01	83126	1735801	89430	1816401	83122	1982401	85006
16725-01	89430	17403-01	83122	1816401	89406	21497-01	85005
1672501	83126	17403-01	89406	18165-01	85006	21497-01	89430
1672501	89430	1740301	83122	1816501	85006	2149701	85005
16824-01	85006	1740301	89406	19495-01	83126	2149701	89430

Great Dane Trailer

Great Dane Trailer	Gabriel	Great Dane Trailer	Gabriel	Great Dane Trailer	Gabriel	Great Dane Trailer	Gabriel
18164-01	83122	1816401	89406	MER202447	85919		
18164-01	89406	18165-01	85006	REY18165-01	85006		
1816401	83122	1816501	85006	REY1816501	85006		

Grech Motors

Grech Motors	Gabriel	Grech Motors	Gabriel	Grech Motors	Gabriel	Grech Motors	Gabriel
ASH-1136	G63623	ASH-1154	G63622				

GROB

GROB	Gabriel	GROB	Gabriel	GROB	Gabriel	GROB	Gabriel
2709049	81496	6109001	G64089	G2419	G63492	G5092	G63896
2709071	G64121	6109005	G64089	G5034	G63366		
3009024	77948	6109007	G63918	G5054	G63888		
3009025	G64042	6109008	G56778	G5091	G63489		
4009025	G63969	6709037	81147	G5092	G63488		

Important Note: Competitive Interchanges are to be used for stocking purposes only. Where multiple crosses are identified, please reference the applications section of this catalog. / **Remarque importante:** Les interchanges concurrentiels ne s'utilisent qu'aux fins de stocks. Dans le cas de références multiples, consulter la section des applications du catalogue. / **Nota importante:** Dans le cas de références multiples, consulter la section des applications du catalogue. / **Nota importante:** Se pueden usar intercambios competitivos para propósitos de almacenamiento solamente. Cuando se identifican intercambios múltiples, consulte la sección de aplicaciones de este catálogo.

COMPETITIVE & O.E.M. INTERCHANGE LIST
Lista de Intercambios contra Competidores y Equipo Original.
Liste d'interchange de produits compétitifs & déquippement original (OEM)

GROB... cont'd

GROB	Gabriel	GROB	Gabriel	GROB	Gabriel	GROB	Gabriel
G5099	61523	G5133	G63609	G5206	61641	G5837	G63837
G5100	61600	G5169	G63817	G5213	61655	G5838	G63809
G5101	G63674	G5174	G63489	G5232	81744		
G5107	G63622	G5190	G63622	G5234	G63492		
G5115	61646	G5196	G63403	G5235	G63299		

Grupo A

Grupo A	Gabriel	Grupo A	Gabriel	Grupo A	Gabriel	Grupo A	Gabriel
15500	6802SE	53019	83456	53338	82003	69025	81147
15501	6804SE	53019	89447	53341	61521	69040	61506
15502	6804SE	53020	61521	53341	81394	69040	81318
164023	43140	53020	81394	53400	61523	69043	61506
39155	49155	53020	81744	53400	81096	69043	81318
39205	49205	53021	G63623	53401	81091	69078	G63492
39218	49231	53024	85005	53402	G63360	69080	61506
43003	61524	53025	61521	58003	61524	69080	81318
43003	81164	53025	81394	58003	81164	69300	G63349
43004	G63366	53026	85005	58004	G63366	69309	58929
43014	81340	53028	G63489	58012	89425	69309	61520
43025	61519	53029	61544	58034	85013	69309	81490
43025	81484	53029	81668	58034	89414	69309	81744
43026	81676	53035	G63488	58035	58488	69310	81490
43046	61500	53036	81091	58035	61543	69310	81744
43046	81147	53037	61565	58035	81667	69321	61500
43059	61500	53039	85006	58041	83456	69321	81147
43059	81147	53040	85006	58041	89447	69326	61500
43066	83309	53042	83309	58048	83137	69326	81147
43069	81710	53043	83215	58054	61530	69330	81710
43070	61520	53051	61520	58054	81510	69346	81091
43070	81490	53051	81490	58056	83137	69347	G63355
43119	61600	53052	61530	58057	83456	69355	61523
43120	61641	53052	81510	58057	89447	69355	81096
43121	81920	53053	G63386	58058	85031	69355	81834
43122	61600	53057	G63359	58059	85005	69357	81091
43122	81873	53058	G63353	58059	89430	69361	61614
43124	61500	53061	G63413	58061	83122	69369	81147
43124	81147	53063	83025	58061	89406	69381	61500
43125	61520	53065	83136	58069	61547	69381	81147
43125	81490	53069	81710	58069	81082	69382	81342
43132	61554	53070	61520	58070	61520	69383	61632
43132	81710	53070	81490	58070	81490	69383	81825
43133	61554	53071	61519	58178	61500	69395	61520
43133	81710	53071	81484	58178	81147	69395	81490
43139	83021	53072	81925	58337	58489	69396	61547
43145	83021	53081	83159	58337	61544	69396	81082
43158	G63183	53082	83515	58337	81668	69500	83122
43236	61524	53083	83159	58341	61521	69500	89406
43236	81164	53084	83515	58341	81394	69501	61543
43381	61521	53091	83159	58400	G63359	69503	61544
43381	81394	53195	G63183	58401	G63353	69505	61506
43511	81091	53271	G63673	69011	61600	69506	61523
43512	81091	53272	G63662	69012	61641	69507	G63353
43731	61614	53273	G63674	69013	61641	69509	61554
43731	81821	53274	G63675	69013	81920	69510	61520
53004	G63366	53275	G63661	69014	61600		
53010	83136	53276	81873	69014	81873		
53013	85071	53337	61544	69017	G63409		
53018	83317	53337	81668	69024	61500		

Important Note: Competitive Interchanges are to be used for stocking purposes only. Where multiple crosses are identified, please reference the applications section of this catalog. / **Remarque importante:** Les interchanges concurrentiels ne s'utilisent qu'aux fins de stocks. Dans le cas de références multiples, consulter la section des applications du catalogue. / **Nota importante:** Dans le cas de références multiples, consulter la section des applications du catalogue. / **Nota importante:** Se pueden usar intercambios competitivos para propósitos de almacenamiento solamente. Cuando se identifican intercambios múltiples, consulte la sección de aplicaciones de este catálogo.

COMPETITIVE & O.E.M. INTERCHANGE LIST
Lista de Intercambios contra Competidores y Equipo Original.
Liste d'interchange de produits compétitifs & équipement original (OEM)

Grupo A... cont'd

Grupo A	Gabriel	Grupo A	Gabriel	Grupo A	Gabriel	Grupo A	Gabriel
69511	G63299	69622	61642	69753	85031	USA69080	61506
69519	61599	69623	61635	72009	G64089	USA69080	81318
69520	61544	69651	G63488	72020	G64043	USA69522	61544
69521	61543	69653	58488	72033	G63614	USA69538	61683
69522	G63638	69663	61555	72039	G63886	USA69539	61684
69523	61544	69664	61565	78001	89425	USA69544	G63622
69538	61683	69666	61655	78015	85724	USA69587	61710
69539	61684	69668	G63918	78015	89443	USA69588	G63971
69544	G63622	69669	83123	78023	85705	USA69592	61714
69546	61591	69669	85010	78023	89447	USA69594	61713
69548	61520	69669	89405	78025	85009	USA69601	61554
69548	81490	69671	85006	78027	89425	USA69664	61565
69548	81744	69672	85043	78039	85311	USA69666	61655
69549	58929	69673	83209	78039	89424	USA69668	G63918
69549	61591	69673	89414	79103	G56778	USA69689	83127
69550	61518	69678	G63674	79132	G56778	USA69692	61663
69550	81242	69679	G63675	79319	G64148	USA69699	61500
69554	61554	69685	83136	USA53094	83137	USA69749	85013
69557	G63662	69692	61663	USA58017	83164	USA69756	85957
69563	61634	69705	83122	USA58073	85084	USA69759	83148
69587	61710	69705	89406	USA58080	85932	USA72035	G64042
69588	G63971	69712	85013	USA58082	85932	USA78031	85311
69592	61714	69712	89414	USA69011	G63662	USA78051	85918
69593	61654	69729	89425	USA69012	G63783	USA79103	G56778
69594	61713	69745	85058	USA69013	61641	USA79132	G56778
69601	61554	69745	89431	USA69013	81920		
69611	G63403	69746	83137	USA69014	61600		
69616	G63607	69750	89425	USA69014	81873		

GSP

GSP	Gabriel	GSP	Gabriel	GSP	Gabriel	GSP	Gabriel
812005	G57206	812009	G57206	812228	G57206		
812006	G57206	812010	G57206				

Gulf Stream Coach

Gulf Stream Coach	Gabriel	Gulf Stream Coach	Gabriel	Gulf Stream Coach	Gabriel	Gulf Stream Coach	Gabriel
141700131809	85029	16-18103-000	85900	88982682	83136	ASH-1136	G63623
141700131810	83160	1616736000	85029	8C24-18045-DA	G63622	ASH-1154	G63622
15123676	83136	1616737000	83160	8C24-18080-DB	G63623	ASH1136	G63623
15588554	83136	1616873000	85029	8C2418045DA	G63622	ASH1154	G63622
15887728	83136	1616874000	83160	8C2418080DB	G63623	AT-163G	G63622
16-16736-000	85029	1618103000	85900	8C2Z-18124-D	G63622	AT-164G	G63623
16-16737-000	83160	19152843	83136	8C2Z-18125-D	G63623	AT163G	G63622
16-16873-000	85029	22064230	83136	8C2Z18124D	G63622	AT164G	G63623
16-16874-000	83160	481700000493	85900	8C2Z18125D	G63623		

Hendrickson

Hendrickson	Gabriel	Hendrickson	Gabriel	Hendrickson	Gabriel	Hendrickson	Gabriel
060675-016	85976	47902-19	89405	47902-8	89406	4790227	83123
060675016	85976	47902-20	89405	47902-9	83123	4790227	89405
12738	83225	47902-21	85976	47902-9	89405	4790228	85013
471700006269	85932	47902-22	89430	4790213	83122	4790228	89414
471700006269	89453	47902-24	83137	4790213	89406	479023	85005
471700006270	85932	47902-27	83123	4790215	83137	479023	89430
471700006270	89453	47902-27	89405	4790219	83123	479028	83122
471700131545	85006	47902-28	85013	4790219	89405	479028	89406
47902-13	83122	47902-28	89414	4790220	89405		
47902-13	89406	47902-3	85005	4790221	85976		
47902-15	83137	47902-3	89430	4790222	89430		
47902-19	83123	47902-8	83122	4790224	83137		

Important Note: Competitive Interchanges are to be used for stocking purposes only. Where multiple crosses are identified, please reference the applications section of this catalog. / **Remarque importante:** Les interchanges concurrentiels ne s'utilisent qu'aux fins de stocks. Dans le cas de références multiples, consulter la section des applications du catalogue. / **Nota importante:** Dans le cas de références multiples, consulter la section des applications du catalogue. / **Nota importante:** Se pueden usar intercambios competitivos para propósitos de almacenamiento solamente. Cuando se identifican intercambios múltiples, consulte la sección de aplicaciones de este catálogo.

COMPETITIVE & O.E.M. INTERCHANGE LIST
Lista de Intercambios contra Competidores y Equipo Original.
Liste d'interchange de produits compétitifs & déquippement original (OEM)

Hendrickson... cont'd

Hendrickson	Gabriel	Hendrickson	Gabriel	Hendrickson	Gabriel	Hendrickson	Gabriel
479029	83123	60665-005	85919	6067012	83168	659004	83123
479029	89405	60665-005L	85919	60675-001	85978	659004	89405
57324-1	89405	60665-008	85978	60675-001L	85978	659048	83143
57324-2	85976	60665-009	85043	60675-002	85979	659049	83142
57324-3	89430	60665-020	85919	60675-002L	85979	659202	83148
57324-6	85043	60665-025	89405	60675-003	85976	659292	83148
573241	89405	60665-025L	89405	60675-003L	85976	665190	85006
573242	85976	60665003	83137	60675-004	85006	665246	85043
573243	89430	60665004	89405	60675-007	83122	665267	85029
573246	85043	60665004L	89405	60675-007	89406	665406	85010
57905-1	85976	60665005	85919	60675-009	85978	665532	85013
57905-2	85006	60665005L	85919	60675-010	89405	665532	89414
579051	85976	60665008	85978	60675-013	83123	665533	85005
579052	85006	60665009	85043	60675-013	89405	665533	89430
58623-1	85978	60665020	85919	60675-014	85978	665764	85029
586231	85978	60665025	89405	60675-017	85979	665816	85072
58913-003	85932	60665025L	89405	60675001	85978	665892	85072
58913-003	89453	60670-001	83123	60675001L	85978	671006	89405
58913-003L	85932	60670-001	89405	60675002	85979	671007	83137
58913-003L	89453	60670-004	83123	60675002L	85979	671009	85919
58913-012	85932	60670-004	89405	60675003	85976	671105	85072
58913-012	89453	60670-005	83137	60675003L	85976	671603	85919
58913-012L	85932	60670-008	83123	60675004	85006	671704	85043
58913-012L	89453	60670-008	89405	60675007	83122	671779	89414
58913003	85932	60670-008L	83123	60675007	89406	680616	89430
58913003	89453	60670-008L	89405	60675009	85978	98583-005	83168
58913003L	85932	60670-009	85013	60675010	89405	98583-006	83148
58913003L	89453	60670-009	89414	60675013	83123	98583-020	89414
58913012	85932	60670-011	83148	60675013	89405	98583-032	85072
58913012	89453	60670-012	83168	60675014	85978	98583005	83168
58913012L	85932	60670-013	83148	60675017	85979	98583006	83148
58913012L	89453	60670-014	83166	606758Q	85976	98583032	85072
59048-001	83148	60670-017	83148	60680-004	83143	A-10348	85043
59048001	83148	60670-018	83166	60680-004L	83143	A-20887	85005
59057-001	83137	60670-019	83166	60680-005	83142	A-20887	89430
59057-002	89405	60670-020	83148	60680-005L	83142	A-2212	85029
59057001	83137	60670-12	83168	60680004	83143	A-2213	85010
59057002	89405	60670001	83123	60680004L	83143	A-2230	85005
59305-1	85979	60670001	89405	60680005	83142	A-2230	89430
593051	85979	60670004	83123	60680005L	83142	A-2232	85005
59483-000	85919	60670004	89405	60998-001	85006	A-2232	89430
59483000	85919	60670005	83137	60998-002	85919	A-2240	85013
59851-1	85976	60670008	83123	60998-002L	85919	A-2240	89414
598511	85976	60670008	89405	60998-003	85006	A-2240-1	85043
60657-003	85072	60670008L	83123	60998001	85006	A-2471	85006
60657-003L	85072	60670008L	89405	60998002	85919	A-4084	85005
60657-004	85072	60670009	85013	60998002L	85919	A-4084	89430
60657-007	85072	60670009	89414	60998003	85006	A-4089	83209
60657-017	85979	60670011	83148	654894	83123	A-4089	89414
60657003	85072	60670012	83168	654894	89405	A10348	85043
60657003L	85072	60670013	83148	654895	83137	A20887	85005
60657004	85072	60670014	83166	654898	83123	A20887	89430
60657007	85072	60670017	83148	654898	89405	A2212	85029
60665-003	83137	60670018	83166	654899	85013	A2213	85010
60665-004	89405	60670019	83166	654899	89414	A2230	85005
60665-004L	89405	60670020	83148	659000	83148	A2230	89430

Important Note: Competitive Interchanges are to be used for stocking purposes only. Where multiple crosses are identified, please reference the applications section of this catalog. / **Remarque importante:** Les interchanges concurrentiels ne s'utilisent qu'aux fins de stocks. Dans le cas de références multiples, consulter la section des applications du catalogue. / **Nota importante:** Dans le cas de références multiples, consulter la section des applications du catalogue. / **Nota importante:** Se pueden usar intercambios competitivos para propósitos de almacenamiento solamente. Cuando se identifican intercambios múltiples, consulte la sección de aplicaciones de este catálogo.

COMPETITIVE & O.E.M. INTERCHANGE LIST
Lista de Intercambios contra Competidores y Equipo Original.
Liste d'interchange de produits compétitifs & équipement original (OEM)

Hendrickson... cont'd

Hendrickson	Gabriel	Hendrickson	Gabriel	Hendrickson	Gabriel	Hendrickson	Gabriel
A2232	85005	B23315	85029	S-2232	89430	S2213	85010
A2232	89430	B25174	85029	S-2240	85013	S2230	85005
A2240	85013	B25436	89430	S-2240	89414	S2230	89430
A2240	89414	BE76164-4	83225	S-23315	85029	S2232	85005
A22401	85043	BE761644	83225	S-2471	85006	S2232	89430
A2471	85006	NS500699	85005	S-25436	89430	S2240	85013
A4084	85005	NS500699	89430	S-4084	85005	S2240	89414
A4084	89430	S-10348	85043	S-4084	89430	S23315	85029
A4089	83209	S-20887	85005	S-4089	83209	S2471	85006
A4089	89414	S-20887	89430	S-4089	89414	S25436	89430
AE76164-4	83225	S-2212	85029	S10348	85043	S4084	85005
AE761644	83225	S-2213	85010	S20887	85005	S4084	89430
B-23315	85029	S-2230	85005	S20887	89430	S4089	83209
B-25174	85029	S-2230	89430	S2212	85029	S4089	89414
B-25436	89430	S-2232	85005	S2212HDR	85029		

Hino

Hino	Gabriel	Hino	Gabriel	Hino	Gabriel	Hino	Gabriel
34802	83216	4851180162	83518	48531-37362	83519	60670014L	83166
48500-1800	83216	48530-1460	83215	4853137350	83519	60670018	83166
48500-1801	83216	48530-1770	83215	4853137351	83519	60670018L	83166
48500-1940	83141	48530-1880	83215	4853137361	83519	60670019	83166
48500-1941	83141	48530-1910	83216	4853137362	83519	60670019L	83166
48500-1950	G63610	48530-2510	83216	60670-012	83168	60670020	83148
48500-2750	G63610	48530-E0100	83166	60670-013	83148	60670029L	83166
48500-3710	83126	48530-E0250	83137	60670-014	83166	60670030	83166
48500-3710	89430	48530-E0290	83166	60670-014L	83166	60670030L	83166
48500-3720	83140	48530-E0390	83166	60670-018	83166	60670031L	83166
48500-E0420	83391	48530-EW040	83166	60670-018L	83166	66639	G63610
485001800	83216	485301460	83215	60670-019	83166	S4850-01941	83141
485001940	83141	485301770	83215	60670-019L	83166	S4850-01950	G63610
485001941	83141	485301880	83215	60670-020	83148	S4850-02750	G63610
485003710A	83126	48530E0100	83166	60670-029L	83166	S4850-03710	83126
485003710A	89430	48530E0250	83137	60670-030	83166	S4850-03710	89430
485003720	83140	48530E0290	83166	60670-030L	83166	S4850-03720	83140
48500E0420	83391	48530E0390	83166	60670-031L	83166	S485001941	83141
48511-37320	83518	48531-37350	83519	60670012	83168	S485003720	83140
48511-80162	83518	48531-37351	83519	60670013	83148	S4853-01910	83216
4851137320	83518	48531-37361	83519	60670014	83166	S4853-02510	83216

Holiday Rambler

Holiday Rambler	Gabriel	Holiday Rambler	Gabriel	Holiday Rambler	Gabriel	Holiday Rambler	Gabriel
01809923	85029	8C24-18080-DB	G63623	9U9Z-18124-A	89414	ASH-1205	89414
01809925	85010	8C2418045DA	G63622	9U9Z-18125-A	83122	ASH-1206	83122
1C34-18045-AA	83209	8C2418080DB	G63623	9U9Z-18125-A	89406	ASH-1206	89406
1C34-18045-AA	89414	8C2Z-18124-D	G63622	9U9Z18124A	83209	ASH-1228	83209
1C34-18045-JA	83209	8C2Z-18125-D	G63623	9U9Z18124A	89414	ASH-1228	89414
1C34-18045-JA	89414	8C2Z18124D	G63622	9U9Z18125A	83122	ASH-1229	83209
1C3418045AA	83209	8C2Z18125D	G63623	9U9Z18125A	89406	ASH-1229	89414
1C3418045AA	89414	90044794	83127	ASH-1022	83209	ASH-1230	83122
1C3418045JA	83209	9U94-18045-AA	83209	ASH-1022	89414	ASH-1230	89406
1C3418045JA	89414	9U94-18045-AA	89414	ASH-1023	83122	ASH-137	83122
24-153249	85125	9U94-18080-AA	83122	ASH-1023	89406	ASH-137	89406
24-153256	85124	9U94-18080-AA	89406	ASH-1136	G63623	ASH-25820	85005
24-186629	85125	9U9418045AA	83209	ASH-1154	G63622	ASH-25820	89430
24153249	85125	9U9418045AA	89414	ASH-1161	85006		
24153256	85124	9U9418080AA	83122	ASH-1162	85005		
24186629	85125	9U9418080AA	89406	ASH-1162	89430		
8C24-18045-DA	G63622	9U9Z-18124-A	83209	ASH-1205	83209		

Important Note: Competitive Interchanges are to be used for stocking purposes only. Where multiple crosses are identified, please reference the applications section of this catalog. / **Remarque importante:** Les interchanges concurrentiels ne s'utilisent qu'aux fins de stocks. Dans le cas de références multiples, consulter la section des applications du catalogue. / **Nota importante:** Dans le cas de références multiples, consulter la section des applications du catalogue. / **Nota importante:** Se pueden usar intercambios competitivos para propósitos de almacenamiento solamente. Cuando se identifican intercambios múltiples, consulte la sección de aplicaciones de este catálogo.

COMPETITIVE & O.E.M. INTERCHANGE LIST
Lista de Intercambios contra Competidores y Equipo Original.
Liste d'interchange de produits compétitifs & déquippement original (OEM)

Holiday Rambler... cont'd

Holiday Rambler	Gabriel	Holiday Rambler	Gabriel	Holiday Rambler	Gabriel	Holiday Rambler	Gabriel
ASH-25821	85006	ASH1205	83209	ASH25823	89414	AT621	89406
ASH-25822	83209	ASH1205	89414	ASH25824	83122	AT766	83209
ASH-25822	89414	ASH1206	83122	ASH25824	89406	AT766	89414
ASH-25823	83209	ASH1206	89406	ASH294	83209	F4-BE5-A832-MO	85125
ASH-25823	89414	ASH1228	83209	ASH294	89414	F4-BE5-B492-HO	85125
ASH-25824	83122	ASH1228	89414	AT-163G	G63622	F4-BE5-F324-HO	85125
ASH-25824	89406	ASH1229	83209	AT-164G	G63623	F4-BE5-F325-HO	85124
ASH-294	83209	ASH1229	89414	AT-620	83209	F4BE5A832MO	85125
ASH-294	89414	ASH1230	83122	AT-620	89414	F4BE5B492HO	85125
ASH1022	83209	ASH1230	89406	AT-621	83122	F4BE5F324HO	85125
ASH1022	89414	ASH137	83122	AT-621	89406	F4BE5F325HO	85124
ASH1023	83122	ASH137	89406	AT-766	83209	U0109-007	G63183
ASH1023	89406	ASH25820	85005	AT-766	89414	U0109007	G63183
ASH1136	G63623	ASH25820	89430	AT163G	G63622	W0005662	85125
ASH1154	G63622	ASH25821	85006	AT164G	G63623	W0005663	85124
ASH1161	85006	ASH25822	83209	AT620	83209	W0006254	85125
ASH1162	85005	ASH25822	89414	AT620	89414		
ASH1162	89430	ASH25823	83209	AT621	83122		

IC Corporation

IC Corporation	Gabriel	IC Corporation	Gabriel	IC Corporation	Gabriel	IC Corporation	Gabriel
1660846C92	83101	3605735C1	83169	3902993C3	83135	537524C91	89405
2200327C1	85332	3605735C2	83169	472412C91	83456	6127088C1	83163
3533356C3	83169	3609400C1	83317	472412C91	89447	6127713C1	85656
3578105C1	83163	3609400C2	83317	501906C91	83317	6127713C2	85656
3578105C2	83163	3902993C1	83135	501906C92	83317	OE13402S	83163
3578858C2	85656	3902993C2	83135	537524C91	83123	OE13424S	83317

International

International	Gabriel	International	Gabriel	International	Gabriel	International	Gabriel
1201-1043	83025	1667520C1	89431	306444C91	85012	3549099C2	89458
1201-1044	83025	2029200C91	83126	306444C91	89413	3549099C3	89458
1201-1049	83025	2029200C91	89430	3085640C92	83216	3549100C1	85656
1201-9007	83054	204994R91	83225	308646C91	85012	3553628C1	85927
1201-9008	83054	206620R91	83216	308646C91	89413	3553628C2	85927
1201-9009	83054	206621R91	83216	308648C91	83225	3553628C3	85927
12011043	83025	206621R92	83216	308649C91	83216	3553628C4	85927
12011044	83025	210533R91	83225	308650C91	83216	3560705C2	83054
12011049	83025	210534R92	83225	308650C92	83216	3573265C1	89458
12019007	83054	210535R91	83225	308668C91	85012	3576464C1	85957
12019008	83054	210536R91	83225	308668C91	89413	3576464C2	85957
12019009	83054	210537R91	83225	308668C92	85012	3578105C1	83163
1202-0042	83025	210538R91	83225	308668C92	89413	3578105C2	83163
1202-0043	83025	210918R91	83215	308669C91	85012	3578858C1	85656
1202-0044	83025	2200327C1	85332	308669C91	89413	3578858C2	85656
1202-0054	83021	2503529C1	83025	320444C91	85012	3584116C1	83175
1202-1043	83025	2507948C1	83054	320444C91	89413	3584116C2	83175
1202-1044	83025	2508326C1	83021	329316C92	85012	3584117C1	83135
12020042	83025	2508327C1	83025	329316C92	89413	3584117C2	83135
12020043	83025	2509221C91	83054	3514952C1	85976	3584118C1	85928
12020044	83025	2509223C91	83054	3533356C1	83135	3584118C2	85928
12020054	83021	2509223C92	83054	3533356C2	83135	3586883C1	89458
12021043	83025	288920C91	83225	3533356C3	83169	3586902C2	83364
12021044	83025	288921C91	83225	3533357C1	85957	3586902C3	83364
1660846C91	83101	288921R92	83225	3533357C2	85957	3588209C1	85957
1660846C92	83101	294334C91	83216	3533357C3	85957		
1663471C1	83103	3000070C91	83456	3544768C1	85656		
1664149C1	85029	3000070C91	89447	3544768C2	85656		
1667520C1	85058	3000098C1	83317	3549099C1	89458		

Important Note: Competitive Interchanges are to be used for stocking purposes only. Where multiple crosses are identified, please reference the applications section of this catalog. / **Remarque importante:** Les interchanges concurrentiels ne s'utilisent qu'aux fins de stocks. Dans le cas de références multiples, consulter la section des applications du catalogue. / **Nota importante:** Dans le cas de referencias multiples, consultar la section des applications du catalogue. / **Nota importante:** Se pueden usar intercambios competitivos para propósitos de almacenamiento solamente. Cuando se identifican intercambios múltiples, consulte la sección de aplicaciones de este catálogo.

COMPETITIVE & O.E.M. INTERCHANGE LIST
Lista de Intercambios contra Competidores y Equipo Original.
Liste d'interchange de produits compétitifs & équipement original (OEM)

International... cont'd

International	Gabriel	International	Gabriel	International	Gabriel	International	Gabriel
3588209C2	85957	4164149C1	89458	472411C91	89447	6127088C1	83163
3596107C1	85927	4164155C1	85058	472412C91	83456	6127096C1	83180
3596107C2	85927	4164155C1	89431	472412C91	89447	6127666C1	85642
3596107C3	85927	4205983C1	83397	474002C91	83308	6127688C1	83169
3596107C4	85927	4206863C1	83398	47902-24	83137	6127690C1	89458
360444C91	85012	4207304C1	83397	4790224	83137	6127700C1	83395
360444C91	89413	4208946C1	83398	4C4Z-18124-N	85957	6127704C1	85670
3606770C1	83163	4211080C1	85957	4C4Z-18125-DA	85656	6127713C1	85656
3606770C2	83163	4212932C1	89458	4C4Z18124N	85957	6127713C2	85656
3609400C1	83317	4213760C1	83163	4C4Z18125DA	85656	6127714C1	85928
3609400C2	83317	4214011C2	85670	501506C91	83317	6ETZ-18125-A	83364
3620395C1	89458	452566C91	83225	501906C91	83317	6ETZ18125A	83364
3626571C1	85072	453527C91	85311	501906C92	83317	790335C91	83209
3626571C2	85072	453527C91	89424	537524C91	83123	790335C91	89414
3688614C1	89458	453528C91	85311	537524C91	89405	873619C92	83314
3688615C1	89458	453528C91	89424	537525C91	83123	873619C93	83314
3688616C1	89458	453556C91	85012	537525C91	89405	873622C91	83308
3688729C1	89458	453556C91	89413	540395C91	83613	874695R91	85012
3688732C1	89458	453561C91	83225	540395C92	83613	874695R91	89413
3737576C1	89458	453562C91	83225	548532C1	83103	874695R92	85012
3821760C1	89458	453564C91	85012	56101 Z1030	85311	874695R92	89413
383379C91	83308	453564C91	89413	56101 Z1030	89424	874696R91	85012
384435C91	83216	453565C91	83225	56101 Z2000	85311	874696R91	89413
3885832C1	83135	453566C91	83225	56101 Z2000	89424	90044025	83209
3885832C2	83135	453567C91	83216	56101 Z5008	83114	90044025	89414
3892445C3	89458	453568C91	83225	56101 Z5011	G63610	90044626	83126
3892458C1	85656	453569C91	83225	57905-001	85976	90044626	89430
3892458C2	85656	453570C91	83216	57905001	85976	AMS600102	85005
3902993C1	83135	453571C91	83216	586724C91	83456	AMS600102	89430
3902993C3	83135	453572C91	83309	586724C91	89447	AMS600172	83126
3914952C1	85976	453575C91	83308	60657-003	85072	AMS600172	85005
3945165C1	83180	462603C91	85705	60657-003L	85072	AMS600172	89430
3989717C1	83135	462603C91	89447	60657003	85072	AMS650402	85311
3991991C1	83135	462753C91	83216	60657003L	85072	AMS650402	89424
4050340C1	89458	463926C91	85705	60675-003	85976	AMS650420	85013
4050340C2	89458	463926C91	89447	60675-003L	85976	AMS650420	89414
4069426C1	85642	467371C91	83225	60675003	85976	H60657-003	85072
4069434C1	85642	467372C91	83225	60675003L	85976	H60657003	85072
4069435C1	85642	467983C91	85012	60680-004	83143	H60675-003	85976
4070336C1	85058	467983C91	89413	60680-004L	83143	H60675003	85976
4070336C1	89431	467984C91	83216	60680-005	83142	H60680004	83143
4072186C1	85928	467985C91	85012	60680-005L	83142	HDR60680-005	83142
4089293C1	83397	467985C91	89413	60680004	83143	HDR60680005	83142
4109458C2	83243	471201C91	85012	60680004L	83143	OE 18513	83135
4109582C1	83397	471201C91	89413	60680005	83142	OE13402S	83163
4109583C1	83397	471203C91	83308	60680005L	83142	OE13424S	83317
4164146C1	83169	472411C91	83456	6127087C1	83364	OE17103	83135

Isuzu

Isuzu	Gabriel	Isuzu	Gabriel	Isuzu	Gabriel	Isuzu	Gabriel
1-51630-160-0	83162	12474915	83122	15887728	83136	51630666	85012
1-51630-167-0	83613	12474915	89406	19152843	83136	51630666	89413
1-51630-168-1	83515	15123676	83136	5002465	83166	5872000750	83159
1-51630-217-0	83114	1516301600	83162	51630168	83515	5872001100	83515
1-51630-217-1	83114	1516301670	83613	51630217	83114	60670-005	83137
1-51630-219-0	83114	1516301681	83515	51630219	83114	60670-005L	83137
1-51630-219-1	83114	15174902	85071	51630647	83515	60670005	83137

Important Note: Competitive Interchanges are to be used for stocking purposes only. Where multiple crosses are identified, please reference the applications section of this catalog. / **Remarque importante:** Les interchanges concurrentiels ne s'utilisent qu'aux fins de stocks. Dans le cas de références multiples, consulter la section des applications du catalogue. / **Nota importante:** Dans le cas de références multiples, consulter la section des applications du catalogue. / **Nota importante:** Se pueden usar intercambios competitivos para propósitos de almacenamiento solamente. Cuando se identifican intercambios múltiples, consulte la sección de aplicaciones de este catálogo.

COMPETITIVE & O.E.M. INTERCHANGE LIST
Lista de Intercambios contra Competidores y Equipo Original.
Liste d'interchange de produits compétitifs & déquippement original (OEM)

Isuzu... cont'd

Isuzu	Gabriel	Isuzu	Gabriel	Isuzu	Gabriel	Isuzu	Gabriel
60670005L	83137	8-98098-058-1	83159	8970830270	83515	8983810120	83515
8-22064-233-0	83136	8-98098-059-0	83159	8970830290	83515	9-51630-647-1	83515
8-22064-804-0	83136	8-98098-059-1	83159	8972019600	83515	9-51630-666-0	85012
8-22064-805-0	83136	8-98098-125-0	83515	8972536160	83515	9-51630-666-0	89413
8-22064-806-0	83136	8-98098-127-0	83515	8972536200	83515	9-51630-666-2	85012
8-22064-807-0	83136	8-98232671-0	83515	8972536201	83515	9-51630-666-2	89413
8-22064232-0	85071	8-98232671-1	83515	8972536210	83515	94454986	83515
8-22064233-0	83136	8-98232672-0	83515	8972536230	83515	94454987	83515
8-22064804-0	83136	8-98232672-1	83515	8975179660	83137	9516306660	85012
8-22064805-0	83136	8-98316-228-0	83159	8975179661	83137	9516306660	89413
8-94454-647-1	83515	8-98316227-0	83159	898098-0581	83159	9516306662	85012
8-94454-986-0	83515	8-98321-912-1	85071	898098-1250	83515	9516306662	89413
8-94454-987-0	83515	8-98343986-0	83159	898098-1270	83515	97083027	83515
8-97083-027-0	83515	8-98380-746-0	83159	8980980590	83159	97083029	83515
8-97083-029-0	83515	8-98380-747-0	83159	8980980591	83159	97253620	83515
8-97253-616-0	83515	8-98381-010-0	83515	8980981250	83515	97253651	83159
8-97253-620-0	83515	8-98381-012-0	83515	8980981270	83515	97253664	83159
8-97253-620-1	83515	8220642320	85071	8982326710	83515	97253665	83159
8-97253-621-0	83515	8220642330	83136	8982326711	83515	98098058	83159
8-97253-623-0	83515	8220648040	83136	8982326720	83515	98098059	83159
8-97253-651-2	83159	8220648050	83136	8982326721	83515	98098125	83515
8-97253-664-0	83159	8220648060	83136	8983162280	83159	98098127	83515
8-97253-665-0	83159	8220648070	83136	8983219121	85071	98232671	83515
8-97517-966-0	83137	88982682	83136	8983807460	83159	98232672	83515
8-97517-966-1	83137	88982686	85071	8983807470	83159	98316227	83159
8-98098-058-0	83159	8944549870	83515	8983810100	83515	98343986	83159

Itasca

Itasca	Gabriel	Itasca	Gabriel	Itasca	Gabriel	Itasca	Gabriel
141700131809	85029	8C24-18080-DB	G63623	ASH-1228	83209	ASH25824	89406
141700131810	83160	8C2Z-18124-D	G63622	ASH-1228	89414	AT-163G	G63622
16-16736-000	85029	8C2Z-18125-D	G63623	ASH-1229	83209	AT-164G	G63623
16-16737-000	83160	9U94-18045-AA	83209	ASH-1229	89414	AT-620	83209
16-16873-000	85029	9U94-18045-AA	89414	ASH-1230	83122	AT-620	89414
16-16874-000	83160	9U94-18080-AA	83122	ASH-1230	89406	AT-621	83122
16-18103-000	85900	9U94-18080-AA	89406	ASH-137	83122	AT-621	89406
1616736000	85029	9U9418080AA	83122	ASH-137	89406	AT-766	83209
1616737000	83160	9U9418080AA	89406	ASH-25822	83209	AT-766	89414
1616873000	85029	9U9Z-18124-A	83209	ASH-25822	89414	AT621	83122
1616874000	83160	9U9Z-18124-A	89414	ASH-25823	83209	AT621	89406
1618103000	85900	9U9Z-18125-A	83122	ASH-25823	89414	F4-BE5-A832-MO	85125
1C34-18045-AA	83209	9U9Z-18125-A	89406	ASH-25824	83122	F4-BE5-B492-HO	85125
1C34-18045-AA	89414	9U9Z18125A	83122	ASH-25824	89406	F4-BE5-F324-HO	85125
1C34-18045-JA	83209	9U9Z18125A	89406	ASH-294	83209	F4-BE5-F325-HO	85124
1C34-18045-JA	89414	ASH-1022	83209	ASH-294	89414	F4BE5A832MO	85125
24-153249	85125	ASH-1022	89414	ASH1023	83122	F4BE5B492HO	85125
24-153256	85124	ASH-1023	83122	ASH1023	89406	F4BE5F324HO	85125
24-186629	85125	ASH-1023	89406	ASH1206	83122	F4BE5F325HO	85124
24153249	85125	ASH-1136	G63623	ASH1206	89406	W0005662	85125
24153256	85124	ASH-1154	G63622	ASH1230	83122	W0005663	85124
24186629	85125	ASH-1205	83209	ASH1230	89406	W0006254	85125
481700000490	85900	ASH-1205	89414	ASH137	83122		
481700000493	85900	ASH-1206	83122	ASH137	89406		
8C24-18045-DA	G63622	ASH-1206	89406	ASH25824	83122		

Jayco RV Inc

Jayco RV Inc	Gabriel	Jayco RV Inc	Gabriel	Jayco RV Inc	Gabriel	Jayco RV Inc	Gabriel
10-13976-000	85918	1013976000	85918				
10-13976-000	89449	1013976000	89449				

Important Note: Competitive Interchanges are to be used for stocking purposes only. Where multiple crosses are identified, please reference the applications section of this catalog. / **Remarque importante:** Les interchanges concurrentiels ne s'utilisent qu'aux fins de stocks. Dans le cas de références multiples, consulter la section des applications du catalogue. / **Nota importante:** Dans le cas de références multiples, consulter la section des applications du catalogue. / **Nota importante:** Se pueden usar intercambios competitivos para propósitos de almacenamiento solamente. Cuando se identifican intercambios múltiples, consulte la sección de aplicaciones de este catálogo.

COMPETITIVE & O.E.M. INTERCHANGE LIST
Lista de Intercambios contra Competidores y Equipo Original.
Liste d'interchange de produits compétitifs & déquippement original (OEM)

Jayco RV Inc... cont'd

Jayco RV Inc	Gabriel	Jayco RV Inc	Gabriel	Jayco RV Inc	Gabriel	Jayco RV Inc	Gabriel
16-16764-000	85724	ASH-1136	G63623	ASH-25822	83209	ASH-25824	83122
16-16764-000	89443	ASH-1154	G63622	ASH-25822	89414	ASH-25824	89406
1616764000	85724	ASH-1229	83209	ASH-25823	83209	ASH25824	83122
1616764000	89443	ASH-1229	89414	ASH-25823	89414	ASH25824	89406

John Deere

John Deere	Gabriel	John Deere	Gabriel	John Deere	Gabriel	John Deere	Gabriel
3638112	G63183						

Kenworth

Kenworth	Gabriel	Kenworth	Gabriel	Kenworth	Gabriel	Kenworth	Gabriel
02-02738-2	85012	12011044	83025	60670-008PLUS-2	83123	665931	83312
02-02738-2	89413	1202-0042	83025	60670-008PLUS-2	89405	665931	89409
02-02738PLUS	85012	1202-0043	83025	60670004	83123	665932	85012
02-02738PLUS	89413	1202-0044	83025	60670004	89405	665932	89413
02-02738PLUS-2	85012	1202-0054	83021	60670005	83137	665944	85900
02-02738PLUS-2	89413	1202-1043	83025	60670005L	83137	665944-2	85900
02-02739-2	85013	12020042	83025	60670005PLUS	83137	665945	85902
02-02739-2	89414	12020043	83025	60670008	83123	665945-2	85902
02-02739PLUS	85013	12020044	83025	60670008	89405	665950	85902
02-02739PLUS	89414	12020054	83021	60670008L	83123	680241	85311
02-02740-2	89405	12021043	83025	60670008L	89405	680241	89424
02-02741-2	85012	16725-01	83126	60670008PLUS	83123	680253	89425
02-02741-2	89413	16725-01	89430	60670008PLUS	89405	680279	83209
02-04010-2	85012	1672501	83126	60670008PLUS2	83123	680279	89414
02-04010-2	89413	1672501	89430	60670008PLUS2	89405	680475	89425
02-0739PLUS-2	85013	1707378PAC	85182	60675-017	85979	680586	85311
02-0739PLUS-2	89414	19495-01	83126	60675017	85979	680586	89424
0202738PLUS	85012	19495-01	89430	60680-004	83143	70701	85900
0202738PLUS	89413	1949501	83126	60680-004L	83143	70701PLUS	85900
0202738PLUS2	85012	1949501	89430	60680-005	83142	70701PLUS-2	85900
0202738PLUS2	89413	2027382	85012	60680-005L	83142	90044025PLUS	83209
02027392	85013	2027382	89413	60680004	83143	90044025PLUS	89414
02027392	89414	47902-13PLUS	83122	60680004L	83143	ACHB966	83136
0202739PLUS	85013	47902-13PLUS	89406	60680005	83142	B71-1000	85031
0202739PLUS	89414	47902-19	83123	60680005L	83142	B71-1003	83312
02027402	89405	47902-19	89405	64178-001	83143	B71-1003	89409
02027412	85012	47902-24	83137	64178001	83143	B71-6002	85012
02027412	89413	4790213PLUS	83122	665092	83312	B71-6002	89413
02040102	85012	4790213PLUS	89406	665092	89409	B71-6002-2	85012
02040102	89413	4790219	83123	665118	83312	B71-6002-2	89413
020739PLUS2	85013	4790219	89405	665118	89409	B71-6003	85029
020739PLUS2	89414	4790224	83137	665617	85031	B71-6003-2	85029
03-06084PLUS-2	85031	60657-003	85072	665617-2	85031	B71-6004	85084
03-07421PLUS	85311	60657-003L	85072	6656172	85031	B71-6004	89460
03-07421PLUS	89424	60657003	85072	665632	85013	B71-6005	85084
03-08781	85069	60657003L	85072	665632	89414	B71-6005	89460
03-08781	89455	60670-004	83123	665680	83312	B71-6006	85084
03-08781-2	85069	60670-004	89405	665680	89409	B71-6006	89460
03-08781-2	89455	60670-005	83137	665783	83123	B71-6008	83312
0307421PLUS	85311	60670-005L	83137	665783	89405	B71-6008	89409
0307421PLUS	89424	60670-005PLUS	83137	665784	83122	B71-6013	85012
0308781	85069	60670-005PLUS-2	83137	665784	89406	B71-6013	89413
0308781	89455	60670-008	83123	665785	83137	B71-6015	85012
03087812	85069	60670-008	89405	665844	85069	B71-6015	89413
03087812	89455	60670-008L	83123	665844	89455		
1201-1043	83025	60670-008L	89405	665903	85900		
1201-1044	83025	60670-008PLUS	83123	665906	85902		
12011043	83025	60670-008PLUS	89405	665918	85900		

Important Note: Competitive Interchanges are to be used for stocking purposes only. Where multiple crosses are identified, please reference the applications section of this catalog. / **Remarque importante:** Les interchanges concurrentiels ne s'utilisent qu'aux fins de stocks. Dans le cas de références multiples, consulter la section des applications du catalogue. / **Nota importante:** Dans le cas de références multiples, consulter la section des applications du catalogue. / **Nota importante:** Se pueden usar intercambios competitivos para propósitos de almacenamiento solamente. Cuando se identifican intercambios múltiples, consulte la sección de aplicaciones de este catálogo.

COMPETITIVE & O.E.M. INTERCHANGE LIST
Lista de Intercambios contra Competidores y Equipo Original.
Liste d'interchange de produits compétitifs & déquippement original (OEM)

Kenworth... cont'd

Kenworth	Gabriel	Kenworth	Gabriel	Kenworth	Gabriel	Kenworth	Gabriel
B71-6016	85012	B716018	85012	C711017	85069	K374-5	89409
B71-6016	89413	B716018	89413	C711017	89455	K374-C31	83312
B71-6018	85012	B716019	85989	C716003	85988	K374-C31	89409
B71-6018	89413	B716020	85989	C716005	85069	K37410	83215
B71-6019	85989	BFRG 072	85182	C716005	89455	K374102	83215
B71-6020	85989	C71-1011	85069	K374-10	83215	K37414	83312
B711000	85031	C71-1011	89455	K374-10-2	83215	K37414	89409
B711003	83312	C71-1011PLUS	85069	K374-14	83312	K37428	89425
B711003	89409	C71-1011PLUS	89455	K374-14	89409	K374282	89425
B716002	85012	C71-1011PLUS-2	85069	K374-28	89425	K37428PLUS	89425
B716002	89413	C71-1011PLUS-2	89455	K374-28-2	89425	K3743	83312
B716003	85029	C71-1011SPL	85069	K374-28PLUS	89425	K3743	89409
B716004	85084	C71-1011SPL	89455	K374-3	83312	K37431	83312
B716004	89460	C71-1017	85069	K374-3	89409	K37431	89409
B716005	85084	C71-1017	89455	K374-3-1	83312	K37433	83312
B716005	89460	C71-6003	85988	K374-3-1	89409	K37433	89409
B716006	85084	C71-6005	85069	K374-33	83312	K37433PLUS	83312
B716006	89460	C71-6005	89455	K374-33	89409	K37433PLUS	89409
B716008	83312	C711011	85069	K374-33-2	83312	K3744	89425
B716008	89409	C711011	89455	K374-33-2	89409	K3745	83312
B716013	85012	C711011PLUS	85069	K374-33PLUS	83312	K3745	89409
B716013	89413	C711011PLUS	89455	K374-33PLUS	89409	K374C31	83312
B716015	85012	C711011PLUS2	85069	K374-33PLUS-2	83312	K374C31	89409
B716015	89413	C711011PLUS2	89455	K374-33PLUS-2	89409	TK19679	83126
B716016	85012	C711011SPL	85069	K374-4	89425	TK19679	89430
B716016	89413	C711011SPL	89455	K374-5	83312		

King Of The Road

King Of The Road	Gabriel	King Of The Road	Gabriel	King Of The Road	Gabriel	King Of The Road	Gabriel
141700131809	85029	16-16873-000	85029	1616737000	83160	481700000490	85900
141700131810	83160	16-16874-000	83160	1616873000	85029	481700000493	85900
16-16736-000	85029	16-18103-000	85900	1616874000	83160		
16-16737-000	83160	1616736000	85029	1618103000	85900		

Koni

Koni	Gabriel	Koni	Gabriel	Koni	Gabriel	Koni	Gabriel
30-1366	G63610	88-1457-SP1	83209	88-1641SP3	85029	8805-1022	89443
82-1952	G63347	88-1457-SP1	89414	88-1646	83613	8805-1023	83136
82-1954	G63355	88-1458-SP1	83122	88-1647	83317	8805-1042	G63622
82-1955	G63349	88-1458-SP1	89406	88-5162	83209	8805-1043	G63623
82-1970	G63350	88-1458-SP2	83122	88-5162	89414	8850-1002	G63622
82-2158	G63357	88-1458-SP2	89406	88-5163	83122	90-1898	83215
82-2246	G63299	88-1468	83209	88-5163	89406	90-1922	85900
82-2345	G63413	88-1468	89414	8805-1001	85125	90-1974	85311
82-2372	G63609	88-1489	89405	8805-1002	85124	90-1974	89424
82-2384	G63488	88-1558	85013	8805-1018	83209	90-2257	85716
8240-1029	G63386	88-1558	89414	8805-1018	89414	90-2477	85900
8240-1054	G63375	88-1559-SP1	89405	8805-1019	83122	90-2478	85902
88-1417	83312	88-1561	85012	8805-1019	89406	90-2563	85006
88-1417	89409	88-1561	89413	8805-1020	83160	99B-3254	85029
88-1419	83136	88-1641	85029	8805-1022	85724		

Krystal Bus

Krystal Bus	Gabriel	Krystal Bus	Gabriel	Krystal Bus	Gabriel	Krystal Bus	Gabriel
ASH-1136	G63623	ASH-1154	G63622	ASH1136	G63623	ASH1154	G63622

KYB

KYB	Gabriel	KYB	Gabriel	KYB	Gabriel	KYB	Gabriel
335809	G56778	340084	83515	341343	G63783	341615	83215
335810	G56778	341339	G63918	341343	G63893	341617	85005

Important Note: Competitive Interchanges are to be used for stocking purposes only. Where multiple crosses are identified, please reference the applications section of this catalog. / **Remarque importante:** Les interchanges concurrentiels ne s'utilisent qu'aux fins de stocks. Dans le cas de références multiples, consulter la section des applications du catalogue. / **Nota importante:** Dans le cas de références multiples, consulter la section des applications du catalogue. / **Nota importante:** Se pueden usar intercambios competitivos para propósitos de almacenamiento solamente. Cuando se identifican intercambios múltiples, consulte la sección de aplicaciones de este catálogo.

COMPETITIVE & O.E.M. INTERCHANGE LIST
Lista de Intercambios contra Competidores y Equipo Original.
Liste d'interchange de produits compétitifs & déquippement original (OEM)

KYB... cont'd

KYB	Gabriel	KYB	Gabriel	KYB	Gabriel	KYB	Gabriel
341617	89430	344372	G63661	349183	G63886	554233	77783
341618	85918	344373	G63674	349191	G63894	554236	77614
341618	89449	344373	G63675	349225	G64042	554238	77614
341619	83136	344376	G63673	441133	83515	554239	77607
341621	85311	344378	G63403	441602	85724	554240	77808
341621	89424	344379	G63403	441602	89443	554241	77808
341624	89405	344380	G63783	444012	G63492	554246	77783
341627	85006	344382	G63808	444024	G63492	554247	77817
341628	85724	344383	G63817	444058	83159	554249	77412
341628	89443	344386	G63675	444203	83515	554257	77907
341633	83215	344387	G63692	444209	83114	554260	77414
343147	81340	344400	G64009	444244	G63409	554270	77412
343149	82155	344402	G63783	444249	G63489	554274	77614
343219	81270	344409	G63918	444250	G63488	554277	G63623
343425	G63409	344413	G63810	444252	G63638	554312	77375
343484	G64089	344419	G63888	444254	G63366	554319	77817
3440029	77967	344426	G63299	444256	G63455	554322	77949
3440067	G64177	344481	G63894	444269	83159	554324	77638
344044	G63492	344483	G63896	444328	83159	554342	G63894
344045	G63492	3450011	G64043	445016	83515	554344	77638
344055	G63299	3450014	G64121	445054	83613	554347	77951
344066	G63359	345025	83515	445064	83162	554347	77967
344067	G63347	345030	G63394	445067	85009	554348	77638
344068	G63355	345061	77949	446075	83215	554356	G63895
344070	G63353	345062	G63971	5530004	G64089	554359	77949
344071	G63350	345070	G63888	553153	77907	554360	77950
344072	G63349	345072	G64010	553256	83159	554362	77968
344073	G63413	345080	G63622	5540000	77951	554362	77969
344074	G63183	345601	83613	5540005	G63918	554369	77807
344075	G63413	345605	85012	5540007	G64089	554370	77623
344076	G63410	345605	89413	5540017	G64089	554374	G64043
344078	G63409	345606	83136	5540022	77976	554375	G64043
344081	G63375	345609	83515	554003	G63610	554379	G64042
344085	G63306	345611	83120	554060	G63455	554380	83159
344086	G63353	345613	85005	554075	77907	554382	G64089
344087	G63377	345613	89430	554101	77907	554383	83159
344090	G63492	345614	83309	554153	77489	554388	77952
344262	G63638	345615	83314	554154	77638	554389	G64121
344262	G63897	345618	83126	554161	77375	554390	G64043
344263	G63488	345618	89430	554163	77609	5550006	77976
344263	G63638	345620	83456	554168	77461	555038	77614
344264	G63387	345620	89447	554173	77907	555039	77623
344265	G63489	345624	G64148	554174	G63299	555055	77976
344265	G63783	349001	G63918	554177	77614	555056	77952
344266	G63609	349004	58944	554178	77608	565033	77638
344267	G63455	349009	G63897	554199	77950	565060	77375
344268	G63614	349044	G64089	554203	G63386	565062	77609
344272	G63386	349045	G64089	554206	77638	565068	77412
344273	G63638	349046	G63895	554207	77661	565090	77809
344304	G63375	349073	G64042	554208	77661	565091	77809
344328	83159	349110	G64043	554209	77662	565101	77783
344364	77980	349117	G64042	554210	G63353	KG4026	G63492
344365	G63662	349119	83159	554211	G63350	KG4503	82026
344366	G63366	349127	83159	554216	77662	KG5196	77950
344370	G63622	349146	G63888	554223	77662	KG5401	G63299
344371	G63623	349147	G64121	554228	77661	KG5404	G63360

Important Note: Competitive Interchanges are to be used for stocking purposes only. Where multiple crosses are identified, please reference the applications section of this catalog. / **Remarque importante:** Les interchanges concurrentiels ne s'utilisent qu'aux fins de stocks. Dans le cas de références multiples, consulter la section des applications du catalogue. / **Nota importante:** Dans le cas de références multiples, consulter la section des applications du catalogue. / **Nota importante:** Se pueden usar intercambios competitivos para propósitos de almacenamiento solamente. Cuando se identifican intercambios múltiples, consulte la sección de aplicaciones de este catálogo.

COMPETITIVE & O.E.M. INTERCHANGE LIST
Lista de Intercambios contra Competidores y Equipo Original.
Liste d'interchange de produits compétitifs & déquippement original (OEM)

KYB... cont'd

KYB	Gabriel	KYB	Gabriel	KYB	Gabriel	KYB	Gabriel
KG5406	G63386	KG54332	77808	KG5495	77608	KG6412	G63625
KG54100	77638	KG54333	77810	KG5497	77807	KG6413	77614
KG54101	77638	KG54333	G63810	KG5497	G63622	KG6413	G63622
KG54102	77661	KG54339	77783	KG5498	77623	KG6414	77623
KG54103	77674	KG54340	77817	KG5498	G63623	KG6415	85013
KG54103	77948	KG54341	77662	KG5534	G63610	KG6415	89414
KG54103	77980	KG54342	77412	KG5572	77375	KG6416	83123
KG54104	77662	KG5438	77907	KG5780	G63894	KG6416	89405
KG5420	G63366	KG5440	77414	KG5786	77949	SR4175	G57206
KG5421	G63387	KG5440	G63350	KG6003	83309	SR4176	G57206
KG5422	G63183	KG5455	G63456	KG6005	83216	SR4195	G57206
KG54306	77675	KG5458	77375	KG6006	85012	SR4196	G57206
KG54315	77673	KG5466	G63492	KG6006	89413	SS10202	14072
KG54320	77455	KG5478	77489	KG6008A	83122	SS10309	6854SE
KG54321	77403	KG5479	77488	KG6008A	89406	SS10318	6853SE
KG54322	77403	KG5480	77609	KG6010	83308	SS10322	6856SE
KG54326	77783	KG5481	G63411	KG6199	85012	SS10323	6847SE
KG54329	77607	KG5482	77412	KG6199	89413	SS10325	14017
KG54330	77809	KG5488	G63403	KG6201	83456	SS10325	6804SE
KG54330	G63809	KG5489	77614	KG6201	89447	SS15345	6802SE
KG54331	77837	KG5489	G63614	KG6406	G63183	SS15489	6855SE
KG54331	G63837	KG5493	77461	KG6407	G63394		

Leacree

Leacree	Gabriel	Leacree	Gabriel	Leacree	Gabriel	Leacree	Gabriel
30372439	G63610	309112659	G64010	309112679	G63888		

Les Schwab

Les Schwab	Gabriel	Les Schwab	Gabriel	Les Schwab	Gabriel	Les Schwab	Gabriel
14017	14017	49310	49310	61543	61543	6803SE	6803SE
14072	14072	49311	49311	61544	61544	6804SE	6804SE
34036	34036	58357	58357	61546	61546	6828SE	6828SE
34052	34052	58359	58359	61547	61547	6847SE	6847SE
34058	34058	58403	58403	61554	61554	6850SE	6850SE
34073	34073	58412	58412	61555	61555	6853SE	6853SE
34076	34076	58488	58488	61591	61591	6854SE	6854SE
43048	43048	58489	58489	61592	61592	6855SE	6855SE
43058	43058	58609	58609	61599	61599	6856SE	6856SE
43085	43085	58622	58622	61614	61614	71500	61500
43099	43099	58623	58623	61632	61632	71506	61506
43111	43111	58638	58638	61634	61634	71520	61520
43140	43140	58662	58662	61635	61635	71522	61522
43163	43163	58807	58807	61642	61642	71542	61542
43167	43167	58808	58808	61646	61646	71565	61565
43180	43180	58809	58809	61654	61654	71600	61600
43181	43181	58810	58810	61655	61655	71641	61641
49107	49107	58817	58817	61656	61656	77375	77375
49127	49127	58929	58929	61663	61663	77403	77403
49149	49149	58930	58930	61680	61680	77412	77412
49155	49155	58944	58944	61682	61682	77414	77414
49162	49162	61516	61516	61683	61683	77455	77455
49173	49173	61517	61517	61684	61684	77461	77461
49178	49178	61518	61518	61685	61685	77488	77488
49203	49203	61519	61519	61687	61687	77489	77489
49205	49205	61521	61521	61710	61710	77607	77607
49212	49212	61523	61523	61713	61713		
49218	49218	61524	61524	61714	61714		
49231	49231	61525	61525	61716	61716		
49235	49235	61530	61530	6802SE	6802SE		

Important Note: Competitive Interchanges are to be used for stocking purposes only. Where multiple crosses are identified, please reference the applications section of this catalog. / **Remarque importante:** Les interchanges concurrentiels ne s'utilisent qu'aux fins de stocks. Dans le cas de références multiples, consulter la section des applications du catalogue. / **Nota importante:** Dans le cas de références multiples, consulter la section des applications du catalogue. / **Nota importante:** Se pueden usar intercambios competitivos para propósitos de almacenamiento solamente. Cuando se identifican intercambios múltiples, consulte la sección de aplicaciones de este catálogo.

COMPETITIVE & O.E.M. INTERCHANGE LIST
Lista de Intercambios contra Competidores y Equipo Original.
Liste d'interchange de produits compétitifs & équipement original (OEM)

Les Schwab... cont'd

Les Schwab	Gabriel	Les Schwab	Gabriel	Les Schwab	Gabriel	Les Schwab	Gabriel
77608	77608	81484	81484	G60410	G63349	G63661	G63661
77609	77609	81490	81490	G60414	G63355	G63671	G63671
77614	77614	81496	81496	G60415	G63357	G63692	G63692
77623	77623	81510	81510	G60417	G63359	G63808	G63808
77638	77638	81667	81667	G60423	G63386	G63837	G63837
77661	77661	81668	81668	G60424	G63387	G63893	G63893
77662	77662	81676	81676	G60428	G63183	G63894	G63894
77673	77673	81710	81710	G60433	G63410	G63895	G63895
77674	77674	81713	81713	G60435	G63409	G63896	G63896
77675	77675	81726	81726	G60439	G63413	G63897	G63897
77783	77783	81744	81744	G60476	G63375	G63918	G63918
77807	77807	81821	81821	G60480	G63455	G63969	G63969
77808	77808	81825	81825	G60484	G63461	G63971	G63971
77809	77809	81828	81828	G60497	G63488	G64009	G64009
77810	77810	81834	81834	G60498	G63489	G64010	G64010
77817	77817	81873	81873	G60511	G63403	G64042	G64042
77837	77837	81919	81919	G60561	G63607	G64043	G64043
77907	77907	81920	81920	G60571	G63614	G64089	G64089
77948	77948	81921	81921	G60582	G63622	G64121	G64121
77949	77949	81925	81925	G60583	G63623	G64148	G64148
77950	77950	81928	81928	G60606	G63662	G64164	G64164
77951	77951	82003	82003	G60616	G63673	G64168	G64168
77952	77952	82007	82007	G60617	G63674	G64177	G64177
77967	77967	82012	82012	G60618	G63675	G64246	G64246
77968	77968	82026	82026	G61524	G63783	G64268	G64268
77969	77969	82035	82035	G61550	G63809	G64269	G64269
77976	77976	82047	82047	G61551	G63810	NM1001	NM1001
77980	77980	82065	82065	G61558	G63817	NM1004	NM1004
77986	77986	82066	82066	G61886	G63886	NM1005	NM1005
77987	77987	82086	82086	G61888	G63888	NM1007	NM1007
77988	77988	82155	82155	G62011	G64011	NM1008	NM1008
81039	81039	G56778	G56778	G62013	G64013	NM1009	NM1009
81082	81082	G57206	G57206	G63299	G63299	NM1010	NM1010
81091	81091	G57800	G57800	G63306	G63306	NM1014	NM1014
81096	81096	G57801	G57801	G63350	G63350	NM1015	NM1015
81113	81113	G57802	G57802	G63353	G63353	NM1016	NM1016
81147	81147	G57816	G57816	G63360	G63360	NM1019	NM1019
81164	81164	G57852	G57852	G63366	G63366	NM1020	NM1020
81242	81242	G57853	G57853	G63394	G63394	NM1024	NM1024
81270	81270	G60031	G63405	G63411	G63411	NM1025	NM1025
81318	81318	G60042	G63377	G63456	G63456	NM1028	NM1028
81340	81340	G60101	G63492	G63609	G63609	NM1029	NM1029
81342	81342	G60164	G63610	G63625	G63625		
81394	81394	G60408	G63347	G63638	G63638		

Leyland Truck

Leyland Truck	Gabriel	Leyland Truck	Gabriel	Leyland Truck	Gabriel	Leyland Truck	Gabriel
1456033	85311	1456033	89424				

LGE Coachworks

LGE Coachworks	Gabriel	LGE Coachworks	Gabriel	LGE Coachworks	Gabriel	LGE Coachworks	Gabriel
ASH-1136	G63623	ASH-1154	G63622				

Link Manufacturing LTD

Link Manufacturing LTD	Gabriel	Link Manufacturing LTD	Gabriel	Link Manufacturing LTD	Gabriel	Link Manufacturing LTD	Gabriel
1201-1043	83025	1201-9009	83054	12019008	83054	1202-0052	83021
1201-1044	83025	12011043	83025	12019009	83054		
1201-1049	83025	12011044	83025	1202-0042	83025		
1201-9007	83054	12011049	83025	1202-0043	83025		
1201-9008	83054	12019007	83054	1202-0044	83025		

Important Note: Competitive Interchanges are to be used for stocking purposes only. Where multiple crosses are identified, please reference the applications section of this catalog. / **Remarque importante:** Les interchanges concurrentiels ne s'utilisent qu'aux fins de stocks. Dans le cas de références multiples, consulter la section des applications du catalogue. / **Nota importante:** Dans le cas de références multiples, consulter la section des applications du catalogue. / **Nota importante:** Se pueden usar intercambios competitivos para propósitos de almacenamiento solamente. Cuando se identifican intercambios múltiples, consulte la sección de aplicaciones de este catálogo.

COMPETITIVE & O.E.M. INTERCHANGE LIST
Lista de Intercambios contra Competidores y Equipo Original.
Liste d'interchange de produits compétitifs & déquippement original (OEM)

Link Manufacturing LTD... cont'd

Link Manufacturing LTD	Gabriel	Link Manufacturing LTD	Gabriel	Link Manufacturing LTD	Gabriel	Link Manufacturing LTD	Gabriel
1202-0054	83021	12020043	83025	12021043	83025	654799	83025
1202-1042	83025	12020044	83025	12021044	83025	654833	83021
1202-1043	83025	12020052	83021	1210-0528	85043	654867	83025
1202-1044	83025	12020054	83021	12100528	85043	671093	85043
12020042	83025	12021042	83025	654669	83021		

Lion Bus

Lion Bus	Gabriel	Lion Bus	Gabriel	Lion Bus	Gabriel	Lion Bus	Gabriel
60665-025	89405	60665025L	89405	60670-030	83166	60670018L	83166
60665-025L	89405	60670-018	83166	60670-030L	83166	60670030	83166
60665025	89405	60670-018L	83166	60670018	83166	60670030L	83166

Lodal Inc

Lodal Inc	Gabriel	Lodal Inc	Gabriel	Lodal Inc	Gabriel	Lodal Inc	Gabriel
9960257	83122	9960257	89406				

Mack

Mack	Gabriel	Mack	Gabriel	Mack	Gabriel	Mack	Gabriel
14QK-140P1	83225	14QK-392AM3	85005	14QK366P1	89405	21345868	83066
14QK-142AP1	83215	14QK-392AM3	89430	14QK366P2	89405	21345869	83066
14QK-142P1	83215	14QK-392BM	85005	14QK366P3	89405	21436094	85927
14QK-2100	83221	14QK-392BM	89430	14QK366P4	83209	21490486	83066
14QK-2100P1	83221	14QK-392BM3	85005	14QK366P4	89414	22314111	89405
14QK-2100P2	83209	14QK-392BM3	89430	14QK372M	83221	23145372	83066
14QK-2100P2	89414	14QK-392M	85005	14QK372M2	83209	23159760	85188
14QK-2100P5	83221	14QK-392M	89430	14QK372M2	89414	23159762	85188
14QK-2100P6	89405	14QK-393AM	83123	14QK372M3	83122	23359394	83101
14QK-2100P7	83221	14QK-393AM	89405	14QK372M3	89406	23818296	85978
14QK-2105	83209	14QK-393M	85010	14QK373	83215	24145343	85005
14QK-2105	89414	14QK-396	85005	14QK375M	83123	24145343	89430
14QK-2107	83209	14QK-396	89430	14QK375M	89405	25621571	83215
14QK-2107	83215	14QK-396M	85005	14QK377M	83215	25623321	83215
14QK-2107	89414	14QK-396M	89430	14QK378	83215	25625091	83215
14QK-2107P1	83215	14QK-410M2	83137	14QK378M	83215	25625151	89405
14QK-2107P2	83215	14QK-423M	85978	14QK392AM	85005	25625187	83209
14QK-2107P3	83215	14QK-429M2	85072	14QK392AM	89430	25625187	89414
14QK-282P1	83216	14QK-493M	83101	14QK392AM2	85005	25625743	85005
14QK-282P3	83216	14QK-5142	83142	14QK392AM2	89430	25625743	89430
14QK-3116M	83101	14QK140P1	83225	14QK392AM3	85005	25626196	83142
14QK-366	89405	14QK142AP1	83215	14QK392AM3	89430	25632561	83209
14QK-366P1	89405	14QK142P1	83215	14QK392BM	85005	25632561	89414
14QK-366P2	89405	14QK2100	83221	14QK392BM	89430	471700015341	83127
14QK-366P3	89405	14QK2100P1	83221	14QK392BM3	85005	47902-9	83123
14QK-366P4	83209	14QK2100P2	83209	14QK392BM3	89430	47902-9	89405
14QK-366P4	89414	14QK2100P2	89414	14QK392M	85005	479029	83123
14QK-372M	83221	14QK2100P5	83221	14QK392M	89430	479029	89405
14QK-372M2	83209	14QK2100P6	89405	14QK393AM	83123	4940654	83216
14QK-372M2	89414	14QK2100P7	83221	14QK393AM	89405	5966-90044025	83209
14QK-372M3	83122	14QK2105	83209	14QK393M	85010	5966-90044025	89414
14QK-372M3	89406	14QK2105	89414	14QK396	85005	596690044025	83209
14QK-373	83215	14QK2107	83209	14QK396	89430	596690044025	89414
14QK-375M	83123	14QK2107	83215	14QK396M	85005	60657-007	85072
14QK-375M	89405	14QK2107	89414	14QK396M	89430	60657007	85072
14QK-377M	83215	14QK2107P1	83215	14QK410M2	83137	60675-001	85978
14QK-378	83215	14QK2107P2	83215	14QK423M	85978	60675-001L	85978
14QK-378M	83215	14QK2107P3	83215	14QK493M	83101	60675-13	89405
14QK-392AM	85005	14QK282P1	83216	14QK5142	83142		
14QK-392AM	89430	14QK282P3	83216	20782199	85072		
14QK-392AM2	85005	14QK3116M	83101	21010744	83101		
14QK-392AM2	89430	14QK366	89405	21155033	83101		

Important Note: Competitive Interchanges are to be used for stocking purposes only. Where multiple crosses are identified, please reference the applications section of this catalog. / **Remarque importante:** Les interchanges concurrentiels ne s'utilisent qu'aux fins de stocks. Dans le cas de références multiples, consulter la section des applications du catalogue. / **Nota importante:** Dans le cas de références multiples, consulter la section des applications du catalogue. / **Nota importante:** Se pueden usar intercambios competitivos para propósitos de almacenamiento solamente. Cuando se identifican intercambios múltiples, consulte la sección de aplicaciones de este catálogo.

COMPETITIVE & O.E.M. INTERCHANGE LIST
Lista de Intercambios contra Competidores y Equipo Original.
Liste d'interchange de produits compétitifs & équipement original (OEM)

Mack... cont'd

Mack	Gabriel	Mack	Gabriel	Mack	Gabriel	Mack	Gabriel
60675001	85978	60680-005L	83142	650402	89424	651151	89414
60675001L	85978	60680004	83143	650402MT	85311	78530771	83127
6067513	89405	60680004L	83143	650402MT	89424	8083872	85978
60680-004	83143	60680005	83142	651012	83221	H60680004	83143
60680-004L	83143	60680005L	83142	651103	89405	H60680005	83142
60680-005	83142	650402	85311	651151	83209		

Maeco

Maeco	Gabriel	Maeco	Gabriel	Maeco	Gabriel	Maeco	Gabriel
12788	83216	16772	89406	16780	89405	70331	89425
16385	83215	16773	85005	16781	85006	70332	83314
16767	85013	16773	89430	16949	83120	70397	85006
16767	89414	16774	83215	6025	83122	70648	89414
16769	83221	16776	83122	6025	89406	70651	85013
16770	83209	16776	89406	70123	85716	70651	89414
16770	89414	16777	85006	70127	85006	70663	85013
16771	83126	16779	83126	70128	85006	70663	89414
16771	89430	16779	89430	70162	85716		
16772	83122	16780	83123	70164	85716		

Mandalay Coach

Mandalay Coach	Gabriel	Mandalay Coach	Gabriel	Mandalay Coach	Gabriel	Mandalay Coach	Gabriel
141700131809	85029	16-16873-000	85029	1616737000	83160	481700000490	85900
141700131810	83160	16-16874-000	83160	1616873000	85029	481700000493	85900
16-16736-000	85029	16-18103-000	85900	1616874000	83160		
16-16737-000	83160	1616736000	85029	1618103000	85900		

Marathon

Marathon	Gabriel	Marathon	Gabriel	Marathon	Gabriel	Marathon	Gabriel
53010-MB	83136	53108-MB	85029	58103-MB	85900	78015-MB	85724
53018-MB	83317	58085-MB	85072	58117-MB	89458	78015-MB	89443
53019-MB	83456	58097-MB	85069	58120-MB	85918	78031-MB	85311
53019-MB	89447	58097-MB	89455	58120-MB	89449	78031-MB	89424
53039-MB	85006	58102-MB	85012	58121-MB	85013		
53106-MB	83127	58102-MB	89413	58121-MB	89414		

Marmon

Marmon	Gabriel	Marmon	Gabriel	Marmon	Gabriel	Marmon	Gabriel
1-7001	83216	37-1-1	83122	51-163-7	83123	576451	83122
1202-0054	83021	37-1-1	89406	51-163-7	89405	576451	89406
12020054	83021	3711	83122	511637	83123	665147	83216
17001	83216	3711	89406	511637	89405		

Mc Neilus Truck and Man

Mc Neilus Truck and Man	Gabriel	Mc Neilus Truck and Man	Gabriel	Mc Neilus Truck and Man	Gabriel	Mc Neilus Truck and Man	Gabriel
060670-018	83166	1429317 MTM	85919	40-5348	89431	6HA961 MTM	83123
1139069 MTM	83209	1485576 MTM	85979	400242	83312	6HA961 MTM	89405
1139069 MTM	89414	1573280	83221	400242	89409	6HB390 MTM	83137
1202-0054	83021	26228-A	83122	405348	85058	6HS773 MTM	83122
12020054	83021	26228-A	89406	405348	89431	6HS773 MTM	89406
1333575 MTM	85072	26228A	83122	4HA569 MTM	85932	7HS237 MTM	83122
1340975 MTM	83142	26228A	89406	4HA569 MTM	89453	7HS237 MTM	89406
1340976 MTM	85919	3638112	G63183	5HA994 MTM	89430	8KK524 MTM	83168
1340979 MTM	83143	3HR582 MTM	85013	60670-018	83166	9HB362 MTM	85976
1398980	83127	3HR582 MTM	89414	60670018	83166	P117099	83120
1398980 MTM	83127	40-0242	83312	651444	83221		
1410046 MTM	85919	40-0242	89409	665060	83122		
1411765 MTM	83148	40-5348	85058	665060	89406		

Mercedes Benz

Mercedes Benz	Gabriel	Mercedes Benz	Gabriel	Mercedes Benz	Gabriel	Mercedes Benz	Gabriel
906 320 04 33	G57802	906 320 10 33	G57802				
906 320 06 33	G57802	906 320 13 33	G57802				

Important Note: Competitive Interchanges are to be used for stocking purposes only. Where multiple crosses are identified, please reference the applications section of this catalog. / **Remarque importante:** Les interchanges concurrentiels ne s'utilisent qu'aux fins de stocks. Dans le cas de références multiples, consulter la section des applications du catalogue. / **Nota importante:** Dans le cas de références multiples, consulter la section des applications du catalogue. / **Nota importante:** Se pueden usar intercambios competitivos para propósitos de almacenamiento solamente. Cuando se identifican intercambios múltiples, consulte la sección de aplicaciones de este catálogo.

COMPETITIVE & O.E.M. INTERCHANGE LIST
Lista de Intercambios contra Competidores y Equipo Original.
Liste d'interchange de produits compétitifs & déquippement original (OEM)

Mercedes Benz... cont'd

Mercedes Benz	Gabriel	Mercedes Benz	Gabriel	Mercedes Benz	Gabriel	Mercedes Benz	Gabriel
907 320 310 0	G64089	907 320 430 1	G64089				

Meritor

Meritor	Gabriel	Meritor	Gabriel	Meritor	Gabriel	Meritor	Gabriel
202447	85919	M83136	83136	M85029	85029	M85902	85902
671907	85919	M83209	83209	M85036	89405	M85918	85918
A-3280-M-9711	85919	M83209	89414	M85043	85043	M85918	89449
A-7805L-1000	85919	M83215	83215	M85058	85058	M85919	85919
A3280M9711	85919	M83456	83456	M85058	89431	M85923	89458
A7805L1000	85919	M83456	89447	M85069	85069	M85927	85927
M83021	83021	M83613	83613	M85069	89455	M85931	89458
M83025	83025	M85005	85005	M85072	85072	M85957	85957
M83122	83122	M85005	89430	M85311	85311	M89413	89413
M83122	89406	M85006	85006	M85311	89424	M89414	89414
M83123	83123	M85012	85012	M85331	85331	M89424	89424
M83123	89405	M85012	89413	M85724	85724	M89430	89430
M83127	83127	M85013	85013	M85724	89443	M89443	89443
M83135	83135	M85013	89414	M85900	85900	M89449	89449

Mitsubishi Fuso

Mitsubishi Fuso	Gabriel	Mitsubishi Fuso	Gabriel	Mitsubishi Fuso	Gabriel	Mitsubishi Fuso	Gabriel
MB161497	G63299	MC114595	G63405	MC813135	83456	MC826268	G63610
MC091947	83162	MC714595	G63405	MC813135	89447	MK302296	G63610
MC091950	83162	MC809390	83103	MC814614	85009	MK433638	G63610

Mohawk

Mohawk	Gabriel	Mohawk	Gabriel	Mohawk	Gabriel	Mohawk	Gabriel
4968853	83216	MM-6957	83225	MM6957	83225		

Monaco Bus

Monaco Bus	Gabriel	Monaco Bus	Gabriel	Monaco Bus	Gabriel	Monaco Bus	Gabriel
01809925	85010	9U9Z-18125-A	89406	ASH-25824	89406	ASH294	89414
1C34-18045-AA	83209	9U9Z18124A	83209	ASH-294	83209	AT-620	83209
1C34-18045-AA	89414	9U9Z18124A	89414	ASH-294	89414	AT-620	89414
1C34-18045-JA	83209	9U9Z18125A	83122	ASH1022	83209	AT-621	83122
1C34-18045-JA	89414	9U9Z18125A	89406	ASH1022	89414	AT-621	89406
1C3418045AA	83209	ASH-1022	83209	ASH1023	83122	AT-766	83209
1C3418045AA	89414	ASH-1022	89414	ASH1023	89406	AT-766	89414
1C3418045JA	83209	ASH-1023	83122	ASH1205	83209	AT620	83209
1C3418045JA	89414	ASH-1023	89406	ASH1205	89414	AT620	89414
24-153249	85125	ASH-1205	83209	ASH1206	83122	AT621	83122
24-153256	85124	ASH-1205	89414	ASH1206	89406	AT621	89406
24-186629	85125	ASH-1206	83122	ASH1228	83209	AT766	83209
24153249	85125	ASH-1206	89406	ASH1228	89414	AT766	89414
24153256	85124	ASH-1228	83209	ASH1229	83209	F4-BE5-A832-MO	85125
24186629	85125	ASH-1228	89414	ASH1229	89414	F4-BE5-B492-HO	85125
9U94-18045-AA	83209	ASH-1229	83209	ASH1230	83122	F4-BE5-F324-HO	85125
9U94-18045-AA	89414	ASH-1229	89414	ASH1230	89406	F4-BE5-F325-HO	85124
9U94-18080-AA	83122	ASH-1230	83122	ASH137	83122	F4BE5A832MO	85125
9U94-18080-AA	89406	ASH-1230	89406	ASH137	89406	F4BE5B492HO	85125
9U9418045AA	83209	ASH-137	83122	ASH25822	83209	F4BE5F324HO	85125
9U9418045AA	89414	ASH-137	89406	ASH25822	89414	F4BE5F325HO	85124
9U9418080AA	83122	ASH-25822	83209	ASH25823	83209	W0005662	85125
9U9418080AA	89406	ASH-25822	89414	ASH25823	89414	W0005663	85124
9U9Z-18124-A	83209	ASH-25823	83209	ASH25824	83122	W0006254	85125
9U9Z-18124-A	89414	ASH-25823	89414	ASH25824	89406		
9U9Z-18125-A	83122	ASH-25824	83122	ASH294	83209		

Monroe

Monroe	Gabriel	Monroe	Gabriel	Monroe	Gabriel	Monroe	Gabriel
12788	83216	16767	85013				
16385	83215	16767	89414				

Important Note: Competitive Interchanges are to be used for stocking purposes only. Where multiple crosses are identified, please reference the applications section of this catalog. / **Remarque importante:** Les interchanges concurrentiels ne s'utilisent qu'aux fins de stocks. Dans le cas de références multiples, consulter la section des applications du catalogue. / **Nota importante:** Dans le cas de références multiples, consulter la section des applications du catalogue. / **Nota importante:** Se pueden usar intercambios competitivos para propósitos de almacenamiento solamente. Cuando se identifican intercambios múltiples, consulte la sección de aplicaciones de este catálogo.

COMPETITIVE & O.E.M. INTERCHANGE LIST
Lista de Intercambios contra Competidores y Equipo Original.
Liste d'interchange de produits compétitifs & équipement original (OEM)

Monroe... cont'd

Monroe	Gabriel	Monroe	Gabriel	Monroe	Gabriel	Monroe	Gabriel
16769	83221	32225	81667	32340	81920	33076	58357
16770	83209	32226	61520	32341	61642	33076	61517
16770	89414	32226	77414	32341	81921	33084	61524
16771	83126	32226	81490	32345	61642	33084	81164
16771	89430	32227	61520	32345	81921	33086	61522
16772	83122	32227	81490	32348	58930	33086	81496
16772	89406	32228	61554	32350	61663	33127	81713
16773	85005	32228	81710	32350	81925	33181	61506
16773	89430	32231	61547	32356	G63614	33190	G64042
16774	83215	32231	81082	32356	G63622	34504	58817
16776	83122	32231	81710	32357	58808	34504	61663
16776	89406	32235	81744	32357	61654	34517	G63837
16777	85006	32239	61530	32358	58809	34518	G63809
16779	83126	32239	81510	32358	61655	34519	G63837
16779	89430	32243	61520	32359	58810	34521	61710
16780	83123	32243	81490	32359	61656	34521	61716
16780	89405	32254	61542	32360	81082	34522	61714
16781	85006	32254	81726	32361	G63394	34523	77967
16949	83120	32259	81744	32362	61685	34523	G63969
171128L	G57206	32262	81270	32362	81668	34524	77968
171128R	G57206	32263	81726	32365	61642	34524	77969
172780L	G57206	32264	58638	32365	81921	34525	61680
172780R	G57206	32264	61565	32366	61635	34526	61682
172985	G57853	32265	61687	32366	81919	34530	61685
172986	G57852	32266	61565	32370	G63692	34534	G64009
181128L	G57206	32266R	61543	32371	61523	34671	61614
181128R	G57206	32267	61591	32371	81096	34672	61614
250322	61614	32267	81744	32372	61547	34675	61641
271128L	G57206	32268	61646	32372	81082	34675MM	61641
271128R	G57206	32268	81828	32373	61542	34676	58662
31000	61500	32277	61599	32373	81726	34676	61600
31000	81147	32277	81928	32375	81342	34676MM	61600
31069	81270	32278	61600	32376	81834	34678	61642
31094	61506	32278	81873	32377	82007	34678	81873
31094	81318	32279	61634	32379	G63411	34684	58807
31094	82012	32279	81919	32380	G63675	34684	G63622
31131	61632	32280	61520	32381	61520	34685	58808
31131	81825	32280	81490	32381	61546	34685	61654
32066	61555	32284	G63387	32385	81091	34685	77808
32066	81713	32285	61521	32386	81510	34685	G63808
32075	61521	32288	61614	32393	G63607	34686	58809
32075	81394	32288	81821	32394	G63809	34686	61655
32080	61518	32293	61500	32395	G63837	34686	G63809
32080	81242	32301	82003	32400	77949	34687	58810
32126	81340	32314	81318	32401	61710	34687	61656
32127	61523	32317	81713	32401	61716	34687	61682
32127	81096	32322	61614	32402	61714	34687	G63810
32127	81834	32323	61614	33033	61525	34689	61641
32128	81091	32326	61641	33033	81039	34689	61663
32164	61519	32326	81920	33049	61592	34690	61642
32164	81484	32327	61600	33049	81340	34690	81921
32207	81676	32327	81873	33049	82066	34692	58930
32207	82007	32327R	81873	33049	82155	34694	58930
32224	61544	32329	81921	33049	G63610	34694	61642
32224	81668	32332	61614	33074	61516	34721	83103
32225	61543	32340	61663	33074	81113	34729	61520

Important Note: Competitive Interchanges are to be used for stocking purposes only. Where multiple crosses are identified, please reference the applications section of this catalog. / **Remarque importante:** Les interchanges concurrentiels ne s'utilisent qu'aux fins de stocks. Dans le cas de références multiples, consulter la section des applications du catalogue. / **Nota importante:** Dans le cas de références multiples, consulter la section des applications du catalogue. / **Nota importante:** Se pueden usar intercambios competitivos para propósitos de almacenamiento solamente. Cuando se identifican intercambios múltiples, consulte la sección de aplicaciones de este catálogo.

COMPETITIVE & O.E.M. INTERCHANGE LIST
Lista de Intercambios contra Competidores y Equipo Original.
Liste d'interchange de produits compétitifs & déquippement original (OEM)

Monroe... cont'd

Monroe	Gabriel	Monroe	Gabriel	Monroe	Gabriel	Monroe	Gabriel
34729	61546	34812	G64121	37040	G63347	37187	82035
34729MM	61520	34814	G63673	37041	77662	37207	58412
34730	61520	34817	61525	37044	G63488	37243	G63610
34730	G63386	34817	G63355	37045	G63183	37290	G64042
34730MM	61520	34821	61547	37048	G63492	37320	61500
34731	61547	34822	G63306	37049	G63355	37320	81147
34731	61554	34824	61524	37050	G63489	37803	G63306
34732	61614	34831	61523	37053	G63386	471128L	G57206
34732	G63455	34839	58357	37055	G63455	471128R	G57206
34736	61525	34839	61517	37063	61555	550010	G63375
34741	61544	34853	61632	37063	77375	550019	G63918
34750	58359	34900	61521	37063	81713	550051	43140
34750	61523	34900	G63386	37078	77907	550061	58412
34751	G63607	34901	G63387	37085	G63896	551002	83122
34756	61543	34904	G63299	37086	77638	551002	89406
34760	58622	34905	61500	37087	G63638	553002	G56778
34760	61591	34905	G63405	37089	G63350	553003	G57802
34760	G63622	34905MM	61500	37090	G63357	555004	G63299
34761	58623	34906	61521	37091	G63413	555010	77623
34761	61646	34910	61516	37093	G63359	555012	G63183
34761	G63623	34910	61522	37094	G63353	555019	85069
34763	58638	34910	81496	37095	G63410	555019	89455
34763	61565	34911	61518	37096	G63359	555031	77614
34763	61687	34911	G63350	37098	G63299	555031	G63622
34763MM	61565	34912	G63625	37102	G63661	555032	G63623
34768	83209	34919	G63411	37103	G63413	555033	G63386
34768	89414	34920	58412	37103	G63662	555034	G63387
34770	61713	34920	61642	37104	G63673	555035	G63357
34771	81342	34927	61554	37104	G63674	555036	77403
34776	61599	34927	G63409	37105	G63662	555038	77403
34777	58662	34928	61546	371128L	G57206	555045	G63394
34777	61600	34929	58403	371128R	G57206	557001	83209
34777MM	61600	34929	G63403	37116	G63622	557001	85013
34778	61634	34930	61530	37117	G63623	557001	89414
34781	61642	34944	61516	37125	G63489	557005	83136
34782	61635	34958	61519	37128	58622	557006	83136
34782	77674	34960	G63366	37128	58929	557007	83122
34791	G63692	34963	61547	37130	G63609	557007	85010
34793	61520	34964	61530	37138	G63403	557007	89406
34793MM	61520	34972	G63610	37140	G63403	557008	85029
34794	61523	34972MM	G63610	37144	61614	557011	83160
34796	58929	34983	58489	37149	G63783	557012	85029
34796	61591	34983	61544	37149ST	G63783	557013	83127
34797	61547	34985	58488	37150	58662	557014	83126
34798	58609	34985	61543	37150	61600	557014	89430
34798	61542	37015	G63614	37150	77662	557015	83209
34798	77609	37015ST	G63614	37150	81873	557015	89414
34799	61542	37018	G63614	37152	G63675	557017	85029
34800	G64043	37024	G63610	37152ST	G63675	557018	83127
34802	83216	37029	G63492	37163	G63783	557020	83123
34802MM	83216	37035	77607	37163	G63817	557020	89405
34803	61500	37035	G63607	37164	G63675	557026	83127
34803	G63306	37036	G63410	37172	61506	557028	85010
34803MM	61500	37037	G63409	37181	58817	557031	85010
34810	G64148	37038	G63461	37181	61663	557033	85900
34811	G64121	37039	G63461	37181	81925	557038	85125

Important Note: Competitive Interchanges are to be used for stocking purposes only. Where multiple crosses are identified, please reference the applications section of this catalog. / **Remarque importante:** Les interchanges concurrentiels ne s'utilisent qu'aux fins de stocks. Dans le cas de références multiples, consulter la section des applications du catalogue. / **Nota importante:** Dans le cas de références multiples, consulter la section des applications du catalogue. / **Nota importante:** Se pueden usar intercambios competitivos para propósitos de almacenamiento solamente. Cuando se identifican intercambios múltiples, consulte la sección de aplicaciones de este catálogo.

COMPETITIVE & O.E.M. INTERCHANGE LIST
Lista de Intercambios contra Competidores y Equipo Original.
Liste d'interchange de produits compétitifs & équipement original (OEM)

Monroe... cont'd

Monroe	Gabriel	Monroe	Gabriel	Monroe	Gabriel	Monroe	Gabriel
571128L	G57206	65148	89449	65479	89406	66418	89449
571128R	G57206	65148M0R	85918	65481	89405	66419	89458
5751	82026	65153	85921	65482	85006	66420	G64164
5803	81340	65155	83175	65482M0R	85006	66422	83163
5803	82066	65156	85005	65483	85978	66422M0R	83163
5818	82155	65156	89430	65484	85976	66429	85311
58241	34036	65161	83136	65487	85927	66429	89424
58253	34058	65164	85649	65488	85656	66430	83309
5826	81270	65167	58944	65489	85331	66433	85918
58263	34073	65167	G63969	65490	85724	66433	89449
58273	34073	65168	77968	65490	89443	66434	85069
58510	43140	65172	89413	65490M0R	85724	66434	89455
58518	43099	65175	85084	65492	89458	66439	G64177
58567	43048	65175	89460	65503	85919	66445	83135
58568	43140	65175M0R	85084	65504	85072	66447	83180
58578	43111	65176	85084	65504M0R	85072	66448	85058
58592	43058	65176	89460	65506	83168	66448	89431
58595	43085	65177	85012	65507	83143	66451	G64177
58600	43163	65177	89413	65508	83142	66452	G64177
58601	43167	65181	85650	65514	89405	66453	G64089
58606	43180	65183	85181	65516	85013	66454	83166
58610	43181	65184	85180	65516	89414	66455	83166
58612	43180	65185	85180	65526	85956	6668	85009
58615	43181	65401	85013	65528	85069	66601	83114
58618	43167	65401	89414	65528	89455	66602	G63610
58636	43181	65402	85311	65528M0R	85069	66603	83103
58637	43181	65402	89424	65530	85932	66604	83101
58654	43181	65402M0R	85311	65530	89453	66605	83613
5969	61555	65411	89405	65530M0R	85932	66613	83123
5969	81713	65412	83122	65543	89443	66613	89405
6025	83122	65412	89406	65547	85650	66615	83120
6025	89406	65413	83136	65548	85106	66618	83159
65109	85058	65420	85013	65549	85642	66620	83162
65109	89431	65420	89414	65552	85188	66624	83141
65110	85005	65420M0R	85013	65554	85670	66625	83162
65110	89430	65421	89430	6603	83103	66626	85071
65110M0R	85005	65434	85012	6604	83101	66628	83136
65110MM	85005	65434	89413	6605	83613	66630	83216
65110MM	89430	65434M0R	85012	66104	83021	66631	83140
65111	85006	65436	85900	66120	85006	66632	83006
65113	85012	65436M0R	85900	6613	83123	66633	83127
65113	89413	65439	85716	6613	89405	66636	83127
65113M0R	85012	65444	85311	6615	83120	66636M0R	83127
65114	89405	65444	89424	66160	83054	66638	83123
65119	85029	65444M0R	85311	66161	83054	66638	89405
65120	85010	65451	85029	66162	83025	66639	G63610
65128	85031	65453	85043	66181	83025	66646	83308
65139	85918	65455	85716	66200	83066	66653	83515
65139	89449	65459	85043	66402	83157	66658	85009
65140	85918	65464	85716	66403	83154	66661	83123
65140	89449	65468	85069	66405	83154	66661	89405
65142	83131	65468	89455	66407	83134	66664	83215
65143	83163	65468M0R	85069	66412	83169	66666	G63671
65144	85928	65478	85058	66414	G64089	66668	83312
65144M0R	85928	65478	89431	66415	G63918	66668	89409
65148	85918	65479	83122	66418	85918	66671	83123

Important Note: Competitive Interchanges are to be used for stocking purposes only. Where multiple crosses are identified, please reference the applications section of this catalog. / **Remarque importante:** Les interchanges concurrentiels ne s'utilisent qu'aux fins de stocks. Dans le cas de références multiples, consulter la section des applications du catalogue. / **Nota importante:** Dans le cas de références multiples, consulter la section des applications du catalogue. / **Nota importante:** Se pueden usar intercambios competitivos para propósitos de almacenamiento solamente. Cuando se identifican intercambios múltiples, consulte la sección de aplicaciones de este catálogo.

COMPETITIVE & O.E.M. INTERCHANGE LIST
Lista de Intercambios contra Competidores y Equipo Original.
Liste d'interchange de produits compétitifs & déquipement original (OEM)

Monroe... cont'd

Monroe	Gabriel	Monroe	Gabriel	Monroe	Gabriel	Monroe	Gabriel
66671	89405	6721	83103	74416	85705	911195	58809
66672	83209	6811	83312	74416	89447	911195	61655
66672	89414	6811	89409	74417	85311	911195	77809
66675	83515	6811MM	83312	74417	89424	911196	77810
66677	83114	6811MM	89409	74425	85724	911198	G63673
66680	83317	6817	G63355	74425	89443	911221	77949
66681	83025	6824	G63349	74429	85919	911222	77950
66683	83101	6829	83103	74433	85331	911223	77948
66692	83120	6833	83126	74454	89425	911255	61684
66697	83164	6833	89430	74454MM	89425	911256	61683
66701	83215	6839	G63357	74473	85716	911257	G63895
66707	83215	6841	83216	74474	89430	911265	61713
66710	83209	6860	83308	911034	G63410	911266	77951
66710	89414	6860MM	83308	911038	77461	911268	G63888
66710M0R	83209	6861	83309	911039	G63456	911300	G64043
66714	83216	6863	83314	911043	G63609	911303	G64121
66714MM	83216	6868	G63360	911044	58488	911447	G64148
66717	83515	6878	83221	911044	61543	911502	77412
66717	85716	6891	83215	911044	81667	911503	77783
66717MM	83515	6894	83209	911050	58489	911504	77662
66721	83391	6894	89414	911050	61544	911507	77817
66722	83518	6897	83126	911050	81668	911511	77609
66811	83312	6897	89430	911055	77455	911512	77488
66811	89409	6900	G63386	911085	G63896	911513	77489
66828	83159	6901	G63387	911086	G63897	911530	77907
66829	83103	6901MM	G63387	911096	G63360	911533	77976
66833	83126	6910	G63413	911102	77661	911534	77980
66833	89430	6911	G63350	911103	G63662	911535	G64013
66841	83216	6916	83123	911104	77673	AMS65128	85031
66841MM	83216	6916	89405	911128	77608	AMS65140	85918
66858	G63183	6920	G63411	911140	77403	AMS65142	83131
66860	83308	6923	83456	911144	61614	AMS65143	83163
66860MM	83308	6923	89447	911149	61641	AMS65148	85918
66861	83309	6927	G63409	911149	81920	AMS65155	83175
66861MM	83309	6956	83101	911150	58662	AMS65402	85311
66863	83314	6957	83225	911150	61600	AMS65420	85013
66878	83221	6960	G63366	911150	81873	AMS65434	85012
66878M0R	83221	6969	83126	911152	58412	AMS65436	85900
66883	83314	6969	89430	911152	61642	AMS65444	85311
66891	83215	6994	83122	911152	81921	AMS65451	85029
66894	83137	6994	89406	911152MM	G63675	AMS65459	85043
66897	83126	70123	85716	911163	61641	AMS65468	85069
66897	89430	70127	85006	911163	81920	AMS65482	85006
66923	83456	70128	85006	911164	G63675	AMS65483	85978
66923	89447	70162	85716	911166	58930	AMS65484	85976
66924	83317	70164	85716	911168	G63675	AMS65487	85927
66924MM	83317	70331	89425	911172	G63492	AMS65489	85331
66956	83101	70332	83314	911173	77807	AMS65490	85724
66957	83225	70397	85006	911174	G63607	AMS65503	85919
66969	83126	70651	85013	911175	G63809	AMS65504	85072
66969	89430	70651	89414	911176	77837	AMS65528	85069
6701	83215	70663	85013	911181	G63817	AMS65530	85932
6707	83215	70663	89414	911190	G63609	AMS66104	83021
6710	83209	74003	89425	911192	77675	AMS66162	83025
6710	89414	74070	85716	911193	61635	AMS66403	83154
6714	83216	74080	85332	911194	G63808	AMS66445	83135

Important Note: Competitive Interchanges are to be used for stocking purposes only. Where multiple crosses are identified, please reference the applications section of this catalog. / **Remarque importante:** Les interchanges concurrentiels ne s'utilisent qu'aux fins de stocks. Dans le cas de références multiples, consulter la section des applications du catalogue. / **Nota importante:** Dans le cas de références multiples, consulter la section des applications du catalogue. / **Nota importante:** Se pueden usar intercambios competitivos para propósitos de almacenamiento solamente. Cuando se identifican intercambios múltiples, consulte la sección de aplicaciones de este catálogo.

COMPETITIVE & O.E.M. INTERCHANGE LIST
Lista de Intercambios contra Competidores y Equipo Original.
Liste d'interchange de produits compétitifs & équipement original (OEM)

Monroe... cont'd

Monroe	Gabriel	Monroe	Gabriel	Monroe	Gabriel	Monroe	Gabriel
AMS66603	83103	AMS66897	83126	MA812	49311	SC2915	6802SE
AMS66605	83613	AMS66923	83456	MA815	49205	SC2928	6804SE
AMS66613	83123	AMS66924	83317	MA817	49212	SC2953	6804SE
AMS66615	83120	AMS66956	83101	MA828	49235	SC2955	6828SE
AMS66624	83141	AMS66969	83126	MA834	49235	SC2961	6850SE
AMS66628	83136	MA700	49205	MONRS55042	77951	SC2961	6854SE
AMS66636	83127	MA726	49173	MONRS55274	77412	SC2961	6855SE
AMS66683	83101	MA730	49127	MONRS55288	77817	SC2963	6803SE
AMS66710	83209	MA733	49149	MONSC2955	6828SE	SC2963	6853SE
AMS66828	83159	MA743	49155	SA1930	6802SE	SC2964	6847SE
AMS66833	83126	MA764	49218	SC2911	6804SE	SC2965	6856SE
AMS66861	83309	MA777	49178	SC2912	6802SE	SC2967	14072
AMS66878	83221	MA779	49231	SC2913	14017	SC2975	6828SE
AMS66891	83215	MA805	49203	SC2913	6804SE		

MOOG

MOOG	Gabriel	MOOG	Gabriel	MOOG	Gabriel	MOOG	Gabriel
SSD131	6856SE						

Mor-Ryde Suspension

Mor-Ryde Suspension	Gabriel	Mor-Ryde Suspension	Gabriel	Mor-Ryde Suspension	Gabriel	Mor-Ryde Suspension	Gabriel
U0109-007	G63183	U0109007	G63183				

Motorcraft

Motorcraft	Gabriel	Motorcraft	Gabriel	Motorcraft	Gabriel	Motorcraft	Gabriel
AA-483	G63837	ASH-121	G63607	ASH-335	G63969	AT-579	G63809
AA-484	G63837	ASH-122	G63614	ASH-36	85716	AT-610	G63461
AA-485	G63837	ASH-1228	83209	ASH-362	G63607	AT-611	G63461
AA-486	G63607	ASH-1228	89414	ASH-38	89425	AT-620	83209
AA-494	83131	ASH-1230	83122	ASH-387	G63809	AT-620	89414
AA-500	G63809	ASH-1230	89406	ASH-391	G63809	AT-621	83122
AA-501	G63809	ASH-132	G63614	ASH-394	G63614	AT-621	89406
AA-502	G63614	ASH-137	83122	ASH-397	83131	AT-696	83140
AA-503	G63614	ASH-137	89406	ASH-398	85928	AT-710	G63809
AA-504	G63614	ASH-23415	G63969	ASH-407	G63809	AT-713	G63614
AA-615	83135	ASH-23454	G63614	ASH-408	G63809	AT-715	G63614
AA-616	83175	ASH-23458	G63614	ASH-684	G63623	AT-716	G63809
AA-617	85928	ASH-24401	G63809	ASH-69	83175	AT-766	83209
AS-485G	G63622	ASH-24402	85928	ASH-706	G63614	AT-766	89414
AS1020G	G63386	ASH-24433	G63837	ASH-707	G63614	AT-811	83135
AS200	G63350	ASH-24434	G63607	ASHV-1000	G63614	AT619G	G63410
AS954G	G63299	ASH-24438	6828SE	ASHV-1015	G63622	AX-267A	83309
ASH-1022	83209	ASH-24492	83175	ASHV-1025	G63623	AX-269A	83308
ASH-1022	89414	ASH-24659	85181	ASHV-1031	G63692	AX-269A	83312
ASH-1023	83122	ASH-24660	85180	ASHV-1047	G63607	AX-269A	89409
ASH-1023	89406	ASH-25	83309	ASHV-1051	G63837	AX-282A	85010
ASH-1129	14072	ASH-25822	83209	ASHV-14	G63837	AX-310	83215
ASH-1130	G63622	ASH-25822	89414	ASHV-6	G63809	AX-332	85928
ASH-1131	G63622	ASH-25823	83209	ASHV-865	G63808	AX-79A	83221
ASH-1132	G63622	ASH-25823	89414	ASHV-866	G63810	AX-97A	83122
ASH-1135	G63623	ASH-25824	83122	ASHV-867	G63455	AX-97A	85005
ASH-1136	G63623	ASH-25824	89406	ASHV-871	G63809	AX-97A	89406
ASH-1154	G63622	ASH-25825	83122	ASHV-879	G63455	AX-97A	89430
ASH-1155	G63623	ASH-25825	89406	ASHV-9	G63375	CAH-003	83215
ASH-119	G63809	ASH-26	85006	AT-110	G63387	CAHL-417	85311
ASH-120	G63837	ASH-29	83314	AT-147	G63350	CAHL-417	89424
ASH-1205	83209	ASH-294	83209	AT-163G	G63622		
ASH-1205	89414	ASH-294	89414	AT-164G	G63623		
ASH-1206	83122	ASH-322	77969	AT-507G	G63607		
ASH-1206	89406	ASH-324	77968	AT-568	G63622		

Important Note: Competitive Interchanges are to be used for stocking purposes only. Where multiple crosses are identified, please reference the applications section of this catalog. / **Remarque importante:** Les interchanges concurrentiels ne s'utilisent qu'aux fins de stocks. Dans le cas de références multiples, consulter la section des applications du catalogue. / **Nota importante:** Dans le cas de références multiples, consulter la section des applications du catalogue. / **Nota importante:** Se pueden usar intercambios competitivos para propósitos de almacenamiento solamente. Cuando se identifican intercambios múltiples, consulte la sección de aplicaciones de este catálogo.

COMPETITIVE & O.E.M. INTERCHANGE LIST
Lista de Intercambios contra Competidores y Equipo Original.
Liste d'interchange de produits compétitifs & déquippement original (OEM)

Motorcraft... cont'd

Motorcraft	Gabriel	Motorcraft	Gabriel	Motorcraft	Gabriel	Motorcraft	Gabriel
CAT-730	G63386	CAT-832	G63353	CAT-958	G63377	CAX-863	83314
CAT-731	G63409	CAT-839	G63357	CAT-960	G63366	CAX-878	83221
CAT-732	G63455	CAT-853	G63183	CAT-964	G63456	CAX-891	83215
CAT-736	G63394	CAT-868	G63360	CAT-972	G63610	CAX-891	89425
CAT-741	G63489	CAT-900	G63386	CAT-983	G63489	CAX-893	85043
CAT-745	G63614	CAT-901	G63387	CAT-984	G63609	CAX-894	83209
CAT-750	G63359	CAT-904	G63299	CAT-985	G63488	CAX-894	85005
CAT-751	G63607	CAT-905	G63405	CAT-986	G63489	CAX-894	85013
CAT-760	G63622	CAT-910	G63413	CAX-707	83215	CAX-894	89414
CAT-761	G63623	CAT-911	G63350	CAX-710	83209	CAX-894	89430
CAT-762	G63638	CAT-912	G63625	CAX-710	89414	CAX-898	85006
CAT-768	83209	CAT-919	G63411	CAX-811	83312	CAX-916	83123
CAT-768	89414	CAT-920	G63675	CAX-811	89409	CAX-916	89405
CAT-776	G63661	CAT-926	G63410	CAX-828	85012	CAX-923	83456
CAT-777	G63662	CAT-927	G63409	CAX-828	89413	CAX-923	89447
CAT-778	G63673	CAT-928	G63410	CAX-833	85005	CAX-924	83317
CAT-803	G63306	CAT-929	G63403	CAX-833	89430	CAX-957	83225
CAT-817	G63355	CAT-930	G63461	CAX-841	83216	CAX-969	83221
CAT-824	G63349	CAT-944	G63347	CAX-860	83308	CLT-109	G63614
CAT-831	G63359	CAT-953	G63375	CAX-861	83309	CLT-124	G63610

Muncie Reclamation

Muncie Reclamation	Gabriel	Muncie Reclamation	Gabriel	Muncie Reclamation	Gabriel	Muncie Reclamation	Gabriel
665459	89447	MR3306	85705	MR3306	89447		

NAPA

NAPA	Gabriel	NAPA	Gabriel	NAPA	Gabriel	NAPA	Gabriel
LS57206	G57206	SH81039	81039	SH81667	81667	SH81925	81925
LS57800	G57800	SH81082	81082	SH81668	81668	SH81928	81928
LS57801	G57801	SH81091	81091	SH81676	81676	SH82003	82003
SH61506	61506	SH81096	81096	SH81710	81710	SH82007	82007
SH61546	61546	SH81113	81113	SH81713	81713	SH82012	82012
SH61614	61614	SH81147	81147	SH81726	81726	SH82026	82026
SH61654	61654	SH81164	81164	SH81744	81744	SH82035	82035
SH61655	61655	SH81242	81242	SH81821	81821	SH82047	82047
SH61656	61656	SH81318	81318	SH81825	81825	SH82065	82065
SH63614	G63614	SH81340	81340	SH81828	81828	SH82066	82066
SH63692	G63692	SH81394	81394	SH81834	81834	SH82086	82086
SH63809	G63809	SH81484	81484	SH81873	81873	SH82155	82155
SH63837	G63837	SH81490	81490	SH81919	81919		
SH64042	G64042	SH81496	81496	SH81920	81920		
SH64043	G64043	SH81510	81510	SH81921	81921		

National RV Inc.

National RV Inc.	Gabriel	National RV Inc.	Gabriel	National RV Inc.	Gabriel	National RV Inc.	Gabriel
1C34-18045-AA	83209	9U9418080AA	83122	ASH-1206	83122	ASH-25824	83122
1C34-18045-AA	89414	9U9418080AA	89406	ASH-1206	89406	ASH-25824	89406
1C34-18045-JA	83209	9U9Z-18124-A	83209	ASH-1228	83209	ASH-294	83209
1C34-18045-JA	89414	9U9Z-18124-A	89414	ASH-1228	89414	ASH-294	89414
24-153249	85125	9U9Z-18125-A	83122	ASH-1229	83209	ASH1023	83122
24-153256	85124	9U9Z-18125-A	89406	ASH-1229	89414	ASH1023	89406
24-186629	85125	9U9Z18125A	83122	ASH-1230	83122	ASH1206	83122
24153249	85125	9U9Z18125A	89406	ASH-1230	89406	ASH1206	89406
24153256	85124	ASH-1022	83209	ASH-137	83122	ASH1230	83122
24186629	85125	ASH-1022	89414	ASH-137	89406	ASH1230	89406
9U94-18045-AA	83209	ASH-1023	83122	ASH-25822	83209	ASH137	83122
9U94-18045-AA	89414	ASH-1023	89406	ASH-25822	89414	ASH137	89406
9U94-18080-AA	83122	ASH-1205	83209	ASH-25823	83209	ASH25824	83122
9U94-18080-AA	89406	ASH-1205	89414	ASH-25823	89414	ASH25824	89406

Important Note: Competitive Interchanges are to be used for stocking purposes only. Where multiple crosses are identified, please reference the applications section of this catalog. / **Remarque importante:** Les interchanges concurrentiels ne s'utilisent qu'aux fins de stocks. Dans le cas de références multiples, consulter la section des applications du catalogue. / **Nota importante:** Dans le cas de références multiples, consulter la section des applications du catalogue. / **Nota importante:** Se pueden usar intercambios competitivos para propósitos de almacenamiento solamente. Cuando se identifican intercambios múltiples, consulte la sección de aplicaciones de este catálogo.

COMPETITIVE & O.E.M. INTERCHANGE LIST
Lista de Intercambios contra Competidores y Equipo Original.
Liste d'interchange de produits compétitifs & déquippement original (OEM)

National RV Inc.... cont'd

National RV Inc.	Gabriel	National RV Inc.	Gabriel	National RV Inc.	Gabriel	National RV Inc.	Gabriel
AT-620	83209	AT-766	89414	F4-BE5-F324-HO	85125	F4BE5F325HO	85124
AT-620	89414	AT621	83122	F4-BE5-F325-HO	85124	W0005662	85125
AT-621	83122	AT621	89406	F4BE5A832MO	85125	W0005663	85124
AT-621	89406	F4-BE5-A832-MO	85125	F4BE5B492HO	85125	W0006254	85125
AT-766	83209	F4-BE5-B492-HO	85125	F4BE5F324HO	85125		

NAVISTAR

NAVISTAR	Gabriel	NAVISTAR	Gabriel	NAVISTAR	Gabriel	NAVISTAR	Gabriel
H60675002	85979						

Neoplan Bus

Neoplan Bus	Gabriel	Neoplan Bus	Gabriel	Neoplan Bus	Gabriel	Neoplan Bus	Gabriel
24-1700-106-149	83216	AA1002002	85705	AC1002003	85705	DZ1002002	85705
24-1700-999-362	85009	AA1002002	89447	AC1002003	89447	DZ1002002	89447
241700106149	83216	AA1002003	85705	BN1002002	85009	GJ1002003	85705
241700999362	85009	AA1002003	89447	BT1002011	83216	GJ1002003	89447
25-1700-101-426	85705	AA1802002	85705	CI 1002003	85705	MM1002002	85705
25-1700-101-426	89447	AA1802002	89447	CI 1002003	89447	MM1002002	89447
251700101426	85705	AC1002002	85705	CL1002003	85705	MM1002003	85705
251700101426	89447	AC1002002	89447	CL1002003	89447	MM1002003	89447
680307	85705	AC1002002GS	85705	DT1802002	85705		
680307	89447	AC1002002GS	89447	DT1802002	89447		

New Flyer

New Flyer	Gabriel	New Flyer	Gabriel	New Flyer	Gabriel	New Flyer	Gabriel
68027440Y	85716	68050440X	85716				

Newmar Corp

Newmar Corp	Gabriel	Newmar Corp	Gabriel	Newmar Corp	Gabriel	Newmar Corp	Gabriel
141700131809	85029	1616736000	85029	ASH-1229	83209	ASH-25824	83122
141700131810	83160	1616737000	83160	ASH-1229	89414	ASH-25824	89406
16-16736-000	85029	1616874000	83160	ASH-25822	83209	ASH25824	83122
16-16737-000	83160	1618103000	85900	ASH-25822	89414	ASH25824	89406
16-16874-000	83160	481700000490	85900	ASH-25823	83209		
16-18103-000	85900	481700000493	85900	ASH-25823	89414		

Nexus RV

Nexus RV	Gabriel	Nexus RV	Gabriel	Nexus RV	Gabriel	Nexus RV	Gabriel
ASH-1136	G63623	ASH-25822	83209	ASH-25824	83122	ASH25824	89406
ASH-1154	G63622	ASH-25822	89414	ASH-25824	89406		
ASH-1229	83209	ASH-25823	83209	ASH1154	G63622		
ASH-1229	89414	ASH-25823	89414	ASH25824	83122		

Nissan

Nissan	Gabriel	Nissan	Gabriel	Nissan	Gabriel	Nissan	Gabriel
56101-30Z02	G63610	56110-Z5014	83162	56200-2Z325	G63299	56200-8Z826	61506
56101-Z5008	83114	56110-Z5017	83162	56200-6B025	G63299	56200-8Z827	61506
56101-Z5014	83162	56110Z5008	83114	56200-7B025	G63299	56200-9Z825	61506
56101-Z5017	83162	56110Z5014	83162	56200-7B085	G63299	E6200-1PA0D	G64164
56101Z5008	83114	56110Z5017	83162	56200-7Z025	61506	E6200-1PA1A	G64164
56101Z5014	83162	56200-0B027	G63299	56200-7Z225	61506	E6200-1PB0A	G64164
56101Z5017	83162	56200-0B028	G63299	56200-7Z285	61506	E6B00-1B02J-NW	G63299
56110-30Z02	G63610	56200-1B026	G63299	56200-8Z425	61506	E6B00-1Z62J-NW	G63492
56110-Z5008	83114	56200-1Z625	61506	56200-8Z625	61506		
56110-Z5011	G63610	56200-1Z626	61506	56200-8Z825	61506		

O'Reilly

O'Reilly	Gabriel	O'Reilly	Gabriel	O'Reilly	Gabriel	O'Reilly	Gabriel
20418	81726	20719	81496	20751	81147	31094	61500
20433	81928	20722	81676	20766	81744	31131	61632
20704	81242	20744	81668	20801	81713		
20711	81113	20745	81667	20851	81318		
20713	81164	20747	81490	23073	81394		
20718	81039	20748	81710	31000	61506		

Important Note: Competitive Interchanges are to be used for stocking purposes only. Where multiple crosses are identified, please reference the applications section of this catalog. / **Remarque importante:** Les interchanges concurrentiels ne s'utilisent qu'aux fins de stocks. Dans le cas de références multiples, consulter la section des applications du catalogue. / **Nota importante:** Dans le cas de références multiples, consulter la section des applications du catalogue. / **Nota importante:** Se pueden usar intercambios competitivos para propósitos de almacenamiento solamente. Cuando se identifican intercambios múltiples, consulte la sección de aplicaciones de este catálogo.

COMPETITIVE & O.E.M. INTERCHANGE LIST
Lista de Intercambios contra Competidores y Equipo Original.
Liste d'interchange de produits compétitifs & déquippement original (OEM)

O'Reilly... cont'd

O'Reilly	Gabriel	O'Reilly	Gabriel	O'Reilly	Gabriel	O'Reilly	Gabriel
32066	61555	32279	81919	32401	61710	37073	G63492
32075	61521	32288	81821	32402	61714	37091	G63413
32080	61518	32294	61547	32402	61716	37094	G63353
32126	81340	32301	82003	33033	61525	37095	G63410
32126	82155	32322	61614	33074	61516	37096	G63359
32164	61519	32325	61530	33076	61517	37102	G63661
32164	81484	32326	61641	33084	61524	37104	G63673
32207	82007	32326	81920	33086	61522	37117	G63623
32224	61544	32326	81921	33275	61592	37130	G63609
32225	61543	32329	61642	33CH1111	G57206	37149	G63783
322268	61646	32350	61663	33CH1112	G57206	37152	G63675
32227	61520	32350	81925	33CH4111	G57206	37187	82035
32228	61554	32357	61654	33VW1104	G57206	37290	G64042
32231	81082	32358	61655	33VW1105	G57206	40040	81873
32259	61591	32359	61656	34762	G63896	5751	82026
32263	61542	32362	61685	34791	G63692	66417	G63918
32265	61687	32366	61635	34831	81096	911039	G63456
32266	61565	32376	81834	34912	G63625	911267	G63888
32268	81828	32385	81091	34919	G63411	911299	G64043
32277	61599	32386	61546	37044	G63488		
32279	61634	32386	81510	37050	G63489		

Orion Bus Industries

Orion Bus Industries	Gabriel	Orion Bus Industries	Gabriel	Orion Bus Industries	Gabriel	Orion Bus Industries	Gabriel
050134501-4	85716	0502315014	85716	050231507	85716	97999902636	85716
0501345014	85716	050231502-4	85716	680274	85716	OB020764	85716
050230501	85716	0502315024	85716	680504	85716		
050231501-4	85716	050231505	85716	97-9999-02636	85716		

Oshkosh Motors

Oshkosh Motors	Gabriel	Oshkosh Motors	Gabriel	Oshkosh Motors	Gabriel	Oshkosh Motors	Gabriel
060670-018	83166	26228-A	89406	40-5348	89431	651444	83221
1202-0054	83021	26228A	83122	400242	83312	665060	83122
12020054	83021	26228A	89406	400242	89409	665060	89406
1398980	83127	3638112	G63183	405348	85058	P117099	83120
1573280	83221	40-0242	83312	405348	89431		
1745500	89430	40-0242	89409	60670-018	83166		
26228-A	83122	40-5348	85058	60670018	83166		

PACCAR

PACCAR	Gabriel	PACCAR	Gabriel	PACCAR	Gabriel	PACCAR	Gabriel
08849AE	85989						

Page Suspension

Page Suspension	Gabriel	Page Suspension	Gabriel	Page Suspension	Gabriel	Page Suspension	Gabriel
665267	85029	A-2212	85029	A2212	85029		

PAI Corp

PAI Corp	Gabriel	PAI Corp	Gabriel	PAI Corp	Gabriel	PAI Corp	Gabriel
HSA-5080	83221	HSA-5095	83215	HSA5080	83221	HSA5095	83215

Peterbilt

Peterbilt	Gabriel	Peterbilt	Gabriel	Peterbilt	Gabriel	Peterbilt	Gabriel
02-01759	83312	02-02738	89413	02-02739-2	89414	02-04010	89413
02-01759	89409	02-02738-2	85012	02-02739PLUS	85013	02-04010-2	85012
02-01890	85012	02-02738-2	89413	02-02739PLUS	89414	02-04010-2	89413
02-01890	89413	02-02738PLUS	85012	02-02740	89405	02-0739PLUS-2	85013
02-02061	85013	02-02738PLUS	89413	02-02740-2	89405	02-0739PLUS-2	89414
02-02061	89414	02-02738PLUS-2	85012	02-02741	85012	0201759	83312
02-02142	89405	02-02738PLUS-2	89413	02-02741-2	85012		
02-02225	85012	02-02739	85013	02-02741-2	89413		
02-02225	89413	02-02739	89414				
02-02738	85012	02-02739-2	85013				

Important Note: Competitive Interchanges are to be used for stocking purposes only. Where multiple crosses are identified, please reference the applications section of this catalog. / **Remarque importante:** Les interchanges concurrentiels ne s'utilisent qu'aux fins de stocks. Dans le cas de références multiples, consulter la section des applications du catalogue. / **Nota importante:** Dans le cas de références multiples, consulter la section des applications du catalogue. / **Nota importante:** Se pueden usar intercambios competitivos para propósitos de almacenamiento solamente. Cuando se identifican intercambios múltiples, consulte la sección de aplicaciones de este catálogo.

COMPETITIVE & O.E.M. INTERCHANGE LIST
Lista de Intercambios contra Competidores y Equipo Original.
Liste d'interchange de produits compétitifs & équipement original (OEM)

Peterbilt... cont'd

Peterbilt	Gabriel	Peterbilt	Gabriel	Peterbilt	Gabriel	Peterbilt	Gabriel
0201759	89409	0307281	85311	60670-008L	89405	680241	89424
0201890	85012	0307281	89424	60670-008PLUS	83123	680253	89425
0201890	89413	0307421	85311	60670-008PLUS	89405	680279	83209
0202061	85013	0307421	89424	60670-008PLUS-2	83123	680279	89414
0202061	89414	0307421PLUS	85311	60670-008PLUS-2	89405	680348	85012
0202142	89405	0307421PLUS	89424	60670005PLUS	83137	680348	89413
0202225	85012	0307421PLUS2	85311	60670008	83123	680459	85311
0202225	89413	0307421PLUS2	89424	60670008	89405	680459	89424
0202738	85012	0307421SPL	85311	60670008L	83123	680586	85311
0202738	89413	0307421SPL	89424	60670008L	89405	680586	89424
02027382	85012	0307424	85311	60670008PLUS	83123	70701PLUS	85900
02027382	89413	0307424	89424	60670008PLUS	89405	85013A0C	85013
0202738PLUS	85012	0307424PLUS	85311	60680-004	83143	85013A0C	89414
0202738PLUS	89413	0307424PLUS	89424	60680-004L	83143	85013ac0	85013
0202738PLUS2	85012	0308781	85069	60680-005	83142	85013ac0	89414
0202738PLUS2	89413	0308781	89455	60680-005L	83142	90044025PLUS	83209
0202739	85013	03087812	85069	60680004	83143	90044025PLUS	89414
0202739	89414	03087812	89455	60680004L	83143	ACHB966	83136
02027392	85013	1201-0054	83021	60680005	83142	B71-1000	85031
02027392	89414	12010054	83021	60680005L	83142	B71-1003	83312
0202739PLUS	85013	1202-0054	83021	665617	85031	B71-1003	89409
0202739PLUS	89414	1202-1044	83025	665617-2	85031	B71-6002	85012
0202740	89405	12020054	83021	6656172	85031	B71-6002	89413
02027402	89405	12021044	83025	665632	85013	B71-6002-2	85012
0202741	85012	12887-01	85013	665632	89414	B71-6002-2	89413
0202741	89413	12887-01	89414	665656	85012	B71-6003	85029
02027412	85012	12887-02	85013	665656	89413	B71-6003-2	85029
02027412	89413	12887-02	89414	665657	85013	B71-6004	85084
0204010	85012	1288701	85013	665657	89414	B71-6004	89460
0204010	89413	1288701	89414	665658	89405	B71-6005	85084
02040102	85012	1288702	85013	665662	85012	B71-6005	89460
02040102	89413	1288702	89414	665662	89413	B71-6006	85084
020739PLUS2	85013	16725-01	83126	665762	85012	B71-6006	89460
020739PLUS2	89414	16725-01	89430	665762	89413	B71-6006	83312
03-04629	85311	1672501	83126	665783	83123	B71-6008	89409
03-04629	89424	1672501	89430	665783	89405	B71-6013	85012
03-07281	85311	1707378PAC	85182	665784	83122	B71-6013	89413
03-07281	89424	19495-01	83126	665784	89406	B71-6015	85012
03-07421	85311	19495-01	89430	665785	83137	B71-6015	89413
03-07421	89424	1949501	83126	665826	85069	B71-6016	85012
03-07421PLUS	85311	1949501	89430	665826	89455	B71-6016	89413
03-07421PLUS	89424	23-12262	85012	665844	85069	B71-6016A	85012
03-07421PLUS-2	85311	23-12262	89413	665844	89455	B71-6016A	89413
03-07421PLUS-2	89424	2312262	85012	665918	85900	B71-6018	85012
03-07421SPL	85311	2312262	89413	665931	83312	B71-6018	89413
03-07421SPL	89424	47902-13PLUS	83122	665931	89409	B71-6019	85989
03-07424	85311	47902-13PLUS	89406	665932	85012	B71-6020	85989
03-07424	89424	47902-13PLUS-2	83122	665932	89413	B711000	85031
03-07424PLUS	85311	47902-13PLUS-2	89406	665945	85902	B711003	83312
03-07424PLUS	89424	4790213PLUS	83122	665945-2	85902	B711003	89409
03-08781	85069	4790213PLUS	89406	665950	85902	B716002	85012
03-08781	89455	60670-005PLUS	83137	671091	85069	B716002	89413
03-08781-2	85069	60670-005PLUS-2	83137	671091	89455	B7160022	85012
03-08781-2	89455	60670-008	83123	671092	85012	B7160022	89413
0304629	85311	60670-008	89405	671092	89413	B716003	85029
0304629	89424	60670-008L	83123	680241	85311	B716004	85084

Important Note: Competitive Interchanges are to be used for stocking purposes only. Where multiple crosses are identified, please reference the applications section of this catalog. / **Remarque importante:** Les interchanges concurrentiels ne s'utilisent qu'aux fins de stocks. Dans le cas de références multiples, consulter la section des applications du catalogue. / **Nota importante:** Dans le cas de références multiples, consulter la section des applications du catalogue. / **Nota importante:** Se pueden usar intercambios competitivos para propósitos de almacenamiento solamente. Cuando se identifican intercambios múltiples, consulte la sección de aplicaciones de este catálogo.

COMPETITIVE & O.E.M. INTERCHANGE LIST
Lista de Intercambios contra Competidores y Equipo Original.
Liste d'interchange de produits compétitifs & déquippement original (OEM)

Peterbilt... cont'd

Peterbilt	Gabriel	Peterbilt	Gabriel	Peterbilt	Gabriel	Peterbilt	Gabriel
B716004	89460	B716018	89413	C71-6003	85988	C716005	85069
B716005	85084	B716019	85989	C71-6005	85069	C716005	89455
B716005	89460	B716020	85989	C71-6005	89455	K374-10-2	83215
B716006	85084	BFRG 072	85182	C711011	85069	K374-28PLUS	89425
B716006	89460	C71-1011	85069	C711011	89455	K374-33-2	83312
B716008	83312	C71-1011	89455	C711011PLUS	85069	K374-33-2	89409
B716008	89409	C71-1011PLUS	85069	C711011PLUS	89455	K374-33PLUS	83312
B716013	85012	C71-1011PLUS	89455	C711011PLUS2	85069	K374-33PLUS	89409
B716013	89413	C71-1011PLUS-2	85069	C711011PLUS2	89455	K374-33PLUS-2	83312
B716015	85012	C71-1011PLUS-2	89455	C711011SPL	85069	K374-33PLUS-2	89409
B716015	89413	C71-1011SPL	85069	C711011SPL	89455	K374102	83215
B716016	85012	C71-1011SPL	89455	C711017	85069	K37428PLUS	89425
B716016	89413	C71-1017	85069	C711017	89455	K37433PLUS	83312
B716016A	85012	C71-1017	89455	C716002	85311	K37433PLUS	89409
B716016A	89413	C71-6002	85311	C716002	89424	TK19679	83126
B716018	85012	C71-6002	89424	C716003	85988	TK19679	89430

Phoenix Cruiser RV

Phoenix Cruiser RV	Gabriel	Phoenix Cruiser RV	Gabriel	Phoenix Cruiser RV	Gabriel	Phoenix Cruiser RV	Gabriel
ASH-1136	G63623	ASH-1154	G63622				

Pierce Manufacturing Inc

Pierce Manufacturing Inc	Gabriel	Pierce Manufacturing Inc	Gabriel	Pierce Manufacturing Inc	Gabriel	Pierce Manufacturing Inc	Gabriel
1201-9008	83054	400242	83312	60680-004L	83143	ASH-866127	77986
12019008	83054	400242	89409	60680-005	83142	ASH-866139	77986
2509223C91	83054	405348	85058	60680-005L	83142	H60657003	85072
2509223C92	83054	405348	89431	60680004	83143	H60675-003	85976
3514952C1	85976	60657-003	85072	60680004L	83143	H60675003	85976
3576464C2	85957	60657-003L	85072	60680005	83142	HC3Z-18125-EP	77986
3626571C2	85072	60657003	85072	60680005L	83142	HC3Z-18125-X	77986
40-0242	83312	60657003L	85072	6127088C1	83163	HDR60680-005	83142
40-0242	89409	60675-003	85976	6127713C2	85656	HDR60680005	83142
40-3089	83312	60675-003L	85976	6127714C1	85928	LC3Z-18125-J	77986
40-3089	89409	60675003	85976	9HE302	85919	LC3Z-18125-W	77986
40-5348	85058	60675003L	85976	ASH-85789	77986		
40-5348	89431	60680-004	83143	ASH-85927	77986		

ProPar

ProPar	Gabriel	ProPar	Gabriel	ProPar	Gabriel	ProPar	Gabriel
PROSH83122	83122	PROSH85005	89430	PROSH85069	85069	PROSH85919	85919
PROSH83122	89406	PROSH85006	85006	PROSH85069	89455	PROSH85923	89458
PROSH83127	83127	PROSH85012	85012	PROSH85311	85311	PROSH85932	85932
PROSH85005	85005	PROSH85012	89413	PROSH85311	89424	PROSH85932	89453

PRT (ADD)

PRT (ADD)	Gabriel	PRT (ADD)	Gabriel	PRT (ADD)	Gabriel	PRT (ADD)	Gabriel
170132	85724	170228	G63969	170263	85071	173504	61685
170132	89443	170237	83136	170264	83515	173504	81668
170148	83456	170243	85069	170469	G63809	173504	81713
170148	89447	170243	89455	170996	81270	173505	61543
170198	81744	170245	83122	171295	83137	173505	61565
170207	81510	170245	89406	171384	81096	173505	81667
170211	85058	170246	83123	172331	61592	173510	61542
170211	89431	170246	89405	173001	61506	173510	61555
170215	85918	170247	85006	173001	81318	173510	81713
170215	89449	170248	83137	173176	61506	173510	81726
170217	83163	170248	85976	173176	81318	173575	61655
170221	85921	170249	85927	173228	61500	173581	61591
170222	83175	170257	G64177	173504	61544	173581	81744
170225	83136	170262	83159	173504	61555	173582	61646

Important Note: Competitive Interchanges are to be used for stocking purposes only. Where multiple crosses are identified, please reference the applications section of this catalog. / **Remarque importante:** Les interchanges concurrentiels ne s'utilisent qu'aux fins de stocks. Dans le cas de références multiples, consulter la section des applications du catalogue. / **Nota importante:** Dans le cas de références multiples, consulter la section des applications du catalogue. / **Nota importante:** Se pueden usar intercambios competitivos para propósitos de almacenamiento solamente. Cuando se identifican intercambios múltiples, consulte la sección de aplicaciones de este catálogo.

COMPETITIVE & O.E.M. INTERCHANGE LIST
Lista de Intercambios contra Competidores y Equipo Original.
Liste d'interchange de produits compétitifs & équipement original (OEM)

PRT (ADD)... cont'd

PRT (ADD)	Gabriel	PRT (ADD)	Gabriel	PRT (ADD)	Gabriel	PRT (ADD)	Gabriel
173582	81828	173859	61680	818616	G57206	925083	83364
173584	61542	173860	61685	818941	G57206	925084	83391
173584	61555	173863	61654	818942	G57206	925085	83395
173584	81726	173894	61687	818983	G57206	925088	83518
173586	61600	173895	81676	818985	G57206	925089	83519
173586	81873	173903	61655	818986	G57206	925090	83613
173616	81496	173933	61713	818991	G57206	925096	85005
173617	61546	173935	G64042	818992	G57206	925096	89430
173621	61635	173939	G64043	920345	G57800	925097	85006
173621	61714	173944	G64121	920346	G57801	925099	85009
173622	61599	173945	G64042	920728	G57853	925100	85012
173622	81928	174044	G63306	920729	G57852	925100	89413
173625	61641	174088	81484	925006	83021	925101	85013
173625	81920	174244	61523	925009	83025	925101	89414
173626	61654	174244	81096	925027	83054	925106	85029
173627	61656	174303	61523	925034	83101	925108	85031
173627	61682	174303	81096	925035	83103	925110	89405
173680	81091	174315	81710	925039	83114	925111	85043
173681	81484	174441	61642	925040	83120	925116	85058
173686	G63387	174441	81921	925041	83122	925116	89431
173687	81744	175075	81039	925041	89406	925124	85069
173690	61591	175357	61642	925042	83123	925124	89455
173690	81744	175357	81921	925042	89405	925126	85071
173696	61641	175441	61710	925045	83126	925127	85072
173696	61663	175448	61682	925045	89430	925131	85084
173696	81920	175449	61713	925046	83131	925131	89460
173696	81921	175450	81744	925047	83134	925137	85106
173696	81925	193575	61655	925048	83135	925142	85124
173697	61642	193577	61565	925049	83136	925143	85125
173697	81921	193577	61687	925050	83137	925145	85180
173698	61642	193581	61591	925051	83140	925146	85181
173698	81921	193581	81744	925052	83141	925155	85311
173704	61614	193582	61646	925053	83142	925155	89424
173708	61500	193582	81828	925054	83143	925156	89425
173708	81147	193698	81921	925057	83154	925162	85331
173735	61565	193706	G63809	925059	83159	925163	85335
173735	61687	193724	81318	925060	83160	925169	85642
173736	61522	193818	G63837	925061	83162	925173	85716
173736	81496	193819	61663	925063	83166	925175	85724
173738	81091	193834	G63607	925064	83169	925175	89443
173739	81164	194267	61642	925065	83175	925178	85900
173769	61634	194267	81921	925066	G63622	925181	85918
173769	81919	194432	81667	925067	G63623	925181	89449
173802	61710	194511	G63625	925068	83180	925182	85919
173802	61716	370018	G64148	925070	83209	925184	85656
173821	G63918	473944	G64121	925070	89414	925185	85927
173825	61714	475331	G56778	925071	83215	925186	85928
173826	61641	476007	G56778	925072	83216	925187	85932
173826	61663	583052	6850SE	925074	83221	925187	89453
173826	81920	583053	6847SE	925075	83225	925188	85956
173826	81925	583059	6847SE	925078	83308	925193	85976
173832	61565	583060	6853SE	925079	83309	925199	G63306
173839	61683	584027	6856SE	925080	83312	925208	G63610
173841	61684	816681	G57206	925080	89409	925210	85902
173841	61685	816682	G57206	925081	83314	925211	85921
173857	G63918	818615	G57206	925082	83317	925212	89458

Important Note: Competitive Interchanges are to be used for stocking purposes only. Where multiple crosses are identified, please reference the applications section of this catalog. / **Remarque importante:** Les interchanges concurrentiels ne s'utilisent qu'aux fins de stocks. Dans le cas de références multiples, consulter la section des applications du catalogue. / **Nota importante:** Dans le cas de références multiples, consulter la section des applications du catalogue. / **Nota importante:** Se pueden usar intercambios competitivos para propósitos de almacenamiento solamente. Cuando se identifican intercambios múltiples, consulte la sección de aplicaciones de este catálogo.

COMPETITIVE & O.E.M. INTERCHANGE LIST
Lista de Intercambios contra Competidores y Equipo Original.
Liste d'interchange de produits compétitifs & déquippement original (OEM)

PRT (ADD)... cont'd

PRT (ADD)	Gabriel	PRT (ADD)	Gabriel	PRT (ADD)	Gabriel	PRT (ADD)	Gabriel
925214	89458	925259	83164	925378	85705	925547	81318
925219	85957	925260	83168	925378	89447	925567	61713
925226	85988	925269	83456	925397	81744	925579	81920
925227	85989	925269	89447	925406	85979	930288	81676
925235	83006	925273	85010	925449	G63456	930848	14072
925250	83127	925292	85332	925525	61682	932803	61655
925255	83148	925339	89430	925531	61685		

Rameriz Trailer

Rameriz Trailer	Gabriel	Rameriz Trailer	Gabriel	Rameriz Trailer	Gabriel	Rameriz Trailer	Gabriel
18165-01	85006	1816501	85006				

Rancho

Rancho	Gabriel	Rancho	Gabriel	Rancho	Gabriel	Rancho	Gabriel
RS5039	G63614	RS5124	G63638	RS5248	G63403	RS7112	G63456
RS5042	G63886	RS5132	G63675	RS5262	G63662	RS7118	77907
RS5045	G63888	RS5136	G63386	RS5262	G63674	RS7150	77609
RS5111	G63183	RS5147	G63403	RS5265	G63783	RS7190	77488
RS5112	G63692	RS5150	G63609	RS5267	G63809	RS7254	77952
RS5113	G63413	RS5151	G63347	RS5295	G63817	RS7267	77809
RS5115	G63387	RS5151	G63411	RS5368	G64043	RS7269	77950
RS5116	G63353	RS5165	G63455	RS5385	G63837	RS7272	77807
RS5116	G63492	RS5166	G63489	RS5410	6854SE	RS7295	77817
RS5117	G63350	RS5190	G63488	RS5413	6856SE	RS97488	6855SE
RS5117	G63461	RS5195	G63661	RS7042	77951	RS999120	58357
RS5118	G63349	RS5197	G63673	RS7044	77674		
RS5118	G63409	RS5199	G63359	RS7044	77948		
RS5120	G63357	RS5221	G64009	RS7044	77980		

Renegade RV

Renegade RV	Gabriel	Renegade RV	Gabriel	Renegade RV	Gabriel	Renegade RV	Gabriel
10-13976-000	85918	16-16764-000	85724	1616764000	85724	SDA471700002809	85724
10-13976-000	89449	16-16764-000	89443	1616764000	89443	SDA471700002809	89443
1013976000	85918	16-18708-000	85724	1618708000	85724		
1013976000	89449	16-18708-000	89443	1618708000	89443		

Reyco Suspension

Reyco Suspension	Gabriel	Reyco Suspension	Gabriel	Reyco Suspension	Gabriel	Reyco Suspension	Gabriel
12887-01	85013	17146-01	83209	1740801	85005	1949501	89430
12887-01	89414	17146-01	89414	1740801	89430	19623-01	83123
12887-02	85013	1714601	83209	17794-01	83215	19623-01	89405
12887-02	89414	1714601	89414	1779401	83215	1962301	83123
1288701	85013	17358-01	83126	18164-01	83122	1962301	89405
1288701	89414	17358-01	89430	18164-01	89406	19824-01	85006
1288702	85013	1735801	83126	1816401	83122	1982401	85006
1288702	89414	1735801	89430	1816401	89406	21497-01	85005
16725-01	83126	17403-01	83122	18165-01	85006	21497-01	89430
16725-01	89430	17403-01	89406	1816501	85006	2149701	85005
1672501	83126	1740301	83122	18286-01	89414	2149701	89430
1672501	89430	1740301	89406	19495-01	83126	23106-01	89430
16824-01	85006	17408-01	85005	19495-01	89430	665519	89414
1682401	85006	17408-01	89430	1949501	83126		

Ridewell Corp

Ridewell Corp	Gabriel	Ridewell Corp	Gabriel	Ridewell Corp	Gabriel	Ridewell Corp	Gabriel
1250546B000	85006	57645	85005	AS30698	85005	AS575B	85005
1253069B000	85005	57645	89430	AS30698	89430	AS575B	89430
1253069B000	89430	665198	85005	AS3069B	85005		
1275943B	85005	665198	89430	AS3069B	89430		
1275943B	89430	665267	85029	AS546B	85006		

Important Note: Competitive Interchanges are to be used for stocking purposes only. Where multiple crosses are identified, please reference the applications section of this catalog. / **Remarque importante:** Les interchanges concurrentiels ne s'utilisent qu'aux fins de stocks. Dans le cas de références multiples, consulter la section des applications du catalogue. / **Nota importante:** Dans le cas de références multiples, consulter la section des applications du catalogue. / **Nota importante:** Se pueden usar intercambios competitivos para propósitos de almacenamiento solamente. Cuando se identifican intercambios múltiples, consulte la sección de aplicaciones de este catálogo.

COMPETITIVE & O.E.M. INTERCHANGE LIST
Lista de Intercambios contra Competidores y Equipo Original.
Liste d'interchange de produits compétitifs & équipement original (OEM)

RIG TOUGH

RIG TOUGH	Gabriel	RIG TOUGH	Gabriel	RIG TOUGH	Gabriel	RIG TOUGH	Gabriel
0202738RTB	85012	0307421RTB	85311	C711011RTB	85069		

Sabo

Sabo	Gabriel	Sabo	Gabriel	Sabo	Gabriel	Sabo	Gabriel
8901024	89425	8901029	89443	8901033	85918	8901156	G63299
8901029	85724	8901031	85900	8901033	89449		

Sachs

Sachs	Gabriel	Sachs	Gabriel	Sachs	Gabriel	Sachs	Gabriel
030 202	G63357	311 120	G64043	315546	89430	316834	85058
030 204	G63375	311 212	G63817	315550	85311	316834	89431
030 204	G63894	311229	85918	315550	89424	316837	83312
030 205	G63386	311229	89449	315553	85900	316837	89409
030 215	G63461	311230	85956	315556	83215	316838	83309
030 218	G63607	311633	85900	315593	85029	316839	83215
030 219	G63614	311793	89430	315594	85029	316840	83126
030 221	G63609	312724	85311	315600	85918	316840	89430
030 243	G63350	312724	89424	315600	89449	317 966	G63183
030 244	G63353	313 123	G63610	315603	83134	317529	83154
030 245	G63360	313 625	G64009	315611	85006	317534	85084
030 247	G63377	313 625	G64011	315612	85006	317534	85989
030 248	G63387	314 243	G63673	315617	85918	317534	89460
030 252	G63409	315 925	G64042	315617	89449	317773	85656
030 257	G63455	315390	85918	315618	83160	317774	83122
030 262	G63492	315390	89449	315619	83160	317774	89406
030 767	G63671	315391	85956	315623	85918	317776	83209
030 768	G63411	315393	85331	315623	89449	317776	89414
030 777	G63623	315394	85921	315661	85932	317930	83025
030 780	G63638	315395	85724	315661	89453	317932	83101
030 780	G63896	315395	89443	315840	83126	317933	83103
030 817	G63837	315396	85335	315840	89430	317934	83123
030 878	G63810	315397	83120	316 39	83215	317934	89405
030 879	G63808	315398	85058	316 462	G63888	317935	83142
115 906	G56778	315398	89431	316 638	G63886	317937	83148
141700000378	83160	315399	85005	316 638	G63969	317938	85012
141700131809	85029	315399	89430	316302	83163	317938	89413
141700131810	83160	315400	85006	316303	83136	317939	83314
141700131975	83160	315401	85331	316307	89405	317943	85979
141700131980	83160	315402	85900	316310	85311	317945	83515
152C030010	83317	315403	85919	316310	89424	317956	83025
290 379	G63918	315404	85900	316312	83136	317957	83225
290146	85012	315406	85918	316321	83317	317958	83308
290146	89413	315406	89449	316478	85331	317962	85311
290460	85005	315412	85106	316488	85919	317962	89424
290460	89430	315413	85932	316490	85010	317964	85029
310 173	G63413	315413	89453	316491	85013	317965	83163
310 178	G63661	315417	89458	316491	89414	317966	G63183
310 183	G63359	315418	83456	316493	85010	410010	83317
310 218	G63622	315418	89447	316816	85012	410022	85006
310 284	G63489	315423	83127	316816	89413	410025	83215
310 287	G63488	315432	83209	316820	85012	410026	85918
310 312	G63783	315432	85013	316820	89413	410026	89449
310 315	G63355	315432	89414	316822	85978	410043	85957
310 315	G63366	315540	83613	316823	85072	410044	85031
310 317	G63349	315542	83122	316824	85069	410046	83136
310 325	G63662	315542	85005	316824	89455		
310 325	G63675	315542	89406	316825	83021		
310 328	G63893	315542	89430	316831	85043		
310 350	G63299	315546	85005	316832	83120		

Important Note: Competitive Interchanges are to be used for stocking purposes only. Where multiple crosses are identified, please reference the applications section of this catalog. / **Remarque importante:** Les interchanges concurrentiels ne s'utilisent qu'aux fins de stocks. Dans le cas de références multiples, consulter la section des applications du catalogue. / **Nota importante:** Dans le cas de références multiples, consulter la section des applications du catalogue. / **Nota importante:** Se pueden usar intercambios competitivos para propósitos de almacenamiento solamente. Cuando se identifican intercambios múltiples, consulte la sección de aplicaciones de este catálogo.

COMPETITIVE & O.E.M. INTERCHANGE LIST
Lista de Intercambios contra Competidores y Equipo Original.
Liste d'interchange de produits compétitifs & déquippement original (OEM)

Sachs... cont'd

Sachs	Gabriel	Sachs	Gabriel	Sachs	Gabriel	Sachs	Gabriel
410047	85071	471700002809	85724	471700006270	85932	471700131970	85029
410057	83137	471700002809	89443	471700006270	89453	471700131974	85029
410057	85013	471700002810	85724	471700011530	85181	481700000477	85900
410057	89414	471700002810	89443	471700011531	85180	481700000480	85900
410058	83122	471700002919	85106	471700014318	85188	481700000490	85900
410058	89406	471700002920	85106	471700131155	85918	481700000493	85900
471700000428	85006	471700002992	85331	471700131155	89449	481700125969	85956
471700000447	85919	471700002993	85921	471700131160	85918	481700125970	85956
471700000449	85918	471700002994	83134	471700131160	89449	481700131438	85919
471700000449	89449	471700002995	83134	471700131330	85932	481700131440	85919
471700000450	85918	471700002996	85335	471700131330	89453	481700131919	85900
471700000450	85919	471700003000	85335	471700131331	85932	481700131920	85900
471700000450	89449	471700003009	85006	471700131331	89453	510 007	85705
471700000460	89414	471700003010	89431	471700131545	85006	510006	85705
471700000461	89414	471700003011	85058	471700131646	85918	510006	89447
471700000470	85918	471700003011	89431	471700131646	89449	510018	85724
471700000470	89449	471700005079	85005	471700131650	85918	510018	89443
471700002726	85918	471700005079	89430	471700131650	89449	510019	89430
471700002726	89449	471700005080	89430	471700131775	85006	610 023	G63405
471700002730	85918	471700006269	85932	471700131778	85331	610 078	G63403
471700002730	89449	471700006269	89453	471700131780	85331		

SAF Holland

SAF Holland	Gabriel	SAF Holland	Gabriel	SAF Holland	Gabriel	SAF Holland	Gabriel
471700000460	89414	90044025	83209	90044915	83127	AR-134-C	89430
471700000461	89414	90044025	89414	90045096	89430	AR-1654	83209
481700000483	89430	90044046	83123	90045110	83137	AR-1654	89414
481700000485	89430	90044046	89405	90045175	89430	AR-2598	83123
57643	85013	90044626	83126	90045207	89405	AR-2598	89405
57643	89414	90044626	89430	90045384	89430	AR1008	85006
6025	83122	90044642	83127	90045418	89430	AR134C	85005
6025	89406	90044679	83122	90045419	89405	AR134C	89430
665514	83127	90044679	89406	90045433	89430	AR1654	83209
665969	89430	90044682	83209	90045466	89406	AR1654	89414
671921	89430	90044682	89414	90045500	89430	AR2598	83123
671922	89405	90044683	83122	90045503	89430	AR2598	89405
671931	89430	90044683	89406	90045536	89414	SAF83166SAF	83166
90044001	85005	90044688	83122	90045665	85029		
90044001	89430	90044688	89406	AR-1008	85006		
90044012	85006	90044794	83127	AR-134-C	85005		

Safari Motor Coach

Safari Motor Coach	Gabriel	Safari Motor Coach	Gabriel	Safari Motor Coach	Gabriel	Safari Motor Coach	Gabriel
B462092	83126	B462092	89430	B462093	85058	B462093	89431

SenSen

SenSen	Gabriel	SenSen	Gabriel	SenSen	Gabriel	SenSen	Gabriel
1212-0098	61592	1213-0576	G63411	1214-0138	81667	1214-0175	G63614
1213-0155	G63299	1214-0125	61710	1214-0141	61600	1214-0175	G63622
1213-0188	61516	1214-0125	61716	1214-0141	61642	1214-0176	61685
1213-0188	61525	1214-0126	G63809	1214-0141	81873	1214-0176	81668
1213-0188	81039	1214-0128	G63455	1214-0142	81873	1214-0177	61591
1213-0188	81113	1214-0129	81726	1214-0145	61542	1214-0178	61646
1213-0189	61524	1214-0130	61547	1214-0145	81726	1214-0178	81828
1213-0189	81164	1214-0130	81082	1214-0150	81873	1214-0179	61544
1213-0273	81147	1214-0131	G63456	1214-0151	81921	1214-0179	61555
1213-0332	81744	1214-0132	81667	1214-0154	G63675	1214-0179	81668
1213-0365	81318	1214-0137	81821	1214-0159	G64042	1214-0182	81713
1213-0516	G63918	1214-0138	61543	1214-0174	61714	1214-0184	61546

Important Note: Competitive Interchanges are to be used for stocking purposes only. Where multiple crosses are identified, please reference the applications section of this catalog. / **Remarque importante:** Les interchanges concurrentiels ne s'utilisent qu'aux fins de stocks. Dans le cas de références multiples, consulter la section des applications du catalogue. / **Nota importante:** Dans le cas de références multiples, consulter la section des applications du catalogue. / **Nota importante:** Se pueden usar intercambios competitivos para propósitos de almacenamiento solamente. Cuando se identifican intercambios múltiples, consulte la sección de aplicaciones de este catálogo.

COMPETITIVE & O.E.M. INTERCHANGE LIST
Lista de Intercambios contra Competidores y Equipo Original.
Liste d'interchange de produits compétitifs & déquippement original (OEM)

SenSen... cont'd

SenSen	Gabriel	SenSen	Gabriel	SenSen	Gabriel	SenSen	Gabriel
1214-0184	81490	1214-0199	81925	1214-0253	61713	1214-0418	G63625
1214-0185	61599	1214-0206	G63894	1214-0255	G63888	1214-0420	61530
1214-0185	81928	1214-0210	61654	1214-0273	81147	1214-0428	G64043
1214-0186	61634	1214-0211	61656	1214-0392	G63607	1214-0433	61554
1214-0186	61635	1214-0212	61565	1214-0394	G63837	3214-0185	81744
1214-0186	81919	1214-0213	61687	1214-0395	61517	4214-0167	G56778
1214-0191	61614	1214-0240	81510	1214-0396	61522	4214-0168	G56778
1214-0193	61641	1214-0240	81710	1214-0396	81496	9214-0244	G57206
1214-0193	81920	1214-0252	61680	1214-0408	81484		
1214-0199	61663	1214-0253	61682	1214-0418	G63394		

Shasta RV

Shasta RV	Gabriel	Shasta RV	Gabriel	Shasta RV	Gabriel	Shasta RV	Gabriel
8C24-18045-DA	G63622	8C2Z-18124-D	G63622	ASH-1136	G63623	AT-163G	G63622
8C24-18080-DB	G63623	8C2Z-18125-D	G63623	ASH-1154	G63622	AT-164G	G63623
8C2418045DA	G63622	8C2Z18124D	G63622	ASH1136	G63623	AT163G	G63622
8C2418080DB	G63623	8C2Z18125D	G63623	ASH1154	G63622	AT164G	G63623

Spartan Motors

Spartan Motors	Gabriel	Spartan Motors	Gabriel	Spartan Motors	Gabriel	Spartan Motors	Gabriel
0346-SS5	85013	0377SS5	85029	60665-025L	89405	B461594	85013
0346-SS5	89414	1300B46	85029	60665025L	89405	B461594	89414
0346SS5	85013	2502B46	85013	B46-1594	85013	B461725	85029
0346SS5	89414	2502B46	89414	B46-1594	89414	B462502	85013
0377-SS5	85029	60665-025	89405	B46-1725	85029	B462502	89414

Starcraft Bus Co

Starcraft Bus Co	Gabriel	Starcraft Bus Co	Gabriel	Starcraft Bus Co	Gabriel	Starcraft Bus Co	Gabriel
3578858C1	85656	4C4Z-18125-DA	85656	ASH-1136	G63623	FC44-18045-BB	85181
3578858C2	85656	4C4Z18124JB	85928	ASH-1154	G63622	FC44-18080-AB	85180
3584116C1	83175	4C4Z18124QA	83175	ASH-24658	85181	FC4418045BB	85181
3584116C2	83175	4C4Z18124RA	85928	ASH-24659	85181	FC4418080AB	85180
3584118C2	85928	4C4Z18125B	83317	ASH-24660	85180	FC4Z-18124-A	85181
471700011530	85181	4C4Z18125DA	85656	ASH24658	85181	FC4Z-18124-B	85181
471700011531	85180	501906C92	83317	ASH24659	85181	FC4Z-18125-A	85180
4C4Z-18124-JB	85928	AA-616	83175	ASH24660	85180	FC4Z18124A	85181
4C4Z-18124-QA	83175	AA-617	85928	ASH24661	83317	FC4Z18124B	85181
4C4Z-18124-RA	85928	AA616	83175	AT-812	85928	FC4Z18125A	85180
4C4Z-18125-B	83317	AA617	85928	AT812	85928		

Stellantis

Stellantis	Gabriel	Stellantis	Gabriel	Stellantis	Gabriel	Stellantis	Gabriel
05168284AC	85649	3638 112	G63183	6811 1104AB-001	85649	6818 5556AE	G57800
05168295AB	85649	3638112	G63183	6811 1104AB001	85649	6818 5556AE	G57801
05168296AA	85650	4443 482	81825	6811 1105AC	85649	6824 5775AA	G57800
2516 009	G63183	4721 686AE	G64042	6811 1105AC-001	85649	6824 5775AA	G57801
2516009	G63183	4721 687AB	G64042	6811 1105AC001	85649	6827 0280AA	G57800
2960 707	G63183	4897 443AD	81928	6811 1107AA	85650	6827 0280AA	G57801
2960707	G63183	4897 472AD	81919	6811 1107AA-001	85650	G0060043	81834
2961 043	G63183	6804 0880AG	G64011	6811 1107AA001	85650	MB242146	81147
2961043	G63183	6804 0882AD	G64011	6813 8247AC	G64042	MB515371	81147
3633 643	G63183	6805 7374AA	G64043	6813 8247AE	G64042	SG23086	81496
3633 744	G63183	6806 7325AA	G64043	6814 4549AE	G64042	SG23127	81096
3633643	G63183	6809 2726AA	G64042	6815 7795AD	G57800		
3633744	G63183	6811 1104AB	85649	6815 7795AD	G57801		

Sterling Truck

Sterling Truck	Gabriel	Sterling Truck	Gabriel	Sterling Truck	Gabriel	Sterling Truck	Gabriel
05168284AC	85649	10-13205-000	89449	12021043	83025		
05168295AB	85649	1013205000	85918	16-13957-000	85724		
05168296AA	85650	1013205000	89449	16-13957-000	89443		
10-13205-000	85918	1202-1043	83025	16-15770-000	85956		

Important Note: Competitive Interchanges are to be used for stocking purposes only. Where multiple crosses are identified, please reference the applications section of this catalog. / **Remarque importante:** Les interchanges concurrentiels ne s'utilisent qu'aux fins de stocks. Dans le cas de références multiples, consulter la section des applications du catalogue. / **Nota importante:** Dans le cas de références multiples, consulter la section des applications du catalogue. / **Nota importante:** Se pueden usar intercambios competitivos para propósitos de almacenamiento solamente. Cuando se identifican intercambios múltiples, consulte la sección de aplicaciones de este catálogo.

COMPETITIVE & O.E.M. INTERCHANGE LIST
Lista de Intercambios contra Competidores y Equipo Original.
Liste d'interchange de produits compétitifs & déquippement original (OEM)

Sterling Truck... cont'd

Sterling Truck	Gabriel	Sterling Truck	Gabriel	Sterling Truck	Gabriel	Sterling Truck	Gabriel
16-15817-000	85724	58913-003	85932	AX-267A	83309	F1HZ18124J	83308
16-15817-000	89443	58913-003	89453	AX-310	83215	F4HT-18080-AB	89425
1613957000	85724	58913-003L	85932	AX267A	83309	F4HT18080AB	89425
1613957000	89443	58913-003L	89453	AX310	83215	F5HZ-18124-A	83314
1615770000	85956	58913003	85932	C4HZ-18124-E	83309	F5HZ-18125-A	89425
1615817000	85724	58913003	89453	C4HZ18124E	83309	F5HZ18124A	83314
1615817000	89443	58913003L	85932	C4TZ-18124-AB	83308	F5HZ18125A	89425
471700002810	85724	58913003L	89453	C4TZ18124AB	83308	F6HT-18080-CA	89425
471700002810	89443	6803230300	85006	E6HZ-18125-D	83215	F6HT-18080-FC	85013
471700131331	85932	6803260000	83120	E6HZ18125D	83215	F6HT-18080-FC	89414
471700131331	89453	680339	85724	E7XZ-18124-A	G63386	F6HT18080CA	89425
471700131646	85918	680339	89443	E7XZ-18125-B	G63387	F6HT18080FC	85013
471700131646	89449	680611	85724	E7XZ18124A	G63386	F6HT18080FC	89414
471700131650	85918	680611	89443	E7XZ18125B	G63387	F6HZ-18124-B	83308
471700131650	89449	6811 1104AB	85649	E9HZ-18124-A	83309	F6HZ-18125-D	85013
47902-28	85013	6811 1104AB-001	85649	E9HZ18124A	83309	F6HZ-18125-D	89414
47902-28	89414	6811 1104AB001	85649	F0HZ-18124-B	85006	F6HZ18124B	83308
4790228	85013	6811 1105AC	85649	F0HZ18124B	85006	F6HZ18125D	85013
4790228	89414	6811 1105AC-001	85649	F1HZ-18124-A	83309	F6HZ18125D	89414
481700006850	85724	6811 1105AC001	85649	F1HZ-18124-B	83308	F81A-18045-AGB	G63809
481700006850	89443	6811 1107AA	85650	F1HZ-18124-D	85006	F81A18045AGB	G63809
481700125969	85956	6811 1107AA-001	85650	F1HZ-18124-E	85006	XC45-18045-AA	83216
481700125970	85956	6811 1107AA001	85650	F1HZ-18124-J	83308	XC45-18080-BA	85724
4C4Z-18124-N	85957	6E7Z-18125-A	83364	F1HZ18124A	83309	XC45-18080-BA	89443
4C4Z-18125-DA	85656	6E7Z18125A	83364	F1HZ18124B	83308	XC4518045AA	83216
4C4Z18124N	85957	AT-560	G63809	F1HZ18124D	85006	XC4518080BA	85724
4C4Z18125DA	85656	AT560	G63809	F1HZ18124E	85006	XC4518080BA	89443

Stoughton Trailers Inc

Stoughton Trailers Inc	Gabriel	Stoughton Trailers Inc	Gabriel	Stoughton Trailers Inc	Gabriel	Stoughton Trailers Inc	Gabriel
RT18165-01	85006	RT1816501	85006				

SYD

SYD	Gabriel	SYD	Gabriel	SYD	Gabriel	SYD	Gabriel
7000020	81147	7000058	81668	7000219	6828SE	7000493	G64089
7000039	G63969	7000059	81667	7000247	G63622	7000692	G64148
7000040	77968	7000164	61663	7000248	61646	7000693	G64121
7000044	81490	7000164	81925	7000250	81726	7000719	G56778
7000045	81713	7000166	61641	7000385	G64042	7000721	G63918
7000048	81928	7000166	81920	7000393	81318	7000722	G63918
7000049	61600	7000167	81873	7000397	6847SE		
7000050	61500	7000167	81921	7000406	6853SE		
7000056	81082	7000218	6804SE	7000420	G63809		

The Binkley Company

The Binkley Company	Gabriel	The Binkley Company	Gabriel	The Binkley Company	Gabriel	The Binkley Company	Gabriel
16965	85006						

Thomas

Thomas	Gabriel	Thomas	Gabriel	Thomas	Gabriel	Thomas	Gabriel
10-13211-000	85918	16-18708-000	85724	471700131545	85006	61300240	89449
10-13211-000	89449	16-18708-000	89443	471700131550	85006	61310434	85724
10-13634-000	85918	16-19138-000	85058	60998-001	85006	61310434	89443
10-13634-000	89449	16-19138-000	89431	60998-003	85006	61310478	85724
1013211000	85918	1615817000	85724	60998001	85006	61310478	89443
1013211000	89449	1615817000	89443	60998003	85006	680-323-0300	85006
1013634000	85918	1618708000	85724	61300112	83613	680-326-0000	83120
1013634000	89449	1618708000	89443	61300224	85918	6803230300	85006
16-15817-000	85724	1619138000	85058	61300224	89449	6803260000	83120
16-15817-000	89443	1619138000	89431	61300240	85918	8C24-18045-DA	G63622

Important Note: Competitive Interchanges are to be used for stocking purposes only. Where multiple crosses are identified, please reference the applications section of this catalog. / **Remarque importante:** Les interchanges concurrentiels ne s'utilisent qu'aux fins de stocks. Dans le cas de références multiples, consulter la section des applications du catalogue. / **Nota importante:** Dans le cas de références multiples, consulter la section des applications du catalogue. / **Nota importante:** Se pueden usar intercambios competitivos para propósitos de almacenamiento solamente. Cuando se identifican intercambios múltiples, consulte la sección de aplicaciones de este catálogo.

COMPETITIVE & O.E.M. INTERCHANGE LIST
Lista de Intercambios contra Competidores y Equipo Original.
Liste d'interchange de produits compétitifs & équipement original (OEM)

Thomas... cont'd

Thomas	Gabriel	Thomas	Gabriel	Thomas	Gabriel	Thomas	Gabriel
8C24-18080-DB	G63623	ASH-1136	G63623	AT-164G	G63623		
8C2Z-18124-D	G63622	ASH-1154	G63622	GBL654725	83120		
8C2Z-18125-D	G63623	AT-163G	G63622	GBL665538	85006		

Thor Motor Coach

Thor Motor Coach	Gabriel	Thor Motor Coach	Gabriel	Thor Motor Coach	Gabriel	Thor Motor Coach	Gabriel
10-13976-000	85918	8C2Z-18124-D	G63622	ASH-1228	89414	ASH1229	89414
10-13976-000	89449	8C2Z-18125-D	G63623	ASH-1229	83209	ASH1230	83122
1013976000	85918	8C2Z18124D	G63622	ASH-1229	89414	ASH1230	89406
1013976000	89449	8C2Z18125D	G63623	ASH-1230	83122	ASH137	83122
141700131809	85029	9U94-18045-AA	83209	ASH-1230	89406	ASH137	89406
141700131810	83160	9U94-18045-AA	89414	ASH-137	83122	ASH25820	85005
16-16736-000	85029	9U94-18080-AA	83122	ASH-137	89406	ASH25820	89430
16-16737-000	83160	9U94-18080-AA	89406	ASH-25820	85005	ASH25821	85006
16-16764-000	85724	9U9418045AA	83209	ASH-25820	89430	ASH25822	83209
16-16764-000	89443	9U9418045AA	89414	ASH-25821	85006	ASH25822	89414
16-16873-000	85029	9U9418080AA	83122	ASH-25822	83209	ASH25823	83209
16-16874-000	83160	9U9418080AA	89406	ASH-25822	89414	ASH25823	89414
16-18103-000	85900	9U9Z-18124-A	83209	ASH-25823	83209	ASH25824	83122
1616736000	85029	9U9Z-18124-A	89414	ASH-25823	89414	ASH25824	89406
1616737000	83160	9U9Z-18125-A	83122	ASH-25824	83122	ASH294	83209
1616764000	85724	9U9Z-18125-A	89406	ASH-25824	89406	ASH294	89414
1616764000	89443	9U9Z18124A	83209	ASH-294	83209	AT-163G	G63622
1616873000	85029	9U9Z18124A	89414	ASH-294	89414	AT-164G	G63623
1616874000	83160	9U9Z18125A	83122	ASH1022	83209	AT-620	83209
1618103000	85900	9U9Z18125A	89406	ASH1022	89414	AT-620	89414
1C34-18045-AA	83209	ASH-1022	83209	ASH1023	83122	AT-621	83122
1C34-18045-AA	89414	ASH-1022	89414	ASH1023	89406	AT-621	89406
1C34-18045-JA	83209	ASH-1023	83122	ASH1136	G63623	AT-766	83209
1C34-18045-JA	89414	ASH-1023	89406	ASH1154	G63622	AT-766	89414
1C3418045AA	83209	ASH-1136	G63623	ASH1161	85006	AT163G	G63622
1C3418045AA	89414	ASH-1154	G63622	ASH1162	85005	AT164G	G63623
1C3418045JA	83209	ASH-1161	85006	ASH1162	89430	AT620	83209
1C3418045JA	89414	ASH-1162	85005	ASH1205	83209	AT620	89414
481700000490	85900	ASH-1162	89430	ASH1205	89414	AT621	83122
481700000493	85900	ASH-1205	83209	ASH1206	83122	AT621	89406
8C24-18045-DA	G63622	ASH-1205	89414	ASH1206	89406	AT766	83209
8C24-18080-DB	G63623	ASH-1206	83122	ASH1228	83209	AT766	89414
8C2418045DA	G63622	ASH-1206	89406	ASH1228	89414		
8C2418080DB	G63623	ASH-1228	83209	ASH1229	83209		

Tiffin Motorhomes Inc

Tiffin Motorhomes Inc	Gabriel	Tiffin Motorhomes Inc	Gabriel	Tiffin Motorhomes Inc	Gabriel	Tiffin Motorhomes Inc	Gabriel
10-13976-000	85918	1013976000	85918	16-16764-000	85724	1616764000	85724
10-13976-000	89449	1013976000	89449	16-16764-000	89443	1616764000	89443

Tokico

Tokico	Gabriel	Tokico	Gabriel	Tokico	Gabriel	Tokico	Gabriel
2518	G63492	E3816	G63492				

Trailmobile Canada Corp

Trailmobile Canada Corp	Gabriel	Trailmobile Canada Corp	Gabriel	Trailmobile Canada Corp	Gabriel	Trailmobile Canada Corp	Gabriel
43-4-236	85029	43-8-014	85013	436137	85006	438015	85006
43-4-241	85006	43-8-014	89414	436158	85013	438022	83225
43-6-137	85006	43-8-015	85006	436158	89414	438031	85029
43-6-158	85013	43-8-022	83225	438002	83209	90044642	83127
43-6-158	89414	43-8-031	85029	438002	89414	A-2212	85029
43-8-002	83209	434236	85029	438014	85013	A2212	85029
43-8-002	89414	434241	85006	438014	89414		

Important Note: Competitive Interchanges are to be used for stocking purposes only. Where multiple crosses are identified, please reference the applications section of this catalog. / **Remarque importante:** Les interchanges concurrentiels ne s'utilisent qu'aux fins de stocks. Dans le cas de références multiples, consulter la section des applications du catalogue. / **Nota importante:** Dans le cas de références multiples, consulter la section des applications du catalogue. / **Nota importante:** Se pueden usar intercambios competitivos para propósitos de almacenamiento solamente. Cuando se identifican intercambios múltiples, consulte la sección de aplicaciones de este catálogo.

COMPETITIVE & O.E.M. INTERCHANGE LIST
Lista de Intercambios contra Competidores y Equipo Original.
Liste d'interchange de produits compétitifs & déquippement original (OEM)

TRIANGLE GROUP

TRIANGLE GROUP	Gabriel	TRIANGLE GROUP	Gabriel	TRIANGLE GROUP	Gabriel	TRIANGLE GROUP	Gabriel
F65528	85069						

TRP

TRP	Gabriel	TRP	Gabriel	TRP	Gabriel	TRP	Gabriel
89405GSK	89405	89443GSK	89443	HS 85058	85058	HS 85900	85900
89406GSK	89406	89449GSK	89449	HS 85058	89431	HS 85918	85918
89409GSK	89409	HS 85005	85005	HS 85069	85069	HS 85918	89449
89413GSK	89413	HS 85005	89430	HS 85069	89455	HS 85919	85919
89414GSK	89414	HS 85006	85006	HS 85311	85311	HS 85931	89458
89424GSK	89424	HS 85012	85012	HS 85311	89424		
89430GSK	89430	HS 85012	89413	HS 85724	85724		
89431GSK	89431	HS 85029	85029	HS 85724	89443		

Truckmaster

Truckmaster	Gabriel	Truckmaster	Gabriel	Truckmaster	Gabriel	Truckmaster	Gabriel
665632	85013	665844	85069	665950	85902	680348	89413
665632	89414	665844	89455	680241	85311	680385	85311
665783	83123	665918	85900	680241	89424	680385	89424
665783	89405	665931	83312	680253	89425	680586	85311
665784	83122	665931	89409	680279	83209	680586	89424
665784	89406	665932	85012	680279	89414	680601	85012
665785	83137	665932	89413	680348	85012	680601	89413

TRW

TRW	Gabriel	TRW	Gabriel	TRW	Gabriel	TRW	Gabriel
JGM4264S	G56778	JGT4106S	81270	JGT4450S	G63783	JGT5024S	G63405
JGP4006S	G63783	JGT4156S	G63671	JGT4452S	G63355	JGT5028S	G63609
JGS4208S	G64009	JGT4158S	G63411	JGT4452S	G63366	JGT5034S	81082
JGS4208S	G64011	JGT4168S	G63623	JGT4454S	G63349	JGT5040S	81713
JGT4006S	G63357	JGT4170S	G63638	JGT4456S	G63662	JGT5060S	81668
JGT4008S	G63375	JGT4170S	G63896	JGT4456S	G63675	JGT5064S	81667
JGT4008S	G63894	JGT4194S	G63837	JGT4458S	G63893	JGT5076S	81113
JGT4010S	G63386	JGT4228S	G63810	JGT4462S	G63299	JGT5078S	81873
JGT4024S	G63461	JGT4240S	G63810	JGT4482S	G64043	JGT5084S	81318
JGT4026S	G63607	JGT4242S	G63808	JGT4490S	G63817	JGT5086S	G63403
JGT4028S	G63614	JGT4400S	G63413	JGT4556S	81318	JGT5088S	81490
JGT4030S	G63614	JGT4404S	G63661	JGT4622S	G63610	JGT5090S	81920
JGT4032S	G63609	JGT4406S	G63359	JGT4724S	G63673	JGT5574S	82155
JGT4058S	G63350	JGT4418S	G63614	JGT4846S	G64042	JGT5578S	G63461
JGT4060S	G63353	JGT4418S	G63622	JGT4880S	G63888	JGT5994S	G63403
JGT4062S	G63360	JGT4430S	G63614	JGT4920S	G63886	JGT6038S	G63662
JGT4066S	G63377	JGT4430S	G63622	JGT4920S	G63969	JGT6060S	G63492
JGT4068S	G63387	JGT4432S	G63809	JGT4926S	G64121	JHT5168S	G63918
JGT4074S	G63409	JGT4442S	G64042	JGT4994S	G63675	JHT5778S	G63409
JGT4082S	G63455	JGT4446S	G63489	JGT5018S	G63638	JOT5254S	77674
JGT4090S	G63492	JGT4448S	G63488	JGT5020S	81928		

Turtletop Bus

Turtletop Bus	Gabriel	Turtletop Bus	Gabriel	Turtletop Bus	Gabriel	Turtletop Bus	Gabriel
ASH-1136	G63623	ASH-1154	G63622				

Tuthill Technologies

Tuthill Technologies	Gabriel	Tuthill Technologies	Gabriel	Tuthill Technologies	Gabriel	Tuthill Technologies	Gabriel
12887-01	85013	16725-01	89430	17358-01	83126	17408-01	89430
12887-01	89414	1672501	83126	17358-01	89430	1740801	85005
12887-02	85013	1672501	89430	1735801	83126	1740801	89430
12887-02	89414	16824-01	85006	1735801	89430	17794-01	83215
1288701	85013	1682401	85006	17403-01	83122	1779401	83215
1288701	89414	17146-01	83209	17403-01	89406		
1288702	85013	17146-01	89414	1740301	83122		
1288702	89414	1714601	83209	1740301	89406		
16725-01	83126	1714601	89414	17408-01	85005		

Important Note: Competitive Interchanges are to be used for stocking purposes only. Where multiple crosses are identified, please reference the applications section of this catalog. / **Remarque importante:** Les interchanges concurrentiels ne s'utilisent qu'aux fins de stocks. Dans le cas de références multiples, consulter la section des applications du catalogue. / **Nota importante:** Dans le cas de références multiples, consulter la section des applications du catalogue. / **Nota importante:** Se pueden usar intercambios competitivos para propósitos de almacenamiento solamente. Cuando se identifican intercambios múltiples, consulte la sección de aplicaciones de este catálogo.

COMPETITIVE & O.E.M. INTERCHANGE LIST
Lista de Intercambios contra Competidores y Equipo Original.
Liste d'interchange de produits compétitifs & équipement original (OEM)

Tuthill Technologies... cont'd

Tuthill Technologies	Gabriel	Tuthill Technologies	Gabriel	Tuthill Technologies	Gabriel	Tuthill Technologies	Gabriel
18164-01	83122	18286-01	89414	19623-01	89405	21497-01	89430
18164-01	89406	19495-01	83126	1962301	83123	2149701	85005
1816401	83122	19495-01	89430	1962301	89405	2149701	89430
1816401	89406	1949501	83126	19824-01	85006		
18165-01	85006	1949501	89430	1982401	85006		
1816501	85006	19623-01	83123	21497-01	85005		

UD

UD	Gabriel	UD	Gabriel	UD	Gabriel	UD	Gabriel
561000T825	83515	56101-Z5017	83162	56110-30Z02	G63610	56110Z5008	83114
56101-30Z02	G63610	56101Z5008	83114	56110-Z5008	83114	56110Z5014	83162
56101-Z5008	83114	56101Z5014	83162	56110-Z5014	83162	56110Z5017	83162
56101-Z5014	83162	56101Z5017	83162	56110-Z5017	83162	E61000T825	83515

Unity

Unity	Gabriel	Unity	Gabriel	Unity	Gabriel	Unity	Gabriel
11970	G57206	13424	G57852	253050	G64042		
12-199000	G63817	14-510900	49231	254080	G63610		
13423	G57853	252500	G63299	256200	61716		

UPS Truck

UPS Truck	Gabriel	UPS Truck	Gabriel	UPS Truck	Gabriel	UPS Truck	Gabriel
P117099	83120						

Volkswagen

Volkswagen	Gabriel	Volkswagen	Gabriel	Volkswagen	Gabriel	Volkswagen	Gabriel
7B0 513 031 N	G64042	7B0 513 031 P	G64042				

Volvo

Volvo	Gabriel	Volvo	Gabriel	Volvo	Gabriel	Volvo	Gabriel
03-1106460	85005	3199940	89430	37301-0018	85005	3919904	G63183
03-1106460	89430	3199941	85006	37301-0018	89430	3919906	83308
031106460	85005	3199943	85012	373010001	85013	3919907	83309
031106460	89430	3199943	89413	373010001	89414	3919910	83221
1091348	83122	3199944	85006	373010018	85005	3919912	83215
1091348	89406	3199947	85013	373010018	89430	3919914	83209
1091351	83209	3199947	89414	3915948	85311	3919914	89414
1091351	89414	3199948	85311	3915948	89424	3919915	83127
1091353	83215	3199948	89424	3916352	85013	3919916	83126
1091354	83216	3199956	89405	3916352	89414	3919916	89430
1091358	83456	3199957	83122	3919057	83225	3919919	G63625
1091358	89447	3199957	89406	3919526	83314	3919921	83123
1091359	83123	3199962	89425	3919561	89425	3919921	89405
1091359	89405	3199984	89425	3919565	83103	3919924	83456
1091362	83309	3199987	85705	3919567	83613	3919924	89447
1091363	83221	3199987	89447	3919573	83123	3919925	83317
1091364	83312	3199988	85311	3919573	89405	3919926	G63403
1091364	89409	3199988	89424	3919574	85006	3919927	83101
1091370	85006	35901-0001	83209	3919575	83120	3919928	83225
14QK-429M2	85072	35901-0001	89414	3919582	83215	3919931	83126
1593843	83215	35901-0011	83123	3919585	83209	3919931	89430
20782199	85072	35901-0011	89405	3919585	89414	3919939	85058
22314111	89405	35901-0017	83314	3919588	83216	3919939	89431
23159761	85188	35901-3413	85006	3919591	83515	3919940	85005
23159763	85188	359010001	83209	3919598	83312	3919940	89430
23567823	85072	359010001	89414	3919598	89409	3919941	85006
23568046	89405	359010011	83123	3919900	85012	3919943	85012
25624730	85005	359010011	89405	3919900	89413	3919943	89413
25624730	89430	359010017	83314	3919901	83103		
3199939	85058	359013413	85006	3919902	83126		
3199939	89431	37301-0001	85013	3919902	89430		
3199940	85005	37301-0001	89414	3919903	83216		

Important Note: Competitive Interchanges are to be used for stocking purposes only. Where multiple crosses are identified, please reference the applications section of this catalog. / **Remarque importante:** Les interchanges concurrentiels ne s'utilisent qu'aux fins de stocks. Dans le cas de références multiples, consulter la section des applications du catalogue. / **Nota importante:** Dans le cas de références multiples, consulter la section des applications du catalogue. / **Nota importante:** Se pueden usar intercambios competitivos para propósitos de almacenamiento solamente. Cuando se identifican intercambios múltiples, consulte la sección de aplicaciones de este catálogo.

COMPETITIVE & O.E.M. INTERCHANGE LIST
Lista de Intercambios contra Competidores y Equipo Original.
Liste d'interchange de produits compétitifs & déquippement original (OEM)

Volvo... cont'd

Volvo	Gabriel	Volvo	Gabriel	Volvo	Gabriel	Volvo	Gabriel
3919944	89405	60675-001L	85978	83176214	89430	RC SA3216	83216
3919947	85013	60675-13	89405	83176218	89405	RC SA5005	85005
3919947	89414	60675001	85978	83176227	85069	RC SA5005	89430
3919948	85311	60675001L	85978	83176227	89455	RC SA5724	85724
3919948	89424	6067513	89405	83176231	85311	RC SA5724	89443
3919951	83309	60680-004	83143	83176231	89424	RC SA5900	85900
3919956	89405	60680-004L	83143	83176235	85724	RC SA5918	85918
3919957	83122	60680-005	83142	83176235	89443	RC SA5918	89449
3919957	89406	60680-005L	83142	83176236	85900	SA3103	83103
3919973	85956	60680004	83143	83176237	89430	SA3123	83123
3919988	85311	60680004L	83143	83176238	85918	SA3123	89405
3919988	89424	60680005	83142	83176238	89449	SA3126	83126
3945811	89409	60680005L	83142	85104186	85006	SA3126	89430
3945814	89424	66221140I	83215	85106580	85918	SA3127	83127
3945815	89406	668302	83216	85106580	89449	SA3136	83136
3945816	89430	6790756	83215	85107238	85976	SA3148	83148
3945820	89413	8083872	85978	ASH-24446	83215	SA5005	85005
3946210	83103	83176195	83103	ASH24446	83215	SA5005	89430
3946239	85724	83176199	83123	AX-310	83215	SA5036	89405
3946239	89443	83176199	89405	AX310	83215	SA5069	85069
3972662	85976	83176202	83126	D7HT-18080-AA	83215	SA5069	89455
471700014318	85188	83176202	89430	D7HT-18080-DA	83215	SA5311	85311
47902-24	83137	83176203	83127	D7HT18080AA	83215	SA5311	89424
4790224	83137	83176205	83136	D7HT18080DA	83215	SA5724	85724
4940640	83216	83176206	83148	E0HT-18080-AA	83215	SA5724	89443
4975549	83216	83176208	83209	E0HT18080AA	83215	SA5900	85900
5513989	83216	83176208	89414	RC SA3103	83103	SA5916	89430
60657-007	85072	83176209	83215	RC SA3127	83127	SA5918	85918
60657007	85072	83176210	83216	RC SA3136	83136	SA5918	89449
60675-001	85978	83176214	85005	RC SA3148	83148		

Volvo RoadChoice

Volvo RoadChoice	Gabriel	Volvo RoadChoice	Gabriel	Volvo RoadChoice	Gabriel	Volvo RoadChoice	Gabriel
SA3066	83066	SA3148	83148	SA5012	89413	SA5900	85900
SA3103	83103	SA3209	83209	SA5036	89405	SA5916	89430
SA3123	83123	SA3209	89414	SA5069	85069	SA5918	85918
SA3123	89405	SA3215	83215	SA5069	89455	SA5918	89449
SA3126	83126	SA3216	83216	SA5311	85311	SA5931	89458
SA3126	89430	SA5005	85005	SA5311	89424		
SA3127	83127	SA5005	89430	SA5724	85724		
SA3136	83136	SA5012	85012	SA5724	89443		

Wabash National

Wabash National	Gabriel	Wabash National	Gabriel	Wabash National	Gabriel	Wabash National	Gabriel
202447	85919	NEW900-44-626	89430	NEW90044626	83126	NEW90044794	83127
203447	85919	NEW900-44-642	83127	NEW90044626	89430		
NEW900-44-626	83126	NEW900-44-794	83127	NEW90044642	83127		

Watson & Chalin Mfg. Inc

Watson & Chalin Mfg. Inc	Gabriel	Watson & Chalin Mfg. Inc	Gabriel	Watson & Chalin Mfg. Inc	Gabriel	Watson & Chalin Mfg. Inc	Gabriel
10634	G63357	12128	85005	17474	85009		
11724	83123	12128	89430	665727	85005		
11724	89405	17218	85029	665727	89430		

Western Star

Western Star	Gabriel	Western Star	Gabriel	Western Star	Gabriel	Western Star	Gabriel
10-13684-000	85918	16-15770-000	85956	16-18708-000	89443	1618708000	85724
10-13684-000	89449	16-15817-000	85724	1615770000	85956		
1011839	83216	16-15817-000	89443	1615817000	85724		
1013684000	85918	16-18706-000	85331	1615817000	89443		
1013684000	89449	16-18708-000	85724	1618706000	85331		

Important Note: Competitive Interchanges are to be used for stocking purposes only. Where multiple crosses are identified, please reference the applications section of this catalog. / **Remarque importante:** Les interchanges concurrentiels ne s'utilisent qu'aux fins de stocks. Dans le cas de références multiples, consulter la section des applications du catalogue. / **Nota importante:** Dans le cas de références multiples, consulter la section des applications du catalogue. / **Nota importante:** Se pueden usar intercambios competitivos para propósitos de almacenamiento solamente. Cuando se identifican intercambios múltiples, consulte la sección de aplicaciones de este catálogo.

COMPETITIVE & O.E.M. INTERCHANGE LIST
Lista de Intercambios contra Competidores y Equipo Original.
Liste d'interchange de produits compétitifs & équipement original (OEM)

Western Star... cont'd

Western Star	Gabriel	Western Star	Gabriel	Western Star	Gabriel	Western Star	Gabriel
1618708000	89443	471700002809	89443	481700125969	85956	60657-003L	85072
16725-01	83126	471700002810	85724	481700125970	85956	60657003	85072
16725-01	89430	471700002810	89443	57905-1	85976	60657003L	85072
1672501	83126	471700006269	85932	57905-2	85006	60675-002	85979
1672501	89430	471700006269	89453	579051	85976	60675-002L	85979
19495-01	83126	471700006270	85932	579052	85006	60675002	85979
19495-01	89430	471700006270	89453	58913-003	85932	60675002L	85979
1949501	83126	471700131330	85932	58913-003	89453	60680-004	83143
1949501	89430	471700131330	89453	58913-003L	85932	60680-004L	83143
28R010	83216	471700131331	85932	58913-003L	89453	60680-005	83142
35066-4413	83122	471700131331	89453	58913-012	85932	60680-005L	83142
35066-4413	89406	47902-13	83122	58913-012	89453	60680004	83143
350664413	83122	47902-13	89406	58913-012L	85932	60680004L	83143
350664413	89406	47902-24	83137	58913-012L	89453	60680005	83142
35901-0001	83209	47902-8	83122	58913003	85932	60680005L	83142
35901-0001	89414	47902-8	89406	58913003	89453	680611	85724
35901-3413	85006	4790213	83122	58913003L	85932	680611	89443
359010001	83209	4790213	89406	58913003L	89453	90044025	83209
359010001	89414	4790224	83137	58913012	85932	90044025	89414
359013413	85006	479028	83122	58913012	89453	SDA471700002809	85724
471700000470	85918	479028	89406	58913012L	85932	SDA471700002809	89443
471700000470	89449	481700006848	85724	58913012L	89453	SDA481700125969	85956
471700002809	85724	481700006848	89443	60657-003	85072		

Wheeled Coach Ind

Wheeled Coach Ind	Gabriel	Wheeled Coach Ind	Gabriel	Wheeled Coach Ind	Gabriel	Wheeled Coach Ind	Gabriel
ASH-1136	G63623	ASH-1154	G63622	ASH1136	G63623	ASH1154	G63622

Winnebago

Winnebago	Gabriel	Winnebago	Gabriel	Winnebago	Gabriel	Winnebago	Gabriel
141700131809	85029	8C24-18080-DB	G63623	ASH-1023	83122	ASH-294	89414
141700131810	83160	8C2418045DA	G63622	ASH-1023	89406	ASH1022	83209
16-16736-000	85029	8C2418080DB	G63623	ASH-1136	G63623	ASH1022	89414
16-16737-000	83160	8C2Z-18124-D	G63622	ASH-1154	G63622	ASH1023	83122
16-16873-000	85029	8C2Z-18125-D	G63623	ASH-1161	85006	ASH1023	89406
16-16874-000	83160	8C2Z18124D	G63622	ASH-1162	85005	ASH1136	G63623
16-18103-000	85900	8C2Z18125D	G63623	ASH-1162	89430	ASH1154	G63622
1616736000	85029	9U94-18045-AA	83209	ASH-1205	83209	ASH1161	85006
1616737000	83160	9U94-18045-AA	89414	ASH-1205	89414	ASH1162	85005
1616873000	85029	9U94-18080-AA	83122	ASH-1206	83122	ASH1162	89430
1616874000	83160	9U94-18080-AA	89406	ASH-1206	89406	ASH1205	83209
1618103000	85900	9U9418045AA	83209	ASH-1228	83209	ASH1205	89414
1C34-18045-AA	83209	9U9418045AA	89414	ASH-1228	89414	ASH1206	83122
1C34-18045-AA	89414	9U9418080AA	83122	ASH-1229	83209	ASH1206	89406
1C34-18045-JA	83209	9U9418080AA	89406	ASH-1229	89414	ASH1228	83209
1C34-18045-JA	89414	9U9Z-18124-A	83209	ASH-1230	83122	ASH1228	89414
1C3418045AA	83209	9U9Z-18124-A	89414	ASH-1230	89406	ASH1229	83209
1C3418045AA	89414	9U9Z-18125-A	83122	ASH-137	83122	ASH1229	89414
1C3418045JA	83209	9U9Z-18125-A	89406	ASH-137	89406	ASH1230	83122
1C3418045JA	89414	9U9Z-18125-B	83122	ASH-25820	85005	ASH1230	89406
24-153249	85125	9U9Z-18125-B	89406	ASH-25820	89430	ASH137	83122
24-153256	85124	9U9Z18124A	83209	ASH-25821	85006	ASH137	89406
24-186629	85125	9U9Z18124A	89414	ASH-25822	83209	ASH25820	85005
24153249	85125	9U9Z18125A	83122	ASH-25822	89414	ASH25820	89430
24153256	85124	9U9Z18125A	89406	ASH-25823	83209	ASH25821	85006
24186629	85125	9U9Z18125B	83122	ASH-25823	89414		
481700000490	85900	9U9Z18125B	89406	ASH-25824	83122		
481700000493	85900	ASH-1022	83209	ASH-25824	89406		
8C24-18045-DA	G63622	ASH-1022	89414	ASH-294	83209		

Important Note: Competitive Interchanges are to be used for stocking purposes only. Where multiple crosses are identified, please reference the applications section of this catalog. / **Remarque importante:** Les interchanges concurrentiels ne s'utilisent qu'aux fins de stocks. Dans le cas de références multiples, consulter la section des applications du catalogue. / **Nota importante:** Dans le cas de références multiples, consulter la section des applications du catalogue. / **Nota importante:** Se pueden usar intercambios competitivos para propósitos de almacenamiento solamente. Cuando se identifican intercambios múltiples, consulte la sección de aplicaciones de este catálogo.

COMPETITIVE & O.E.M. INTERCHANGE LIST
Lista de Intercambios contra Competidores y Equipo Original.
Liste d'interchange de produits compétitifs & déquippement original (OEM)

Winnebago... cont'd

Winnebago	Gabriel	Winnebago	Gabriel	Winnebago	Gabriel	Winnebago	Gabriel
ASH25822	83209	AT-620	83209	AT621	83122	F4BE5F324HO	85125
ASH25822	89414	AT-620	89414	AT621	89406	F4BE5F325HO	85124
ASH25823	83209	AT-621	83122	AT766	83209	HU9Z-18125-B	83122
ASH25823	89414	AT-621	89406	AT766	89414	HU9Z-18125-B	89406
ASH25824	83122	AT-766	83209	F4-BE5-A832-MO	85125	HU9Z18125B	83122
ASH25824	89406	AT-766	89414	F4-BE5-B492-HO	85125	HU9Z18125B	89406
ASH294	83209	AT163G	G63622	F4-BE5-F324-HO	85125	W0005662	85125
ASH294	89414	AT164G	G63623	F4-BE5-F325-HO	85124	W0005663	85124
AT-163G	G63622	AT620	83209	F4BE5A832MO	85125	W0006254	85125
AT-164G	G63623	AT620	89414	F4BE5B492HO	85125		

Workhorse

Workhorse	Gabriel	Workhorse	Gabriel	Workhorse	Gabriel	Workhorse	Gabriel
24-153249	85125	680672	85919	F4-BE5-F325-HO	85124	W0005663	85124
24-153256	85124	7805-X-1012	85919	F4BE5A832MO	85125	W0006254	85125
24-186629	85125	7805X1012	85919	F4BE5B492HO	85125	W0011635	83221
24153249	85125	F4-BE5-A832-MO	85125	F4BE5F324HO	85125	W0011636	G63366
24153256	85124	F4-BE5-B492-HO	85125	F4BE5F325HO	85124		
24186629	85125	F4-BE5-F324-HO	85125	W0005662	85125		

World Trans Bus Co

World Trans Bus Co	Gabriel	World Trans Bus Co	Gabriel	World Trans Bus Co	Gabriel	World Trans Bus Co	Gabriel
ASH-1136	G63623	ASH-1154	G63622	ASH1136	G63623	ASH1154	G63622

XOS Truck Company

XOS Truck Company	Gabriel	XOS Truck Company	Gabriel	XOS Truck Company	Gabriel	XOS Truck Company	Gabriel
60665-025	89405	60665-025L	89405	60665025	89405	60665025L	89405

ZF

ZF	Gabriel	ZF	Gabriel	ZF	Gabriel	ZF	Gabriel
SAC315390	85918	SAC315395	85724	SAC315542	83122		

Important Note: Competitive Interchanges are to be used for stocking purposes only. Where multiple crosses are identified, please reference the applications section of this catalog. / **Remarque importante:** Les interchanges concurrentiels ne s'utilisent qu'aux fins de stocks. Dans le cas de références multiples, consulter la section des applications du catalogue. / **Nota Importante:** Dans le cas de références multiples, consulter la section des applications du catalogue. / **Nota Importante:** Se pueden usar intercambios competitivos para propósitos de almacenamiento solamente. Cuando se identifican intercambios múltiples, consulte la sección de aplicaciones de este catálogo.

EXPLANATION OF SPECIFICATIONS

- Part Number:** The catalog number for the individual shock absorber.
- Extended Length*:** The length of the shock absorber when it is fully extended. See "How to Measure" instructions.
- Collapsed Length*:** The length of the shock absorber when it is fully collapsed. See "How to Measure" instructions.
- Stroke:** This is the approximate length of the stroke of the individual shock absorber being described.
- Mounting Codes:** Indicates the type of mounting ends for the upper and lower end of each shock absorber.
They are listed as follows:
 Top mounts ("TM")
 Eye ring and bushing with sleeve mounts ("ES")
 Stud type mounts ("S" & "DS")
 Eye ring and bushing with bar pin mounts ("BP")
 Special mounting codes ("SP")
 Eye ring and bushing mounts ("EB")
 Clevis mounts ("CL")
 Pinch socket mounts ("LP")
 U joint mounts ("LU")

CONVERSION CHART

Fraction (Inches)	Decimal (Inches)	Metric (MM)	Fraction (Inches)	Decimal (Inches)	Metric (MM)
1/64	0.016	0.397	33/64	0.516	13.097
1/32	0.031	0.794	17/32	0.531	13.494
3/64	0.047	1.191	35/64	0.547	13.891
1/16	0.063	1.588	9/16	0.563	14.288
5/64	0.078	1.984	37/64	0.578	14.684
3/32	0.094	2.381	19/32	0.594	15.081
7/64	0.109	2.778	39/64	0.609	15.478
1/8	0.125	3.175	5/8	0.625	15.875
9/64	0.141	3.572	41/64	0.641	16.272
5/32	0.156	3.969	21/32	0.656	16.669
11/64	0.172	4.366	43/64	0.672	17.066
3/16	0.188	4.763	11/16	0.688	17.463
13/64	0.203	5.159	45/64	0.703	17.859
7/32	0.219	5.556	23/32	0.719	18.256
15/64	0.234	5.953	47/64	0.734	18.653
1/4	0.250	6.350	3/4	0.750	19.050
17/64	0.266	6.747	49/64	0.766	19.447
9/32	0.281	7.144	25/32	0.781	19.844
19/64	0.297	7.541	51/64	0.797	20.241
5/16	0.313	7.938	13/16	0.813	20.638
21/64	0.328	8.334	53/64	0.828	21.034
11/32	0.344	8.731	27/32	0.844	21.431
23/64	0.359	9.128	55/64	0.859	21.828
3/8	0.375	9.525	7/8	0.875	22.225
25/64	0.391	9.922	57/64	0.891	22.622
13/32	0.406	10.319	29/32	0.906	23.019
27/64	0.422	10.716	59/64	0.922	23.416
7/16	0.438	11.113	15/16	0.938	23.813
29/64	0.453	11.509	61/64	0.953	24.209
15/32	0.469	11.906	31/32	0.969	24.606
31/64	0.484	12.303	63/64	0.984	25.003
1/2	0.500	12.700	1	1.000	25.400

METRIC CONVERSION CHART

MILLIMETERS	INCHES	MILLIMETERS	INCHES	MILLIMETERS	INCHES
1	0.03937	10	0.39370	19	0.74803
2	0.07874	11	0.43307	20	0.78740
3	0.11811	12	0.47244	21	0.82677
4	0.15748	13	0.51181	22	0.86614
5	0.19685	14	0.55118	23	0.90551
6	0.23622	15	0.59055	24	0.94488
7	0.27559	16	0.62992	25	0.98425
8	0.31496	17	0.66929		
9	0.35433	18	0.70866		

HOW TO MEASURE EXTENDED & COLLAPSED LENGTHS OF SHOCK ABSORBERS

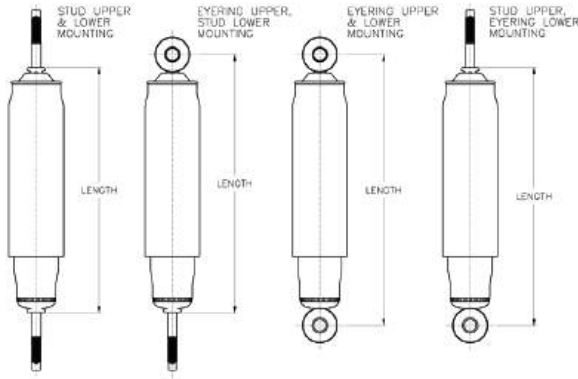

Instructions

1. Using the proper measuring points as shown above find the nearest replacement shock absorber from the listing increments of extended length.
2. Identify the proper mounting form the mounting codes and match these requirements by carefully measuring the mounting dimensions (top and bottom) of the shock absorber to be replaced.
3. Carefully take note of the following requirements:
 - a. **Mounting Accessories** - Contents and descriptions of parts are shown in this manual.
 - b. **Dust tubes** - This requirement should be noted in comparison with the shock absorber to be replaced. Shock absorber environment in its application makes this requirement necessary for piston rod protection and extended shock absorber life.
 - c. **Recoil Cutoff and Compression Bumper** - Carefully note these specifications- deviation of length requirements should not exceed $\pm 1/2$ ". These shock absorber designs are footnoted for easy identification.
 - d. **Limited Environment Application** - Most conventional shock absorbers are offered in "straight" construction to fit limited environment applications. These shock absorber designs are footnoted.

SHOCK ABSORBER DIAMETERS

Shown below are measuring points for diameters by type of shock absorber. Refer to the chart below which lists diameters for the various bore sizes available for each type.

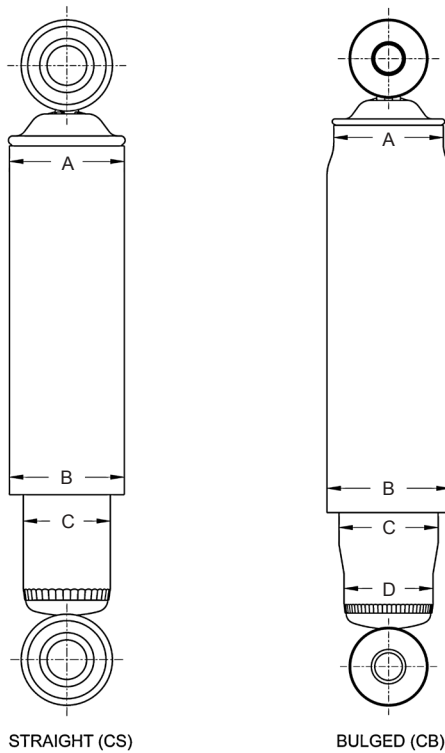

BORE SIZE	SHOCK ABSORBERS	TYPE (Shown Above)	Diameters			
			A	B	C	D
1 3/16"	Classic, Guardian, Ultra Pass. Car	CS	2.06	2.00	1.63	NA
1 3/16"	Classic, Guardian, Ultra Pass. Car	CB	2.06	2.19	1.81	1.63
1 3/8"	Ultra Truck	CS	NA	2.37	2.00	NA
1 3/8"	Ultra Truck	CB	2.37	2.50	2.19	2.00

EXTERNAL DIMENSIONS

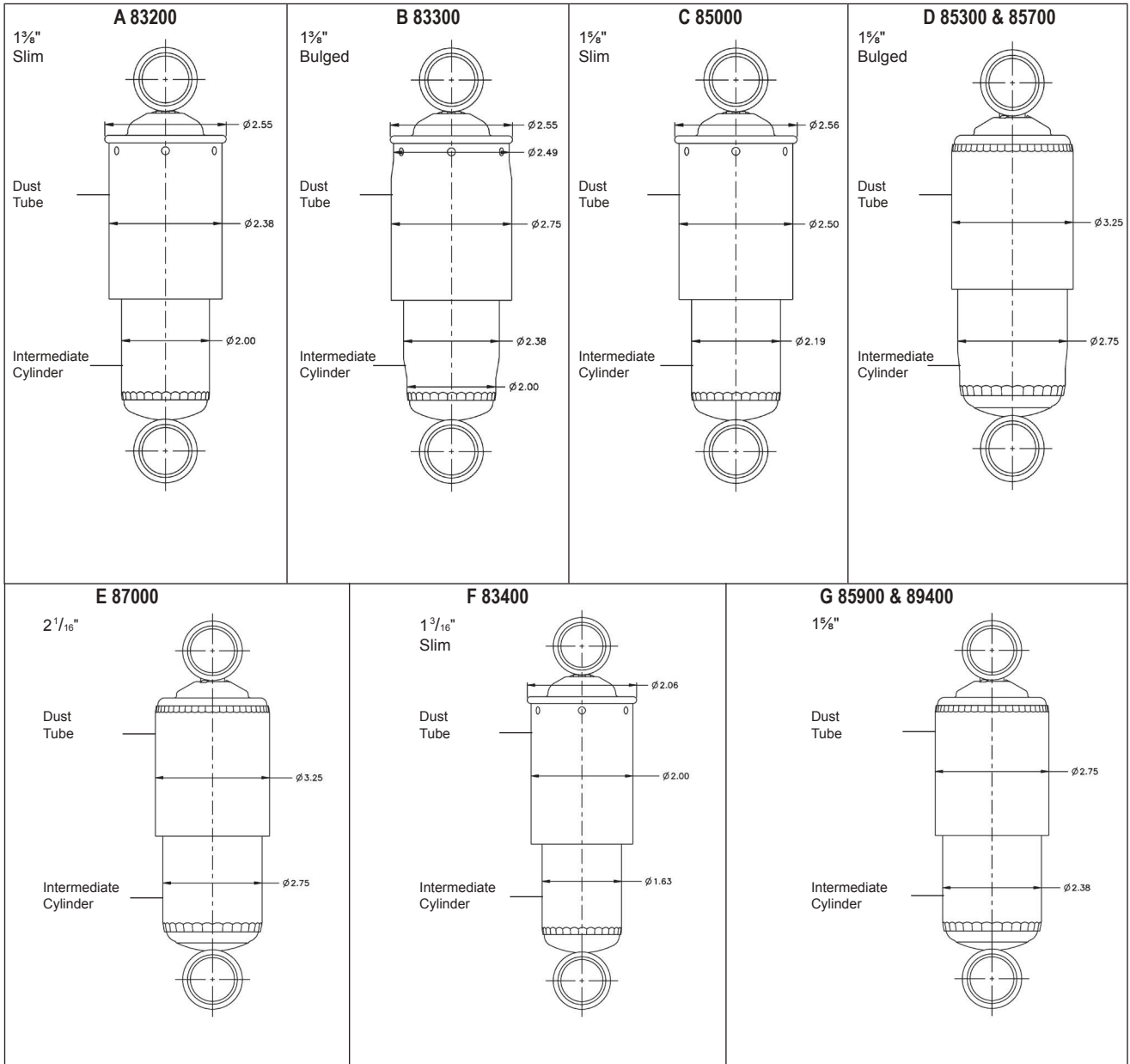

MOUNTING CODE "EB" EYE RING AND BUSHING

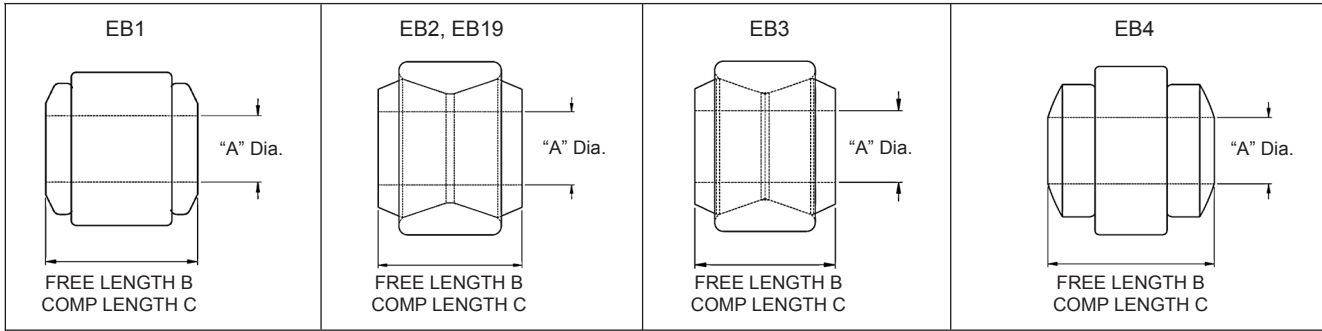

MOUNTING CODE	A DIAMETER	B FREE LENGTH	C COMP. LENGTH	VEHICLE MOUNTING PIN DIAMETER
EB1	5/8	1.44	1.31	5/8
EB2	3/4	1.75	1.50	3/4
EB3	1.00	1.91	1.75	1.00
EB4	11/16	1.72	1.55	11/16
EB18	19MM	1.65	--	19MM
EB19	20MM	1.75	1.25	20MM

"DS" & "S" STUD MOUNTS

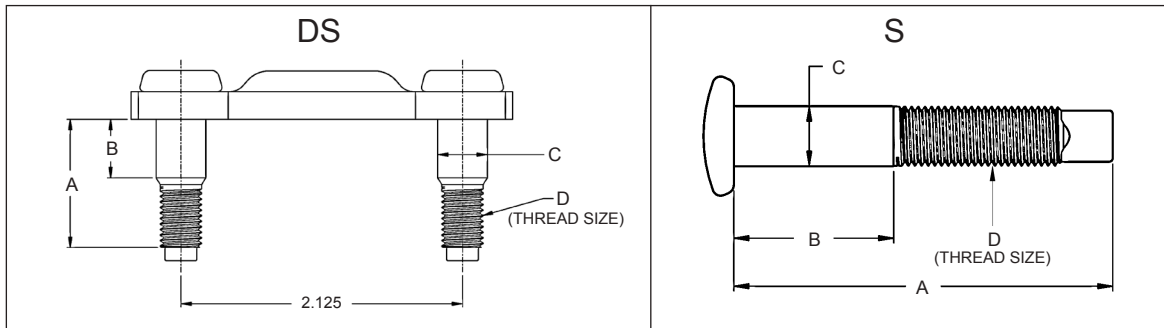

MOUNTING CODE	DIMENSION						
	A		B		C		D
	(inches)	(mm)	(inches)	(mm)	(inches)	(mm)	(thread)
DS1	1.27		.66		0.38		5/16-24
S1	2.37	60.20	1.00	25.40	0.38	9.53	3/8-24
S11	3.00	76.20	1.12	28.45	0.38	9.53	3/8-24
S12	2.37	60.20	1.15	29.21	0.44	11.11	3/8-24
S16	2.95	74.93	1.45	36.83	0.63	16.00	M16x1.5
S21	3.28	83.31	1.75	44.45	0.63	15.88	5/8-18
S29	2.99	75.95	1.87	47.50	0.38	9.53	3/8-24
S36	2.49	63.25	1.33	33.78	0.44	11.11	3/8-24
S38	2.75	69.85	1.70	43.18	0.55	14.00	M12x1.25
S40	2.52	64.01	1.33	33.78	0.44	11.11	3/8-24
S42	3.50	88.90	2.00	50.80	0.63	15.88	5/8-18
S43	2.75	69.85	1.25	31.75	0.63	15.88	5/8-18
S47	2.20	55.88	1.31	33.27	0.39	10.00	M10x1.25
S61	3.11	78.99	1.45	36.83	0.55	14.00	M12x1.25
S62	3.24	82.30	1.70	43.18	0.56	14.29	M12x1.25
S68	2.95	74.93	1.45	36.83	0.63	15.88	M16x1.5
S92	1.42	36.07	0.63	16.00	0.41	10.41	M12x1.25

MOUNTING CODE "BP" EYE RING AND BUSHING WITH BAR PIN

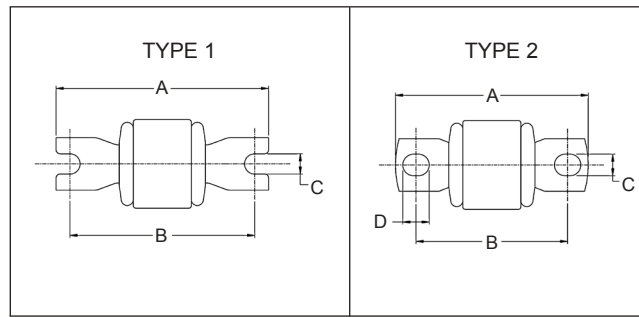

MOUNTING CODE	TYPE	DIMENSION									
		A		B		C		D		E	
		(inches)	(mm)	(inches)	(mm)	(inches)	(mm)	(inches)	(mm)	(inches)	(mm)
BP4	1	3.19	81.03	2.38	60.45	0.33	8.38	--	--	--	--
BP6	1	4.25	107.95	3.62	91.95	0.33	8.38	--	--	--	--
BP7	2	3.13	79.50	2.50	63.50	0.35	8.89	0.42	10.67	--	--
BP8	2	3.50	88.90	2.87	72.90	0.35	8.89	0.42	10.67	--	--
BP9	1	3.38	85.85	2.6	66.04	0.35	8.89	0.42	10.67	--	--
BP11	1	2.96	75.18	2.52	64.01	0.33	8.38	--	--	--	--
BP13	1	3.45	87.63	3.00	76.20	0.33	8.38	--	--	--	--
BP14	2	3.43	87.12	2.87	72.90	0.45	11.43	--	--	--	--
BP27	2	4.00	101.60	2.95	74.93	0.52	13.21	0.50	12.70	--	--
BP38	2	3.22	81.79	1.54	39.12	0.40	10.16	0.40	10.16	--	--

MOUNTING CODE "ES" EYE RING AND BUSHING WITH STEEL SLEEVE

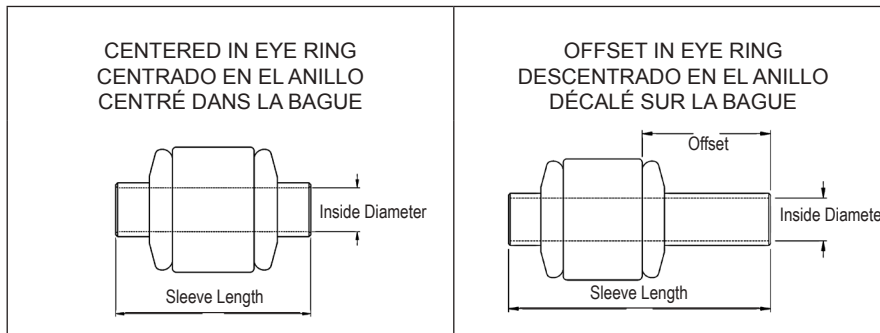

MOUNTING CODE	DIMENSION			
	Inside Diameter		Sleeve Length	
	(inches)	(mm)	(inches)	(mm)
ES3	0.39	10.00	1.56	39.62
ES7	0.56	14.29	1.25	31.75
ES10	0.44	11.11	1.38	35.05
ES13	0.56	14.29	1.89	48.01
ES19	0.47	12.00	1.88	47.75
ES24	0.50	12.70	1.38	35.05
ES25	0.50	12.70	1.50	38.10
ES26	0.50	12.70	1.56	39.62
ES27	0.50	12.70	1.62	41.15
ES31*	0.50	12.70	2.25	57.15
ES34	0.56	14.29	1.66	42.16
ES35	0.63	15.88	1.38	35.05
ES36	0.75	19.05	1.75	44.45
ES38	0.44	11.17	2.18	55.37
ES41	0.47	12.00	3.48	88.39
ES45	0.51	13.00	1.68	42.67
ES48	0.55	13.97	1.42	36.07

MOUNTING CODE	DIMENSION			
	Inside Diameter		Sleeve Length	
	(inches)	(mm)	(inches)	(mm)
ES48	0.55	13.97	1.66	42.16
ES56	0.55	14.00	1.58	40.13
ES60	0.55	14.00	1.26	32.00
ES64	0.63	16.00	1.25	31.75
ES65	0.47	12.00	1.38	35.05
ES77	0.79	20.07	1.48	37.59
ES83	0.47	12.00	1.48	37.59
ES87	0.48	12.30	1.65	41.91
ES90	0.63	15.88	2.00	50.80
ES120	0.75	19.05	2.76	70.10
ES126	0.50	12.70	2.44	61.98
ES128	0.50	12.70	1.66	42.16
ES136	0.63	15.88	1.75	44.45
ES141	0.47	12.00	1.61	40.89
ES149	0.50	12.70	2.36	59.94
ES150	0.75	19.05	2.24	56.90
ES153	0.55	14.00	1.55	39.37

* 1" / 25.4mm Offset

** 1.03" / 26.2 mm Offset

MOUNTING CODE "ES" EYE RING AND BUSHING WITH STEEL SLEEVE (CONTINUED)

MOUNTING CODE	DIMENSION			
	Inside Diameter		Sleeve Length	
	(inches)	(mm)	(inches)	(mm)
ES158	0.75	19.05	3.80	96.52
ES159**	0.75	19.05	3.21	81.53
ES160	1.00	25.40	2.01	51.05
ES161	0.63	16.00	3.95	100.33
ES162	0.63	16.00	2.60	66.04
ES163	0.44	11.11	2.50	63.50
ES164	0.50	12.70	2.26	57.40
ES165	0.50	12.70	1.75	44.45
ES171	0.50	12.70	1.88	47.75
ES172	0.50	12.70	2.72	69.09
ES174	0.63	15.88	3.25	82.55
ES175	0.63	16.00	1.96	49.78
ES176	0.63	16.00	3.72	94.49

MOUNTING CODE	DIMENSION			
	Inside Diameter		Sleeve Length	
	(inches)	(mm)	(inches)	(mm)
ES177	0.63	16.00	3.55	90.17
ES178	0.75	19.05	1.96	49.78
ES179	0.79	20.00	1.75	44.45
ES183	0.79	20.00	3.80	96.52
ES184	0.79	20.00	1.75	44.45
ES185	0.47	12.00	2.44	61.98
ES190	0.87	22.00	1.75	44.45
ES194	0.88	22.23	2.28	57.91
ES204	0.57	14.50	1.68	42.67
ES210	0.73	18.50	1.87	47.50
ES216	0.57	14.50	3.15	80.00

MOUNTING CODE "CL" CLEVIS

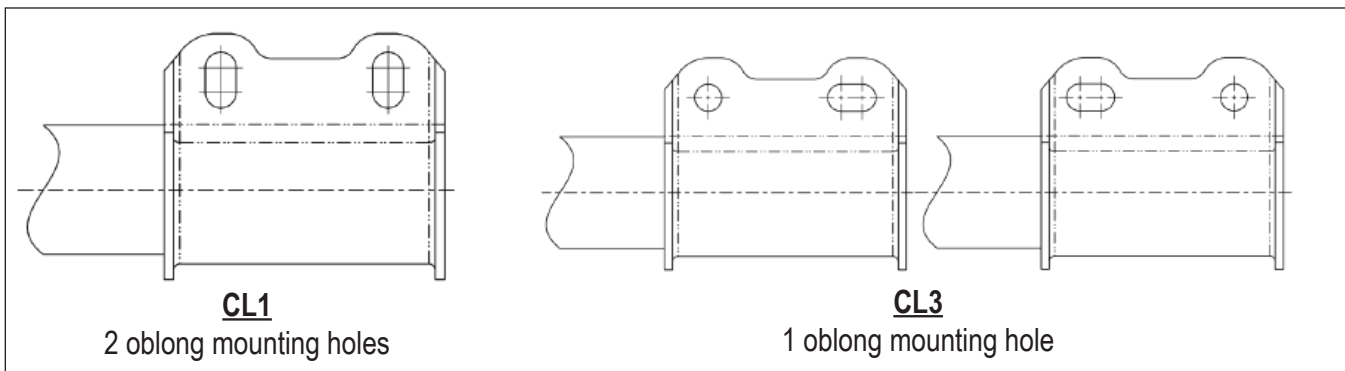

MOUNTING CODE "LP" PINCH SOCKET

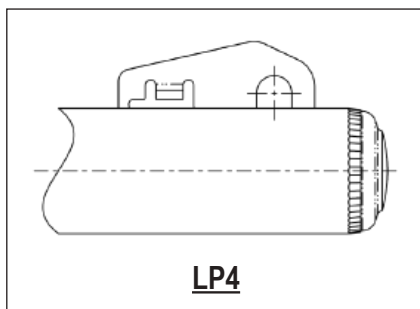

MOUNTING CODE "LU" U JOINT

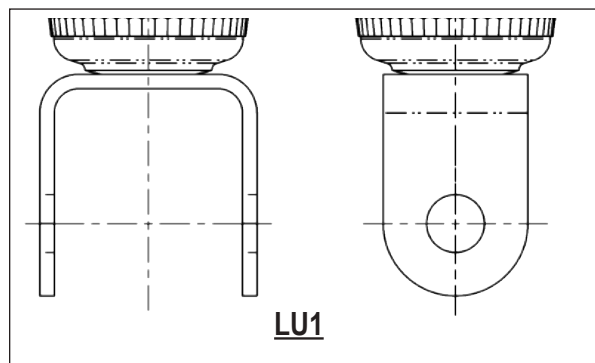

MOUNTING CODE “TM” TOP MOUNT

TM###

1st & 2nd digit - “Top Mount”

3rd digit - Part type/shape from the five categories listed below

4th digit - Number of studs / bolts (the amount of mounting points to the vehicle (see example below)

5th digit - Design of the mounting point - Stud (S) Bolt (B) Clip (C) (see example below)

TOP MOUNT DESIGN SHAPES



EXAMPLES

The fourth digit will note how many mounting points to the vehicle body exist.
The final digits indicate the type of mounting point **Stud (S)** **Bolt (B)** **Clip (C)**
(a combination is used for multiple mounting points)

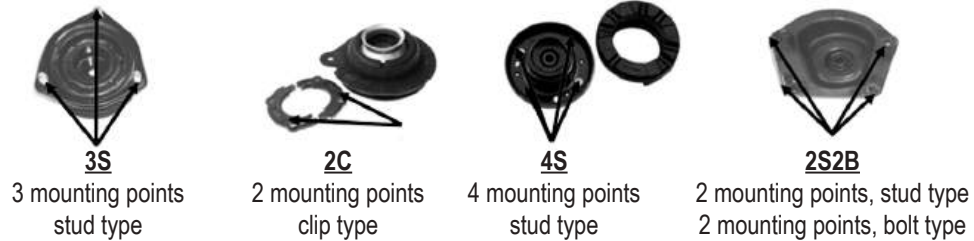

TOP MOUNT CODE	TOP MOUNT DESIGN	MOUNTING TYPE
TMR4S	Rectangle	4 Stud
TMT3S	Triangle	3 Stud
TMU2B	Unique	2 bolt
TMU2B1S	Unique	2 Bolt, 1 Stud

**SPECIFICATIONS BY END MOUNT
ESPECIFICACIONES POR TIPO DE MONTAJE
SPÉCIFICATIONS PAR FIXATION DES EXTRÉMITÉS**

Gabriel	Mounting		Lengths			Dust Tube	Recoil Cutoff	Controls*	
	Upper	Lower	Extended	Collapsed	Stroke			Rebound	Compression
G63897	BP14	ES34	23.87	14.68	9.19				
G63896	BP14	ES34	22.36	13.92	8.44				
G63638	BP14	ES34	24.33	14.8	9.53				
G63488	BP14	ES34	26.61	16.33	10.28				
81667	BP14	ES34	26.95	16.19	10.76				
77638	BP14	ES34	24.31	14.78	9.53				
77488	BP14	ES34	26.77	16.26	10.51				
61687	BP14	ES34	23.87	14.68	9.19				
61565	BP14	ES34	24.26	14.73	9.53				
61543	BP14	ES34	26.76	16.23	10.53				
58638	BP14	ES34	23.87	14.49	9.38				
58488	BP14	ES34	26.69	16.02	10.63				
49231	BP14	ES34	24.27	14.79	9.48				
49218	BP14	ES34	26.34	16.36	9.98				
43163	BP14	ES34	25.05	15.69	9.36				
NM1015	BP14	ES34	23.87	14.68	9.19				
NM1025	BP14	ES34	22.36	13.92	8.44				
G63837	BP14	ES83	28.23	17.95	10.28				
G63607	BP14	ES83	25.58	15.3	10.28				
77837	BP14	ES83	28.73	16.92	11.81				
77607	BP14	ES83	25.39	15.18	10.21				
82012	BP6	ES25	16.04	10.53	5.51				
43180	BP8	ES34	23.55	14.19	9.36				
G63907	EB1	EB1	20.23	12.37	7.86				
G63692	EB1	EB1	27.58	16.3	11.28				
G63492	EB1	EB1	22.58	13.8	8.78				
G63419	EB1	EB1	24.08	14.55	9.53				
G63405	EB1	EB1	20.01	12.48	7.53				
G63299	EB1	EB1	18.08	11.55	6.53				
6855SE	EB1	EB1	23.83	14.3	9.53				
6854SE	EB1	EB1	23.03	14.27	8.76				
6828SE	EB1	EB1	21.23	12.87	8.36				
6804SE	EB1	EB1	24.08	14.67	9.41				
82156	EB1	EB1	20.23	12.37	7.86				
82047	EB1	EB1	20.23	12.37	7.86				
82007	EB1	EB1	18.23	11.37	6.86				
81676	EB1	EB1	17.73	11.12	6.61				

* Damping force, in pounds, to either extend or collapse the shock absorber at an average operating velocity. Fuerza de amortiguación en libras para extender o comprimir el amortiguador a una velocidad de operación promedio. La puissance d'amortissement en poids de l'amortisseur, soit comprimé, soit détendu, à une vitesse de fonctionnement moyenne.

**SPECIFICATIONS BY END MOUNT
ESPECIFICACIONES POR TIPO DE MONTAJE
SPÉCIFICATIONS PAR FIXATION DES EXTRÉMITÉS**

Gabriel	Mounting		Lengths			Dust Tube	Recoil Cutoff	Controls*	
	Upper	Lower	Extended	Collapsed	Stroke			Rebound	Compression
81318	EB1	EB1	22.73	13.87	8.86				
81147	EB1	EB1	20.23	12.37	7.86				
77907	EB1	EB1	19.87	12.23	7.64				
61506	EB1	EB1	21.86	13.58	8.28				
61500	EB1	EB1	20.23	12.37	7.86				
49311	EB1	EB1	22.44	14	8.44				
49310	EB1	EB1	20.35	12.75	7.60				
43048	EB1	EB1	20.45	12.62	7.83				
14017	EB1	EB1	24.04	14.43	9.61				
G63625	EB1	ES24	22.56	13.78	8.78				
G63394	EB1	ES24	16.01	10.48	5.53				
G63355	EB1	ES24	14.98	9.95	5.03				
6853SE	EB1	ES24	19.33	12.05	7.28				
81039	EB1	ES24	14.73	9.62	5.11				
61525	EB1	ES24	15.01	9.95	5.06				
34036	EB1	ES24	14.16	9.53	4.63				
G63377	EB1	ES25	20.08	12.55	7.53				
82147	EB1	ES25	23.23	13.87	9.36				
81484	EB1	ES25	20.23	12.37	7.86				
61519	EB1	ES25	19.98	12.45	7.53				
49127	EB1	ES25	19.87	12.63	7.24				
43058	EB1	ES25	19.95	12.37	7.58				
G63349	EB1	ES34	23.33	14.3	9.03				
81164	EB1	ES34	23.23	13.87	9.36				
61524	EB1	ES34	23.26	14.23	9.03				
49155	EB1	ES34	23.27	14.29	8.98				
77987	EB1	ES48	27.24	16.38	10.86				
77986	EB1	ES48	31.01	18.65	12.36				
G64269	EB1	ES56	26.93	16.04	10.89				
G64268	EB1	ES56	31.34	18.70	12.64				
77988	EB1	ES56	30.12	17.97	12.14				
6847SE	EB1	ES65	23	13.83	9.17				
NM1028	EB1	ES56	31.34	18.70	12.64				
NM1029	EB1	ES56	26.93	16.04	10.89				
G64010	EB1	ES83	26.94	16	10.94				
G63888	EB1	ES83	31.36	18.67	12.69				
G63809	EB1	ES83	22.98	13.95	9.03				

* Damping force, in pounds, to either extend or collapse the shock absorber at an average operating velocity. Fuerza de amortiguación en libras para extender o comprimir el amortiguador a una velocidad de operación promedio. La puissance d'amortissement en poids de l'amortisseur, soit comprimé, soit détendu, à une vitesse de fonctionnement moyenne.

**SPECIFICATIONS BY END MOUNT
ESPECIFICACIONES POR TIPO DE MONTAJE
SPÉCIFICATIONS PAR FIXATION DES EXTRÉMITÉS**

Gabriel	Mounting		Lengths			Dust Tube	Recoil Cutoff	Controls*	
	Upper	Lower	Extended	Collapsed	Stroke			Rebound	Compression
G63808	EB1	ES83	28.86	17.08	11.78				
G63461	EB1	ES83	25.51	15.23	10.28				
G63456	EB1	ES83	26.85	16.07	10.78				
81510	EB1	ES83	25.73	15.12	10.61				
81082	EB1	ES83	23.23	13.87	9.36				
77969	EB1	ES83	25.43	15.81	9.62				
77968	EB1	ES83	24.71	15.09	9.62				
77952	EB1	ES83	29.68	17.43	12.25				
77810	EB1	ES83	31.53	18.5	13.03				
77809	EB1	ES83	22.92	13.9	9.02				
77808	EB1	ES83	28.73	16.92	11.81				
77461	EB1	ES83	25.39	15.18	10.21				
61713	EB1	ES83	26.94	16	10.94				
61682	EB1	ES83	31.36	18.67	12.69				
61654	EB1	ES83	28.76	16.98	11.78				
61554	EB1	ES83	21.48	13.2	8.28				
61547	EB1	ES83	23.01	14.07	8.94				
61530	EB1	ES83	25.48	15.2	10.28				
58810	EB1	ES83	31.42	18.42	13.00				
58809	EB1	ES83	23.65	14.53	9.12				
58808	EB1	ES83	28.38	16.75	11.63				
43167	EB1	ES83	22.99	13.88	9.11				
NM1014	EB1	ES83	31.36	18.67	12.69				
G63604	EB1	ES142	19.74	12.46	7.28				
G63810	EB1	ES185	31.6	18.57	13.03				
G63409	EB1	ES185	21.48	13.2	8.28				
81710	EB1	ES185	21.73	13.12	8.61				
6850SE	EB1	S1	23.3	13.77	9.53				
89413	EB2	EB2	20.94	13.53	7.41	YES	NO	536‡	201
89409	EB2	EB2	27.13	16.92	10.2	YES	YES	567‡	165
85012	EB2	EB2	21.02	13.23	7.79	YES	NO	523	199
83519	EB2	EB2	23.83	14.35	9.48	YES	NO	292	132
83312	EB2	EB2	26.64	16.11	10.53	YES	YES	527	152
83308	EB2	EB2	25.14	15.36	9.78	YES	YES	445	180
83216	EB2	EB2	23.51	14.48	9.03	YES	YES	776	262
83159	EB2	EB2	21.85	13.56	8.29	YES	NO	658	149
83309	EB2	EB2	28.64	17.11	11.53				

* Damping force, in pounds, to either extend or collapse the shock absorber at an average operating velocity. Fuerza de amortiguación en libras para extender o comprimir el amortiguador a una velocidad de operación promedio. La puissance d'amortissement en poids de l'amortisseur, soit comprimé, soit détendu, à une vitesse de fonctionnement moyenne.

**SPECIFICATIONS BY END MOUNT
ESPECIFICACIONES POR TIPO DE MONTAJE
SPÉCIFICATIONS PAR FIXATION DES EXTRÉMITÉS**

Gabriel	Mounting		Lengths			Dust Tube	Recoil Cutoff	Controls*	
	Upper	Lower	Extended	Collapsed	Stroke			Rebound	Compression
83314	EB2	EB2	30.64	18.11	12.53				
85300	EB3	EB3	17.98	12.21	5.78				
85304	EB3	EB3	22.25	14.22	8.03				
85307	EB3	EB3	23.98	15.08	8.89				
85329	EB3	EB3	24.52	15.48	9.04				
85716	EB3	EB3	21.99	14.33	7.66				
85736	EB3	EB3	23.61	15.2	8.41				
89419	EB3	EB3	18.04	12.67	5.36				
89425	EB3	EB3	26.5	16.93	9.57				
89410	EB3	EB3	26.34	16.57	9.77	YES	NO	1185‡	182
85734	EB3	EB3	20.73	13.7	7.03	YES	YES	1288	227
85712	EB3	EB3	20.5	13.47	7.04	YES	YES	1435	562
85007	EB3	EB3	24.33	15.4	8.93	YES	YES	1008	171
85001	EB3	EB3	26.3	16.39	9.92	YES	NO	1202	186
83225	EB3	EB3	24.14	15.11	9.03	YES	YES	482	159
83215	EB3	EB3	26.64	16.36	10.28	YES	YES	697	108
83141	EB3	EB3	25.27	15.52	9.75	YES	NO	408	113
83140	EB3	EB3	25.28	15.53	9.75	YES	NO	738	88
85723	EB3	S21	19.93	12.9	7.03	YES	YES	1318	248
G63183	EB4	EB4	20.79	13.01	7.78				
82065	EB4	EB4	19.04	11.93	7.11				
81825	EB4	EB4	21.1	12.99	8.11				
61632	EB4	EB4	20.79	13.01	7.78				
43085	EB4	ES27	20.61	12.78	n/a				
83119	EB4	ES165	23.96	14.84	9.12				
83303	EB7	ES36	24.86	15.08	9.78				
43111	EB7	ES34	22.9	13.82	9.08				
G63605	EB19	ES27	24.24	14.71	9.53				
83021	ES10	ES10	9.41	7.4	2.01	YES	YES	745	315
83154	ES120	S21	20.78	12.72	8.06	YES	YES	599	140
83120	ES120	S21	22.17	13.66	8.51	YES	YES	779	164
G64246	ES123	ES123	20.14	12.73	7.41				
G63609	ES126	ES128	16.5	10.97	5.53				
81726	ES126	ES128	16.48	10.87	5.61				
77609	ES126	ES128	16.43	10.95	5.48				
61542	ES126	ES128	16.73	10.95	5.78				
58609	ES126	ES45	16.49	11.05	5.44				

* Damping force, in pounds, to either extend or collapse the shock absorber at an average operating velocity. Fuerza de amortiguación en libras para extender o comprimir el amortiguador a una velocidad de operación promedio. La puissance d'amortissement en poids de l'amortisseur, soit comprimé, doit détendu, à une vitesse de fonctionnement moyenne.

SPECIFICATIONS BY END MOUNT
ESPECIFICACIONES POR TIPO DE MONTAJE
SPÉCIFICATIONS PAR FIXATION DES EXTRÉMITÉS

Gabriel	Mounting		Lengths			Dust Tube	Recoil Cutoff	Controls*	
	Upper	Lower	Extended	Collapsed	Stroke			Rebound	Compression
83160	ES128	ES36	24.31	14.9	9.37	YES	YES	920	161
85650	ES136	ES34	24.88	16.35	8.53	YES	NO	941	463
83006	ES149	EB1	10.71	8.52	2.78	YES	YES	525	182
83039	ES149	ES149	10.44	8.4	3				
85180	ES150	ES36	20.94	13.83	7.11				
89503	ES150	ES150	21.28	13.72	7.56	YES	NO	1033‡	123
89449	ES150	ES150	23.25	14.9	8.35	YES	NO	1519‡	324
85959	ES150	ES150	21.16	13.57	7.59	YES	YES	1021	123
85958	ES150	ES150	22.89	14.5	8.39	YES	YES	1926	281
85920	ES150	ES150	21.16	13.57	7.59	YES	NO	845	49
85918	ES150	ES150	22.97	14.58	8.39	YES	NO	1726	412
85106	ES150	ES150	20.03	12.89	7.14	YES	YES	1054	109
85181	ES150	ES150	26.33	17.06	9.27				
83066	ES153	ES153	11.15	9.2	2.78	YES	YES	599	221
89443	ES158	ES159	22.19	14.66	7.53	YES	YES	1206‡	466
85724	ES158	ES159	22.81	14.51	8.3	YES	YES	1235	454
85335	ES158	ES159	19.62	12.85	6.77	YES	YES	827	107
85331	ES158	ES159	19.62	12.85	6.77	YES	YES	1757	396
85125	ES158	ES159	26.9	16.64	10.26	YES	YES	1479	183
85188	ES161	ES162	25.31	15.52	9.79	YES	YES	1074	255
83143	ES162	S42	21.92	13.51	8.41	YES	YES	403	137
83142	ES162	S42	23.92	14.49	9.43	YES	YES	367	131
83025	ES163	ES163	8.02	6.53	1.48	YES	YES	710	230
83040	ES171	ES172	10.44	8.4	3	YES	YES	876	326
89460	ES174	ES136	20.58	13.03	7.55	YES	NO	997‡	384
85989	ES174	ES136	20.78	13.15	7.63	YES	NO	1812	351
85084	ES174	ES136	20.59	13.03	7.57	YES	NO	1145	407
85670	ES175	ES175	23.19	14.67	8.52	YES	YES	591	176
83398	ES175	ES175	23.23	15.38	7.85	YES	YES	293	168
83397	ES175	ES175	18.67	11.91	6.76	YES	NO	303	101
83243	ES175	ES175	24.41	15.26	9.15	YES	YES	296	170
83163	ES175	ES175	20.75	13.01	7.74	YES	NO	828	98
83175	ES175	ES175	20.48	13.19	7.29				
85031	ES176	EB2	25.63	15.87	9.76	YES	NO	941	257
85642	ES177	ES90	22.52	14.52	8	YES	YES	1920	309
89458	ES177	ES161	22.48	14.6	7.88	YES	YES	1575‡	222
85923	ES177	ES161	22.52	14.52	8	YES	YES	1940	221

* Damping force, in pounds, to either extend or collapse the shock absorber at an average operating velocity. Fuerza de amortiguación en libras para extender o comprimir el amortiguador a una velocidad de operación promedio. La puissance d'amortissement en poids de l'amortisseur, soit comprimé, soit détendu, à une vitesse de fonctionnement moyenne.

**SPECIFICATIONS BY END MOUNT
ESPECIFICACIONES POR TIPO DE MONTAJE
SPÉCIFICATIONS PAR FIXATION DES EXTRÉMITÉS**

Gabriel	Mounting		Lengths			Dust Tube	Recoil Cutoff	Controls*	
	Upper	Lower	Extended	Collapsed	Stroke			Rebound	Compression
89453	ES178	ES150	21.14	13.93	7.21	YES	YES	860‡	435
85932	ES178	ES150	21.26	13.7	7.56	YES	YES	1102	430
83166	ES179	ES179	25.28	15.78	9.49	YES	YES	622	132
83147	ES179	ES179	28.54	17.4	11.15				
83148	ES179	ES179	30	17.83	12.17				
83168	ES179	ES179	25.28	15.78	9.49				
85978	ES179	ES179	29.84	18.16	11.69				
G64042	ES18	ES18	14.92	10.55	4.37				
85956	ES183	ES184	30.65	18.77	11.88	YES	YES	979	373
83054	ES185	ES185	10.28	7.56	2.72	YES	YES	1004	184
61656	ES185	ES185	31.51	18.48	13.03				
61655	ES185	ES185	23.01	14.07	8.94				
83391	ES190	ES190	25.52	15.61	9.91	YES	NO	590	105
G64164	ES210	ES13	19.95	12.81	7.14				
G64177	ES216	ES19	25.86	16.1	9.76				
82035	ES24	EB1	14.64	9.53	5.11				
G63357	ES24	ES24	14.98	9.95	5.03				
G63306	ES24	ES24	19.85	12.57	7.28				
82003	ES24	ES24	18.55	11.44	7.11				
61517	ES24	ES24	14.98	9.95	5.03				
58357	ES24	ES24	14.68	10.06	4.62				
49162	ES24	ES24	20.02	12.79	7.23				
49107	ES24	ES24	19.27	12.29	6.98				
G63671	ES26	ES26	22.48	13.7	8.78				
G63403	ES26	ES26	24.58	14.8	9.78				
77403	ES26	ES26	24.31	14.78	9.53				
58403	ES26	ES26	24.48	14.95	9.53				
G63353	ES27	EB4	24.74	14.96	9.78				
81342	ES27	EB4	28.89	16.78	12.11				
81091	ES27	EB4	25.14	15.28	9.86				
49149	ES27	EB4	24.93	15.64	9.29				
G63413	ES27	ES27	20.76	12.98	7.78				
81496	ES27	ES27	20.49	12.63	7.86				
61522	ES27	ES27	20.49	12.63	7.86				
49212	ES27	ES27	21.02	13.29	7.73				
G63347	ES31	ES24	18.08	11.55	6.53				
81113	ES31	ES24	18.23	11.37	6.86				

* Damping force, in pounds, to either extend or collapse the shock absorber at an average operating velocity. Fuerza de amortiguación en libras para extender o comprimir el amortiguador a una velocidad de operación promedio. La puissance d'amortissement en poids de l'amortisseur, soit comprimé, soit détendu, à une vitesse de fonctionnement moyenne.

**SPECIFICATIONS BY END MOUNT
ESPECIFICACIONES POR TIPO DE MONTAJE
SPÉCIFICATIONS PAR FIXATION DES EXTRÉMITÉS**

Gabriel	Mounting		Lengths			Dust Tube	Recoil Cutoff	Controls*	
	Upper	Lower	Extended	Collapsed	Stroke			Rebound	Compression
61516	ES31	ES24	18.23	11.37	6.86				
G63411	ES31	ES26	18.58	11.8	6.78				
G64121	ES34	ES34	25.35	16.17	9.18				
G64013	ES34	ES34	26.52	16.33	10.19				
G63971	ES34	ES34	27.58	17.14	10.44				
G63675	ES34	ES34	26.86	16.08	10.78				
G63662	ES34	ES34	24.58	15.05	9.53				
G63366	ES34	ES34	23.26	14.23	9.03				
81921	ES34	ES34	26.76	15.67	11.09				
81873	ES34	ES34	24.74	14.88	9.86				
77976	ES34	ES34	24.84	16.07	8.76				
77950	ES34	ES34	27.5	17.5	10.00				
77675	ES34	ES34	26.25	15.74	10.51				
77662	ES34	ES34	24.31	14.78	9.53				
77412	ES34	ES34	26.77	16.26	10.51				
61716	ES34	ES34	26.5	16.33	10.17				
61710	ES34	ES34	27.58	17.14	10.44				
61642	ES34	ES34	26.76	15.98	10.78				
61600	ES34	ES34	24.51	14.98	9.53				
58930	ES34	ES34	22.81	14.06	8.75				
58662	ES34	ES34	24.68	15.36	9.32				
58412	ES34	ES34	26.68	16.18	10.50				
49235	ES34	ES34	24.77	15.04	9.73				
43181	ES34	ES34	24.24	14.88	9.36				
G63866	ES34	ES34	22.81	14.12	8.69				
NM1001	ES34	ES34	26.86	16.08	10.78				
NM1004	ES34	ES34	24.58	15.05	9.53				
NM1024	ES34	ES34	26.52	16.33	10.19				
G63918	ES34	ES141	21.25	13.56	7.69				
82086	ES35	ES35	25.54	14.93	10.61				
89431	ES36	ES36	22.41	14.16	8.25	YES	NO	751‡	211
89430	ES36	ES36	24.61	15.66	8.94	YES	YES	1462‡	279
89414	ES36	ES36	29.65	18.18	11.46	YES	YES	1045‡	217
89407	ES36	ES36	21.61	14.17	7.45	YES	YES	652‡	218
89406	ES36	ES36	24.76	15.82	8.93	YES	YES	658‡	125
89405	ES36	ES36	26.3	16.57	9.73	YES	YES	1009‡	249
85976	ES36	ES36	29.92	18.12	11.8	YES	YES	582	138
85919	ES36	ES36	22.52	14.33	8.19	YES	YES	1265	121

* Damping force, in pounds, to either extend or collapse the shock absorber at an average operating velocity. Fuerza de amortiguación en libras para extender o comprimir el amortiguador a una velocidad de operación promedio. La puissance d'amortissement en poids de l'amortisseur, soit comprimé, soit détendu, à une vitesse de fonctionnement moyenne.

**SPECIFICATIONS BY END MOUNT
ESPECIFICACIONES POR TIPO DE MONTAJE
SPÉCIFICATIONS PAR FIXATION DES EXTRÉMITÉS**

Gabriel	Mounting		Lengths			Dust Tube	Recoil Cutoff	Controls*	
	Upper	Lower	Extended	Collapsed	Stroke			Rebound	Compression
85058	ES36	ES36	22.67	14.26	8.41	YES	YES	722	114
85043	ES36	ES36	27.63	16.85	10.78	YES	YES	628	163
85029	ES36	ES36	20.54	13.11	7.43	YES	YES	1019	219
85013	ES36	ES36	29.79	17.76	12.04	YES	YES	1019	219
85010	ES36	ES36	26.8	16.26	10.54	YES	YES	1019	219
85006	ES36	ES36	28.54	17.13	11.41	YES	YES	1019	219
85005	ES36	ES36	24.76	15.24	9.52	YES	YES	1019	219
83221	ES36	ES36	24.01	14.73	9.28	YES	YES	599	153
83209	ES36	ES36	29.64	17.61	12.03	YES	YES	670	78
83137	ES36	ES36	30.04	17.79	12.25	YES	YES	517	132
83127	ES36	ES36	20.16	13.14	7.01	YES	YES	940	218
83126	ES36	ES36	24.41	15.27	9.14	YES	YES	625	115
83124	ES36	ES36	21.65	13.77	7.88	YES	YES	750	137
83123	ES36	ES36	26.65	16.41	10.24	YES	YES	589	119
83122	ES36	ES36	25.28	15.79	9.49	YES	YES	661	201
83144	ES36	ES36	23.78	15.03	8.74				
83203	ES36	ES36	17.1	11.36	5.74				
83207	ES36	ES36	21.64	13.61	8.03				
85000	ES36	ES36	17.28	11.5	5.78				
85014	ES36	ES36	21.76	13.74	8.02				
85036	ES36	ES36	26.38	16.29	10.09				
85909	ES36	ES36	24.25	15.19	9.06				
85910	ES36	ES36	20.79	13.54	7.25				
85979	ES36	ES36	31.18	18.66	12.52				
89436	ES36	ES36	17.24	12.04	5.2				
646218	ES36	ES36	22.49	14.11	8.38				
83157	ES36	ES90	26.38	15.76	10.61	YES	NO	446	303
83164	ES36	ES165	24.22	14.59	9.63	YES	NO	426	274
85072	ES36	ES176	24.17	14.81	9.36	YES	YES	1387	305
83112	ES36	S42	21.52	13.41	8.11				
61614	ES41	ES41	22.98	13.95	9.03				
G64089	ES56	ES56	20.43	13.03	7.4				
14072	ES83	EB18	28.22	16.49	11.73				
G63455	ES83	ES83	22.98	13.95	9.03				
81821	ES83	ES83	23.23	13.87	9.36				
77455	ES83	ES83	22.92	13.9	9.02				
83131	ES83	ES83	27.8	18.18	9.62				

* Damping force, in pounds, to either extend or collapse the shock absorber at an average operating velocity. Fuerza de amortiguación en libras para extender o comprimir el amortiguador a una velocidad de operación promedio. La puissance d'amortissement en poids de l'amortisseur, soit comprimé, soit détendu, à une vitesse de fonctionnement moyenne.

SPECIFICATIONS BY END MOUNT
ESPECIFICACIONES POR TIPO DE MONTAJE
SPÉCIFICATIONS PAR FIXATION DES EXTRÉMITÉS

Gabriel	Mounting		Lengths			Dust Tube	Recoil Cutoff	Controls*	
	Upper	Lower	Extended	Collapsed	Stroke			Rebound	Compression
85995	ES90	ES36	23.5	14.52	8.98				
83364	ES90	ES83	24.06	15.07	8.99	YES	YES	855	206
83180	ES90	ES83	30.2	21.24	8.96	YES	NO	909	204
85957	ES90	ES90	20.78	13.19	7.6	YES	NO	1583	138
85928	ES90	ES90	20.31	13.24	7.07	YES	NO	957	229
85656	ES90	ES90	26.49	16.94	10.75	YES	YES	1225	274
85082	ES90	ES90	28.6	20.64	7.97	YES	YES	1435	266
83169	ES90	ES90	18.55	11.91	6.64	YES	NO	599	171
83135	ES90	ES90	19.49	12.38	7.11	YES	NO	519	121
83101	ES90	ES90	24.63	15.13	9.49	YES	YES	481	142
85003	ES90	ES90	25.42	15.63	9.79				
85927	ES90	ES90	24.76	15.47	9.3				
G64148	LU1	DS1	18.39	14.09	4.3				
61529	S1	BP4	14.1	9.34	4.76				
G63950	S1	BP7	14.2	9.09	5.11				
61556	S1	BP7	14.2	9.09	5.11				
34073	S1	BP7	14.29	9.37	4.92				
G63418	S1	BP11	13.95	9.17	4.78				
G63360	S1	BP13	15.7	9.92	5.78				
G63359	S1	BP13	13.7	8.92	4.78				
81834	S1	BP13	15.7	9.84	5.86				
81096	S1	BP13	13.7	8.84	4.86				
61523	S1	BP13	13.7	8.92	4.78				
58359	S1	BP13	13.92	9.14	4.78				
34052	S1	BP13	13.62	9	4.62				
6856SE	S1	EB1	27.3	15.77	11.53				
82155	S1	EB1	20.7	12.34	8.36				
82066	S1	EB1	22.7	13.34	9.36				
81495	S1	EB1	20.2	12.34	7.86				
81340	S1	EB1	20.7	12.34	8.36				
61546	S1	EB1	18.45	11.67	6.78				
49205	S1	EB1	21.12	13.13	7.99				
49203	S1	EB1	20.24	12.51	7.73				
43140	S1	EB1	20.92	12.84	8.08				
83518	S1	EB2	24.4	14.26	10.14	YES	NO	153	82
83515	S1	EB2	23.34	13.89	9.45	YES	NO	643	205
G63432	S1	EB19	21.11	12.83	8.28				

* Damping force, in pounds, to either extend or collapse the shock absorber at an average operating velocity. Fuerza de amortiguación en libras para extender o comprimir el amortiguador a una velocidad de operación promedio. La puissance d'amortissement en poids de l'amortisseur, soit comprimé, soit détendu, à une vitesse de fonctionnement moyenne.

**SPECIFICATIONS BY END MOUNT
ESPECIFICACIONES POR TIPO DE MONTAJE
SPÉCIFICATIONS PAR FIXATION DES EXTRÉMITÉS**

Gabriel	Mounting		Lengths			Dust Tube	Recoil Cutoff	Controls*	
	Upper	Lower	Extended	Collapsed	Stroke			Rebound	Compression
G63387	S1	ES25	23.32	14.04	9.28				
G63350	S1	ES25	18.82	11.79	7.03				
81242	S1	ES25	19.2	11.59	7.61				
61518	S1	ES25	18.73	11.7	7.03				
49178	S1	ES25	23.12	13.89	9.23				
49173	S1	ES25	19.24	12.01	7.23				
43099	S1	ES25	19.17	11.77	7.40				
6861SE	S1	S1	20.27	11.99	8.28				
6803SE	S1	S1	22.52	13.36	9.16				
6802SE	S1	S1	20.02	12.11	7.91				
82034	S1	S1	22.17	12.81	9.36				
82026	S1	S1	13.42	8.56	4.86				
81270	S1	S1	17.67	10.56	7.11				
G63895	S11	BP9	14.12	9.68	4.44				
G63894	S11	BP9	12.82	8.88	3.94				
61685	S11	BP9	14.12	9.68	4.44				
61684	S11	BP9	12.82	8.88	3.94				
NM1016	S11	BP9	14.12	9.68	4.44				
G63893	S11	LU1	15.07	10.44	4.63				
61683	S11	LU1	15.07	10.44	4.63				
NM1019	S11	LU1	15.07	10.44	4.63				
G63375	S12	BP7	14.14	9.11	5.03				
77375	S12	BP7	14.14	9.04	5.10				
61555	S12	BP7	14.14	9.11	5.03				
G63783	S12	BP11	14.59	10.21	4.38				
81920	S12	BP11	14.71	10.1	4.61				
77783	S12	BP11	14.64	10.12	4.52				
61641	S12	BP11	14.7	10.17	4.53				
NM1008	S12	BP11	14.59	10.21	4.38				
G63410	S12	EB1	18.55	11.77	6.78				
61521	S12	ES25	16.45	10.67	5.78				
34058	S12	ES3	17.13	11.01	n/a				
77661	S12	ES34	13.72	9.5	4.22				
85316	S21	ES36	20.61	12.82	7.8				
G63817	S12	ES60	15.8	11.02	4.78				
77817	S12	ES60	15.73	10.94	4.79				
61663	S12	ES60	15.7	10.92	4.78				

* Damping force, in pounds, to either extend or collapse the shock absorber at an average operating velocity. Fuerza de amortiguación en libras para extender o comprimir el amortiguador a una velocidad de operación promedio. La puissance d'amortissement en poids de l'amortisseur, soit comprimé, soit détendu, à une vitesse de fonctionnement moyenne.

**SPECIFICATIONS BY END MOUNT
ESPECIFICACIONES POR TIPO DE MONTAJE
SPÉCIFICATIONS PAR FIXATION DES EXTRÉMITÉS**

Gabriel	Mounting		Lengths			Dust Tube	Recoil Cutoff	Controls*	
	Upper	Lower	Extended	Collapsed	Stroke			Rebound	Compression
58817	S12	ES60	15.59	10.96	4.63				
NM1007	S12	ES60	15.8	11.02	4.78				
81925	S12	ES7	14.7	9.59	5.11				
81490	S12	ES83	14.85	9.84	5.01				
G63778	S12	ES171	24.55	14.52	10.03				
G63715	S12	ES171	28.55	16.52	12.03				
81913	S12	ES171	28.39	16.28	12.11				
81892	S12	ES171	24.2	14.09	10.11				
77715	S12	ES171	28.32	16.33	11.99				
61638	S12	ES171	24.45	14.42	10.03				
61612	S12	ES171	28.39	16.36	12.03				
49237	S12	ES171	24.18	14.45	9.73				
83317	S16	ES90	27.03	16	11.34	YES	YES		
83613	S16	S16	21.04	12.76	8.28	YES	YES	601	242
89424	S21	EB3	23.73	15.14	8.59	YES	YES	794‡	253
85988	S21	EB3	23.84	14.87	8.97	YES	YES	1200	138
85711	S21	EB3	24.54	15.26	9.27				
85311	S21	EB3	23.95	14.79	9.16	YES	YES	764	254
85921	S21	ES36	22.07	13.57	8.5	YES	NO	2053	339
85009	S21	ES36	23.56	14.4	9.16	YES	YES	857	144
83134	S21	ES36	22.27	13.51	8.77	YES	NO	430	49
83395	S21	ES178	27.19	16.28	10.91	YES	NO	616	105
89455	S21	S21	26.31	16.03	10.28	YES	YES	791‡	276
89447	S21	S21	23.63	14.69	8.94	YES	YES	702‡	241
89423	S21	S21	18.67	12.21	6.46	YES	YES	1352‡	573
85902	S21	S21	19.03	12.09	6.93	YES	YES	1441	267
85900	S21	S21	17.33	11.23	6.11	YES	YES	1467	337
85310	S21	S21	18.63	11.71	6.92	YES	YES	1379	578
85124	S21	S21	20.91	12.9	8.01	YES	YES	1086	222
85071	S21	S21	25.57	15.02	10.55	YES	NO	610	107
85069	S21	S21	26.31	15.97	10.33	YES	YES	762	255
83456	S21	S21	24.03	14.25	9.78	YES	YES	566	80
83136	S21	S21	29.31	16.8	12.51	YES	NO	914	65
83103	S21	S21	19.66	11.93	7.74	YES	YES	517	301
83102	S21	S21	22.89	13.54	9.35				
85705	S21	S21	23.62	14.23	9.39				
81713	S29	BP7	14.42	9.31	5.11				

* Damping force, in pounds, to either extend or collapse the shock absorber at an average operating velocity. Fuerza de amortiguación en libras para extender o comprimir el amortiguador a una velocidad de operación promedio. La puissance d'amortissement en poids de l'amortisseur, soit comprimé, soit détendu, à une vitesse de fonctionnement moyenne.

**SPECIFICATIONS BY END MOUNT
ESPECIFICACIONES POR TIPO DE MONTAJE
SPÉCIFICATIONS PAR FIXATION DES EXTRÉMITÉS**

Gabriel	Mounting		Lengths			Dust Tube	Recoil Cutoff	Controls*	
	Upper	Lower	Extended	Collapsed	Stroke			Rebound	Compression
G63489	S29	BP11	14.42	9.64	4.78				
81668	S29	BP11	14.32	9.56	4.76				
77489	S29	BP11	14.36	9.55	4.81				
61544	S29	BP11	14.54	9.75	4.79				
58489	S29	BP11	14.64	9.61	5.03				
G63622	S36	EB1	15.32	10.29	5.03				
G63614	S36	EB1	15.09	10.06	5.03				
81744	S36	EB1	14.52	9.76	4.76				
77807	S36	EB1	15.33	10.34	4.99				
77614	S36	EB1	15.04	10.05	4.99				
77608	S36	EB1	14.45	9.64	4.81				
61591	S36	EB1	14.47	9.71	4.76				
58929	S36	EB1	14.54	9.76	4.78				
58807	S36	EB1	15.24	10.11	5.13				
58622	S36	EB1	15.04	10.16	4.88				
34076	S36	EB1	14.59	9.87	n/a				
NM1005	S36	EB1	15.32	10.29	5.03				
G63386	S36	ES25	16.11	10.58	5.53				
81394	S36	ES25	17.47	11.21	6.26				
G63414	S36	ES41	15.09	10.06	5.03				
61520	S36	ES41	15.34	10.31	5.03				
G63623	S36	ES83	22.57	14.29	8.28				
81828	S36	ES83	22.72	14.21	8.51				
77414	S36	ES83	15.33	10.34	4.99				
61646	S36	ES83	22.57	14.29	8.28				
58623	S36	ES83	22.54	13.91	8.63				
NM1010	S36	ES83	22.57	14.29	8.28				
77714	S38	BP7	15.34	9.84	5.50				
77949	S38	BP27	16.16	10.67	5.49				
77716	S38	ES26	15.32	9.84	5.48				
G64009	S38	ES34	23.29	14.25	9.04				
G63886	S38	ES34	20.8	13.36	7.44				
G63674	S38	ES34	23.39	14.36	9.03				
G63673	S38	ES34	22.3	13.77	8.53				
G63661	S38	ES34	13.8	9.52	4.28				
81928	S38	ES34	13.78	9.52	4.26				

* Damping force, in pounds, to either extend or collapse the shock absorber at an average operating velocity. Fuerza de amortiguación en libras para extender o comprimir el amortiguador a una velocidad de operación promedio. La puissance d'amortissement en poids de l'amortisseur, soit comprimé, soit détendu, à une vitesse de fonctionnement moyenne.

**SPECIFICATIONS BY END MOUNT
ESPECIFICACIONES POR TIPO DE MONTAJE
SPÉCIFICATIONS PAR FIXATION DES EXTRÉMITÉS**

Gabriel	Mounting		Lengths			Dust Tube	Recoil Cutoff	Controls*	
	Upper	Lower	Extended	Collapsed	Stroke			Rebound	Compression
81919	S38	ES34	22.3	13.54	8.76				
77951	S38	ES34	20.5	13	7.50				
77948	S38	ES34	23.5	14.75	8.75				
77674	S38	ES34	23.27	14.27	9.00				
77673	S38	ES34	22.38	13.84	8.54				
61680	S38	ES34	20.83	13.39	7.44				
61635	S38	ES34	23.27	14.24	9.03				
61634	S38	ES34	22.3	13.77	8.53				
61599	S38	ES34	13.8	9.52	4.28				
G64168	S38	ES34	23.58	16.66	6.92				
NM1009	S38	ES34	20.8	13.36	7.44				
77623	S38	ES83	22.38	13.84	8.54				
77980	S38	ES204	23	14.39	8.61				
83114	S40	ES35	23.02	13.78	9.24	YES	NO	450	102
83162	S40	ES190	24.35	14.69	9.67	YES	NO	877	52
85332	S42	ES36	20.64	12.98	7.66				
83244	S43	ES175	27.28	16.38	10.9	YES	NO	502	112
85182	S43	S43	26.86	16.04	10.82	YES	NO	708	232
G63610	S47	EB1	21.95	13.17	8.78				
61592	S47	EB1	21.45	13.17	8.28				
G64043	S61	BP38	14.09	9.68	4.41				
NM1020	S61	BP38	14.09	9.68	4.41				
G63714	S62	BP7	15.39	9.86	5.53				
81912	S62	BP7	15.48	9.87	5.61				
61611	S62	BP7	15.48	9.95	5.53				
58714	S62	BP7	15.26	9.98	5.28				
G63716	S62	ES26	16.39	9.86	6.53				
81914	S62	ES26	15.48	9.87	5.61				
61613	S62	ES26	15.48	9.95	5.53				
G63969	S62	ES34	20.75	13.31	7.44				
85649	S62	ES34	23.16	16.46	6.7	YES	NO	875	421
77967	S62	ES34	20.75	13.13	7.62				
61714	S62	ES34	23.36	14.22	9.14				
G64011	S62	ES87	23.36	14.21	9.15				
58944	S62	ES204	20.73	13.35	7.38				
G56778	S68	CL1	21.37	14.37	7				
G51856	S92	LU1	21.18	15.11	6.07				
G57802	TMR4S	CL3	17.20	9.96	7.24				

* Damping force, in pounds, to either extend or collapse the shock absorber at an average operating velocity. Fuerza de amortiguación en libras para extender o comprimir el amortiguador a una velocidad de operación promedio. La puissance d'amortissement en poids de l'amortisseur, soit comprimé, soit détendu, à une vitesse de fonctionnement moyenne.

**SPECIFICATIONS BY END MOUNT
ESPECIFICACIONES POR TIPO DE MONTAJE
SPÉCIFICATIONS PAR FIXATION DES EXTRÉMITÉS**

Gabriel	Mounting		Lengths			Dust Tube	Recoil Cutoff	Controls*	
	Upper	Lower	Extended	Collapsed	Stroke			Rebound	Compression
G57206	TMT3S	CL1	22.71	15.74	6.97				
G57816	TMT3S	LP4	27.17	18.98	8.19				
G57147	TMT3S	LU1	21.18	15.11	6.06				
G57801	TMU2B1S	LP4	26.73	19.49	7.24				
G57800	TMU2B1S	LP4	26.73	19.49	7.24				
G57853	TMU3S	CL1	21.28	n/a	n/a				
G57852	TMU3S	CL1	21.28	n/a	n/a				

* Damping force, in pounds, to either extend or collapse the shock absorber at an average operating velocity. Fuerza de amortiguación en libras para extender o comprimir el amortiguador a una velocidad de operación promedio. La puissance d'amortissement en poids de l'amortisseur, soit comprimé, soit détendu, à une vitesse de fonctionnement moyenne.

**SPECIFICATIONS BY PART NUMBER
ESPECIFICACIONES POR NÚMERO DE PARTE
SPÉCIFICATIONS PAR NUMÉRO DE PIÈCE**

Gabriel	Mounting		Lengths			Dust Tube	Recoil Cutoff	Controls*	
	Upper	Lower	Extended	Collapsed	Stroke			Rebound	Compression
14017	EB1	EB1	24.04	14.43	9.61				
14072	ES83	EB18	28.22	16.49	11.73				
34036	EB1	ES24	14.16	9.53	4.63				
34052	S1	BP13	13.62	9	4.62				
34058	S12	ES3	17.13	11.01	n/a				
34073	S1	BP7	14.29	9.37	4.92				
34076	S36	EB1	14.59	9.87	n/a				
43048	EB1	EB1	20.45	12.62	7.83				
43058	EB1	ES25	19.95	12.37	7.58				
43085	EB4	ES27	20.61	12.78	n/a				
43099	S1	ES25	19.17	11.77	7.40				
43111	EB7	ES34	22.9	13.82	9.08				
43140	S1	EB1	20.92	12.84	8.08				
43163	BP14	ES34	25.05	15.69	9.36				
43167	EB1	ES83	22.99	13.88	9.11				
43180	BP8	ES34	23.55	14.19	9.36				
43181	ES34	ES34	24.24	14.88	9.36				
49107	ES24	ES24	19.27	12.29	6.98				
49127	EB1	ES25	19.87	12.63	7.24				
49149	ES27	EB4	24.93	15.64	9.29				
49155	EB1	ES34	23.27	14.29	8.98				
49162	ES24	ES24	20.02	12.79	7.23				
49173	S1	ES25	19.24	12.01	7.23				
49178	S1	ES25	23.12	13.89	9.23				
49203	S1	EB1	20.24	12.51	7.73				
49205	S1	EB1	21.12	13.13	7.99				
49212	ES27	ES27	21.02	13.29	7.73				
49218	BP14	ES34	26.34	16.36	9.98				
49231	BP14	ES34	24.27	14.79	9.48				
49235	ES34	ES34	24.77	15.04	9.73				
49310	EB1	EB1	20.35	12.75	7.60				
49311	EB1	EB1	22.44	14	8.44				
58357	ES24	ES24	14.68	10.06	4.62				
58359	S1	BP13	13.92	9.14	4.78				
58403	ES26	ES26	24.48	14.95	9.53				
58412	ES34	ES34	26.68	16.18	10.50				
58488	BP14	ES34	26.69	16.02	10.63				

* Damping force, in pounds, to either extend or collapse the shock absorber at an average operating velocity. Fuerza de amortiguación en libras para extender o comprimir el amortiguador a una velocidad de operación promedio. La puissance d'amortissement en poids de l'amortisseur, soit comprimé, soit détendu, à une vitesse de fonctionnement moyenne.

**SPECIFICATIONS BY PART NUMBER
ESPECIFICACIONES POR NÚMERO DE PARTE
SPÉCIFICATIONS PAR NUMÉRO DE PIÈCE**

Gabriel	Mounting		Lengths			Dust Tube	Recoil Cutoff	Controls*	
	Upper	Lower	Extended	Collapsed	Stroke			Rebound	Compression
58489	S29	BP11	14.64	9.61	5.03				
58609	ES126	ES45	16.49	11.05	5.44				
58622	S36	EB1	15.04	10.16	4.88				
58623	S36	ES83	22.54	13.91	8.63				
58638	BP14	ES34	23.87	14.49	9.38				
58662	ES34	ES34	24.68	15.36	9.32				
58807	S36	EB1	15.24	10.11	5.13				
58808	EB1	ES83	28.38	16.75	11.63				
58809	EB1	ES83	23.65	14.53	9.12				
58810	EB1	ES83	31.42	18.42	13.00				
58817	S12	ES60	15.59	10.96	4.63				
58929	S36	EB1	14.54	9.76	4.78				
58930	ES34	ES34	22.81	14.06	8.75				
58944	S62	ES204	20.73	13.35	7.38				
61500	EB1	EB1	20.23	12.37	7.86				
61506	EB1	EB1	21.86	13.58	8.28				
61516	ES31	ES24	18.23	11.37	6.86				
61517	ES24	ES24	14.98	9.95	5.03				
61518	S1	ES25	18.73	11.7	7.03				
61519	EB1	ES25	19.98	12.45	7.53				
61520	S36	ES41	15.34	10.31	5.03				
61521	S12	ES25	16.45	10.67	5.78				
61522	ES27	ES27	20.49	12.63	7.86				
61523	S1	BP13	13.7	8.92	4.78				
61524	EB1	ES34	23.26	14.23	9.03				
61525	EB1	ES24	15.01	9.95	5.06				
61530	EB1	ES83	25.48	15.2	10.28				
61542	ES126	ES128	16.73	10.95	5.78				
61543	BP14	ES34	26.76	16.23	10.53				
61544	S29	BP11	14.54	9.75	4.79				
61546	S1	EB1	18.45	11.67	6.78				
61547	EB1	ES83	23.01	14.07	8.94				
61554	EB1	ES83	21.48	13.2	8.28				
61555	S12	BP7	14.14	9.11	5.03				
61565	BP14	ES34	24.26	14.73	9.53				
61591	S36	EB1	14.47	9.71	4.76				
61592	S47	EB1	21.45	13.17	8.28				

* Damping force, in pounds, to either extend or collapse the shock absorber at an average operating velocity. Fuerza de amortiguación en libras para extender o comprimir el amortiguador a una velocidad de operación promedio. La puissance d'amortissement en poids de l'amortisseur, soit comprimé, soit détendu, à une vitesse de fonctionnement moyenne.

**SPECIFICATIONS BY PART NUMBER
ESPECIFICACIONES POR NÚMERO DE PARTE
SPÉCIFICATIONS PAR NUMÉRO DE PIÈCE**

Gabriel	Mounting		Lengths			Dust Tube	Recoil Cutoff	Controls*	
	Upper	Lower	Extended	Collapsed	Stroke			Rebound	Compression
61599	S38	ES34	13.8	9.52	4.28				
61600	ES34	ES34	24.51	14.98	9.53				
61614	ES41	ES41	22.98	13.95	9.03				
61632	EB4	EB4	20.79	13.01	7.78				
61634	S38	ES34	22.3	13.77	8.53				
61635	S38	ES34	23.27	14.24	9.03				
61641	S12	BP11	14.7	10.17	4.53				
61642	ES34	ES34	26.76	15.98	10.78				
61646	S36	ES83	22.57	14.29	8.28				
61654	EB1	ES83	28.76	16.98	11.78				
61655	ES83	ES83	23.01	14.07	8.94				
61656	ES83	ES83	31.51	18.48	13.03				
61663	S12	ES60	15.7	10.92	4.78				
61680	S38	ES34	20.83	13.39	7.44				
61682	EB1	ES83	31.36	18.67	12.69				
61683	S11	LU1	15.07	10.44	4.63				
61684	S11	BP9	12.82	8.88	3.94				
61685	S11	BP9	14.12	9.68	4.44				
61687	BP14	ES34	23.87	14.68	9.19				
61710	ES34	ES34	27.58	17.14	10.44				
61713	EB1	ES83	26.94	16	10.94				
61714	S62	ES34	23.36	14.22	9.14				
61716	ES34	ES34	26.5	16.33	10.17				
77375	S12	BP7	14.14	9.04	5.10				
77403	ES26	ES26	24.31	14.78	9.53				
77412	ES34	ES34	26.77	16.26	10.51				
77414	S36	ES83	15.33	10.34	4.99				
77455	ES83	ES83	22.92	13.9	9.02				
77461	EB1	ES83	25.39	15.18	10.21				
77488	BP14	ES34	26.77	16.26	10.51				
77489	S29	BP11	14.36	9.55	4.81				
77607	BP14	ES83	25.39	15.18	10.21				
77608	S36	EB1	14.45	9.64	4.81				
77609	ES126	ES128	16.43	10.95	5.48				
77614	S36	EB1	15.04	10.05	4.99				
77623	S38	ES83	22.38	13.84	8.54				
77638	BP14	ES34	24.31	14.78	9.53				

* Damping force, in pounds, to either extend or collapse the shock absorber at an average operating velocity. Fuerza de amortiguación en libras para extender o comprimir el amortiguador a una velocidad de operación promedio. La puissance d'amortissement en poids de l'amortisseur, soit comprimé, soit détendu, à une vitesse de fonctionnement moyenne.

**SPECIFICATIONS BY PART NUMBER
ESPECIFICACIONES POR NÚMERO DE PARTE
SPÉCIFICATIONS PAR NUMÉRO DE PIÈCE**

Gabriel	Mounting		Lengths			Dust Tube	Recoil Cutoff	Controls*	
	Upper	Lower	Extended	Collapsed	Stroke			Rebound	Compression
77661	S12	ES34	13.72	9.5	4.22				
77662	ES34	ES34	24.31	14.78	9.53				
77673	S38	ES34	22.38	13.84	8.54				
77674	S38	ES34	23.27	14.27	9.00				
77675	ES34	ES34	26.25	15.74	10.51				
77783	S12	BP11	14.64	10.12	4.52				
77807	S36	EB1	15.33	10.34	4.99				
77808	EB1	ES83	28.73	16.92	11.81				
77809	EB1	ES83	22.92	13.9	9.02				
77810	EB1	ES83	31.53	18.5	13.03				
77817	S12	ES60	15.73	10.94	4.79				
77837	BP14	ES83	28.73	16.92	11.81				
77907	EB1	EB1	19.87	12.23	7.64				
77948	S38	ES34	23.5	14.75	8.75				
77950	ES34	ES34	27.5	17.5	10.00				
77951	S38	ES34	20.5	13	7.50				
77952	EB1	ES83	29.68	17.43	12.25				
77967	S62	ES34	20.75	13.13	7.62				
77968	EB1	ES83	24.71	15.09	9.62				
77969	EB1	ES83	25.43	15.81	9.62				
77976	ES34	ES34	24.84	16.07	8.76				
77980	S38	ES204	23	14.39	8.61				
77986	EB1	ES48	31.01	18.65	12.36				
77987	EB1	ES48	27.24	16.38	10.86				
77988	EB1	ES56	30.12	17.97	12.14				
81039	EB1	ES24	14.73	9.62	5.11				
81082	EB1	ES83	23.23	13.87	9.36				
81091	ES27	EB4	25.14	15.28	9.86				
81096	S1	BP13	13.7	8.84	4.86				
81113	ES31	ES24	18.23	11.37	6.86				
81147	EB1	EB1	20.23	12.37	7.86				
81164	EB1	ES34	23.23	13.87	9.36				
81242	S1	ES25	19.2	11.59	7.61				
81270	S1	S1	17.67	10.56	7.11				
81318	EB1	EB1	22.73	13.87	8.86				
81340	S1	EB1	20.7	12.34	8.36				
81342	ES27	EB4	28.89	16.78	12.11				

* Damping force, in pounds, to either extend or collapse the shock absorber at an average operating velocity. Fuerza de amortiguación en libras para extender o comprimir el amortiguador a una velocidad de operación promedio. La puissance d'amortissement en poids de l'amortisseur, soit comprimé, soit détendu, à une vitesse de fonctionnement moyenne.

SPECIFICATIONS BY PART NUMBER
ESPECIFICACIONES POR NÚMERO DE PARTE
SPÉCIFICATIONS PAR NUMÉRO DE PIÈCE

Gabriel	Mounting		Lengths			Dust Tube	Recoil Cutoff	Controls*	
	Upper	Lower	Extended	Collapsed	Stroke			Rebound	Compression
81394	S36	ES25	17.47	11.21	6.26				
81484	EB1	ES25	20.23	12.37	7.86				
81490	S12	ES83	14.85	9.84	5.01				
81496	ES27	ES27	20.49	12.63	7.86				
81510	EB1	ES83	25.73	15.12	10.61				
81667	BP14	ES34	26.95	16.19	10.76				
81668	S29	BP11	14.32	9.56	4.76				
81676	EB1	EB1	17.73	11.12	6.61				
81710	EB1	ES83	21.73	13.12	8.61				
81713	S29	BP7	14.42	9.31	5.11				
81726	ES126	ES128	16.48	10.87	5.61				
81744	S36	EB1	14.52	9.76	4.76				
81821	ES83	ES83	23.23	13.87	9.36				
81825	EB4	EB4	21.1	12.99	8.11				
81828	S36	ES83	22.72	14.21	8.51				
81834	S1	BP13	15.7	9.84	5.86				
81919	S38	ES34	22.3	13.54	8.76				
81920	S12	BP11	14.71	10.1	4.61				
81921	ES34	ES34	26.76	15.67	11.09				
81925	S12	ES7	14.7	9.59	5.11				
81928	S38	ES34	13.78	9.52	4.26				
82003	ES24	ES24	18.55	11.44	7.11				
82007	EB1	EB1	18.23	11.37	6.86				
82012	BP6	ES25	16.04	10.53	5.51				
82026	S1	S1	13.42	8.56	4.86				
82035	ES24	EB1	14.64	9.53	5.11				
82047	EB1	EB1	20.23	12.37	7.86				
82065	EB4	EB4	19.04	11.93	7.11				
82066	S1	EB1	22.7	13.34	9.36				
82086	ES1	ES1	25.54	14.93	10.61				
82155	S1	EB1	20.7	12.34	8.36				
83006	ES149	EB1	10.71	8.52	2.78	YES	YES	525	182
83021	ES10	ES10	9.41	7.4	2.01	YES	YES	745	315
83025	ES163	ES163	8.02	6.53	1.48	YES	YES	710	230
83039	ES149	ES149	10.44	8.4	3				
83040	ES171	ES172	10.44	8.4	3	YES	YES	876	326
83054	ES185	ES185	10.28	7.56	2.72	YES	YES	1004	184

* Damping force, in pounds, to either extend or collapse the shock absorber at an average operating velocity. Fuerza de amortiguación en libras para extender o comprimir el amortiguador a una velocidad de operación promedio. La puissance d'amortissement en poids de l'amortisseur, soit comprimé, soit détendu, à une vitesse de fonctionnement moyenne.

**SPECIFICATIONS BY PART NUMBER
ESPECIFICACIONES POR NÚMERO DE PARTE
SPÉCIFICATIONS PAR NUMÉRO DE PIÈCE**

Gabriel	Mounting		Lengths			Dust Tube	Recoil Cutoff	Controls*	
	Upper	Lower	Extended	Collapsed	Stroke			Rebound	Compression
83066	ES153	ES153	11.15	9.2	2.78	YES	YES	599	221
83101	ES90	ES90	24.63	15.13	9.49	YES	YES	481	142
83102	S21	S21	22.89	13.54	9.35				
83103	S21	S21	19.66	11.93	7.74	YES	YES	517	301
83112	ES36	S42	21.52	13.41	8.11				
83114	S40	ES35	23.02	13.78	9.24	YES	NO	450	102
83119	EB4	ES165	23.96	14.84	9.12				
83120	ES120	S21	22.17	13.66	8.51	YES	YES	779	164
83122	ES36	ES36	25.28	15.79	9.49	YES	YES	661	201
83123	ES36	ES36	26.65	16.41	10.24	YES	YES	589	119
83124	ES36	ES36	21.65	13.77	7.88	YES	YES	750	137
83126	ES36	ES36	24.41	15.27	9.14	YES	YES	625	115
83127	ES36	ES36	20.16	13.14	7.01	YES	YES	940	218
83131	ES83	ES83	27.8	18.18	9.62				
83134	S21	ES36	22.27	13.51	8.77	YES	NO	430	49
83135	ES90	ES90	19.49	12.38	7.11	YES	NO	519	121
83136	S21	S21	29.31	16.8	12.51	YES	NO	914	65
83137	ES36	ES36	30.04	17.79	12.25	YES	YES	517	132
83140	EB3	EB3	25.28	15.53	9.75	YES	NO	738	88
83141	EB3	EB3	25.27	15.52	9.75	YES	NO	408	113
83142	ES162	S42	23.92	14.49	9.43	YES	YES	367	131
83143	ES162	S42	21.92	13.51	8.41	YES	YES	403	137
83144	ES36	ES36	23.78	15.03	8.74				
83147	ES179	ES179	28.54	17.4	11.15				
83148	ES179	ES179	30	17.83	12.17				
83154	ES120	S21	20.78	12.72	8.06	YES	YES	599	140
83157	ES36	ES90	26.38	15.76	10.61	YES	NO	446	303
83159	EB2	EB2	21.85	13.56	8.29	YES	NO	658	149
83160	ES128	ES36	24.31	14.9	9.37	YES	YES	920	161
83162	S40	ES190	24.35	14.69	9.67	YES	NO	877	52
83163	ES175	ES175	20.75	13.01	7.74	YES	NO	828	98
83164	ES36	ES165	24.22	14.59	9.63	YES	NO	426	274
83166	ES179	ES179	25.28	15.78	9.49	YES	YES	622	132
83168	ES179	ES179	25.28	15.78	9.49				
83169	ES90	ES90	18.55	11.91	6.64	YES	NO	599	171
83175	ES175	ES175	20.48	13.19	7.29				
83180	ES90	ES83	30.2	21.24	8.96	YES	NO	909	204

* Damping force, in pounds, to either extend or collapse the shock absorber at an average operating velocity. Fuerza de amortiguación en libras para extender o comprimir el amortiguador a una velocidad de operación promedio. La puissance d'amortissement en poids de l'amortisseur, soit comprimé, soit détendu, à une vitesse de fonctionnement moyenne.

**SPECIFICATIONS BY PART NUMBER
ESPECIFICACIONES POR NÚMERO DE PARTE
SPÉCIFICATIONS PAR NUMÉRO DE PIÈCE**

Gabriel	Mounting		Lengths			Dust Tube	Recoil Cutoff	Controls*	
	Upper	Lower	Extended	Collapsed	Stroke			Rebound	Compression
83203	ES36	ES36	17.1	11.36	5.74				
83207	ES36	ES36	21.64	13.61	8.03				
83209	ES36	ES36	29.64	17.61	12.03	YES	YES	670	78
83215	EB3	EB3	26.64	16.36	10.28	YES	YES	697	108
83216	EB2	EB2	23.51	14.48	9.03	YES	YES	776	262
83221	ES36	ES36	24.01	14.73	9.28	YES	YES	599	153
83225	EB3	EB3	24.14	15.11	9.03	YES	YES	482	159
83243	ES175	ES175	24.41	15.26	9.15	YES	YES	296	170
83303	EB7	ES36	24.86	15.08	9.78				
83308	EB2	EB2	25.14	15.36	9.78	YES	YES	445	180
83309	EB2	EB2	28.64	17.11	11.53				
83312	EB2	EB2	26.64	16.11	10.53	YES	YES	527	152
83314	EB2	EB2	30.64	18.11	12.53				
83317	S16	ES90	27.03	16	11.34	YES	YES		
83364	ES90	ES83	24.06	15.07	8.99	YES	YES	855	206
83391	ES190	ES190	25.52	15.61	9.91	YES	NO	590	105
83395	S21	ES178	27.19	16.28	10.91	YES	NO	616	105
83397	ES175	ES175	18.67	11.91	6.76	YES	NO	303	101
83398	ES175	ES175	23.23	15.38	7.85	YES	YES	293	168
83456	S21	S21	24.03	14.25	9.78	YES	YES	566	80
83515	S1	EB2	23.34	13.89	9.45	YES	NO	643	205
83518	S1	EB2	24.4	14.26	10.14	YES	NO	153	82
83519	EB2	EB2	23.83	14.35	9.48	YES	NO	292	132
83613	S16	S16	21.04	12.76	8.28	YES	YES	601	242
85000	ES36	ES36	17.28	11.5	5.78				
85001	EB3	EB3	26.3	16.39	9.92	YES	NO	1202	186
85003	ES90	ES90	25.42	15.63	9.79				
85005	ES36	ES36	24.76	15.24	9.52	YES	YES	1019	219
85006	ES36	ES36	28.54	17.13	11.41	YES	YES	1019	219
85007	EB3	EB3	24.33	15.4	8.93	YES	YES	1008	171
85009	S21	ES36	23.56	14.4	9.16	YES	YES	857	144
85010	ES36	ES36	26.8	16.26	10.54	YES	YES	1019	219
85012	EB2	EB2	21.02	13.23	7.79	YES	NO	523	199
85013	ES36	ES36	29.79	17.76	12.04	YES	YES	1019	219
85014	ES36	ES36	21.76	13.74	8.02				
85029	ES36	ES36	20.54	13.11	7.43	YES	YES	1019	219
85031	ES176	EB2	25.63	15.87	9.76	YES	NO	941	257
85036	ES36	ES36	26.38	16.29	10.09				

* Damping force, in pounds, to either extend or collapse the shock absorber at an average operating velocity. Fuerza de amortiguación en libras para extender o comprimir el amortiguador a una velocidad de operación promedio. La puissance d'amortissement en poids de l'amortisseur, soit comprimé, soit détendu, à une vitesse de fonctionnement moyenne.

**SPECIFICATIONS BY PART NUMBER
ESPECIFICACIONES POR NÚMERO DE PARTE
SPÉCIFICATIONS PAR NUMÉRO DE PIÈCE**

Gabriel	Mounting		Lengths			Dust Tube	Recoil Cutoff	Controls*	
	Upper	Lower	Extended	Collapsed	Stroke			Rebound	Compression
85043	ES36	ES36	27.63	16.85	10.78	YES	YES	628	163
85058	ES36	ES36	22.67	14.26	8.41	YES	YES	722	114
85069	S21	S21	26.31	15.97	10.33	YES	YES	762	255
85071	S21	S21	25.57	15.02	10.55	YES	NO	610	107
85072	ES36	ES176	24.17	14.81	9.36	YES	YES	1387	305
85084	ES174	ES136	20.59	13.03	7.57	YES	NO	1145	407
85106	ES150	ES150	20.03	12.89	7.14	YES	YES	1054	109
85124	S21	S21	20.91	12.9	8.01	YES	YES	1086	222
85125	ES158	ES159	26.9	16.64	10.26	YES	YES	1479	183
85180	ES150	ES36	20.94	13.83	7.11				
85181	ES150	ES150	26.33	17.06	9.27				
85182	S43	S43	26.86	16.04	10.82	YES	NO	708	232
85188	ES161	ES162	25.31	15.52	9.79	YES	YES	1074	255
85300	EB3	EB3	17.98	12.21	5.78				
85304	EB3	EB3	22.25	14.22	8.03				
85307	EB3	EB3	23.98	15.08	8.89				
85310	S21	S21	18.63	11.71	6.92	YES	YES	1379	578
85311	S21	EB3	23.95	14.79	9.16	YES	YES	764	254
85316	S21	ES36	20.61	12.82	7.8				
85329	EB3	EB3	24.52	15.48	9.04				
85331	ES158	ES159	19.62	12.85	6.77	YES	YES	1757	396
85332	S42	ES36	20.64	12.98	7.66				
85335	ES158	ES159	19.62	12.85	6.77	YES	YES	827	107
85642	ES177	ES90	22.52	14.52	8	YES	YES	1920	309
85649	S62	ES34	23.16	16.46	6.7	YES	NO	875	421
85650	ES136	ES34	24.88	16.35	8.53	YES	NO	941	463
85656	ES90	ES90	26.49	16.94	10.75	YES	YES	1225	274
85670	ES175	ES175	23.19	14.67	8.52	YES	YES	591	176
85705	S21	S21	23.62	14.23	9.39				
85711	S21	EB3	24.54	15.26	9.27				
85716	EB3	EB3	21.99	14.33	7.66				
85724	ES158	ES159	22.81	14.51	8.3	YES	YES	1235	454
85734	EB3	EB3	20.73	13.7	7.03	YES	YES	1288	227
85736	EB3	EB3	23.61	15.2	8.41				
85900	S21	S21	17.33	11.23	6.11	YES	YES	1467	337
85902	S21	S21	19.03	12.09	6.93	YES	YES	1441	267
85909	ES36	ES36	24.25	15.19	9.06				

* Damping force, in pounds, to either extend or collapse the shock absorber at an average operating velocity. Fuerza de amortiguación en libras para extender o comprimir el amortiguador a una velocidad de operación promedio. La puissance d'amortissement en poids de l'amortisseur, soit comprimé, soit détendu, à une vitesse de fonctionnement moyenne.

**SPECIFICATIONS BY PART NUMBER
ESPECIFICACIONES POR NÚMERO DE PARTE
SPÉCIFICATIONS PAR NUMÉRO DE PIÈCE**

Gabriel	Mounting		Lengths			Dust Tube	Recoil Cutoff	Controls*	
	Upper	Lower	Extended	Collapsed	Stroke			Rebound	Compression
85910	ES36	ES36	20.79	13.54	7.25				
85918	ES150	ES150	22.97	14.58	8.39	YES	NO	1726	412
85919	ES36	ES36	22.52	14.33	8.19	YES	YES	1265	121
85920	ES150	ES150	21.16	13.57	7.59	YES	NO	845	49
85921	S21	ES36	22.07	13.57	8.5	YES	NO	2053	339
85923	ES177	ES161	22.52	14.52	8	YES	YES	1940	221
85927	ES90	ES90	24.76	15.47	9.3				
85928	ES90	ES90	20.31	13.24	7.07	YES	NO	957	229
85932	ES178	ES150	21.26	13.7	7.56	YES	YES	1102	430
85956	ES183	ES184	30.65	18.77	11.88	YES	YES	979	373
85957	ES90	ES90	20.78	13.19	7.6	YES	NO	1583	138
85958	ES150	ES150	22.89	14.5	8.39	YES	YES	1926	281
85959	ES150	ES150	21.16	13.57	7.59	YES	YES	1021	123
85976	ES36	ES36	29.92	18.12	11.8	YES	YES	582	138
85978	ES179	ES179	29.84	18.16	11.69				
85979	ES36	ES36	31.18	18.66	12.52				
85988	S21	EB3	23.84	14.87	8.97	YES	YES	1200	138
85989	ES174	ES136	20.78	13.15	7.63	YES	NO	1812	351
85995	ES90	ES36	23.5	14.52	8.98				
89405	ES36	ES36	26.3	16.57	9.73	YES	YES	1009‡	249
89406	ES36	ES36	24.76	15.82	8.93	YES	YES	658‡	125
89407	ES36	ES36	21.61	14.17	7.45	YES	YES	652‡	218
89409	EB2	EB2	27.13	16.92	10.2	YES	YES	567‡	165
89410	EB3	EB3	26.34	16.57	9.77	YES	NO	1185‡	182
89413	EB2	EB2	20.94	13.53	7.41	YES	NO	536‡	201
89414	ES36	ES36	29.65	18.18	11.46	YES	YES	1045‡	217
89419	EB3	EB3	18.04	12.67	5.36				
89423	S21	S21	18.67	12.21	6.46	YES	YES	1352‡	573
89424	S21	EB3	23.73	15.14	8.59	YES	YES	794‡	253
89425	EB3	EB3	26.5	16.93	9.57				
89430	ES36	ES36	24.61	15.66	8.94	YES	YES	1462‡	279
89431	ES36	ES36	22.41	14.16	8.25	YES	NO	751‡	211
89436	ES36	ES36	17.24	12.04	5.2				
89443	ES158	ES159	22.19	14.66	7.53	YES	YES	1206‡	466
89447	S21	S21	23.63	14.69	8.94	YES	YES	702‡	241
89449	ES150	ES150	23.25	14.9	8.35	YES	NO	1519‡	324
89453	ES178	ES150	21.14	13.93	7.21	YES	YES	860‡	435

* Damping force, in pounds, to either extend or collapse the shock absorber at an average operating velocity. Fuerza de amortiguación en libras para extender o comprimir el amortiguador a una velocidad de operación promedio. La puissance d'amortissement en poids de l'amortisseur, soit comprimé, soit détendu, à une vitesse de fonctionnement moyenne.

**SPECIFICATIONS BY PART NUMBER
ESPECIFICACIONES POR NÚMERO DE PARTE
SPÉCIFICATIONS PAR NUMÉRO DE PIÈCE**

Gabriel	Mounting		Lengths			Dust Tube	Recoil Cutoff	Controls*	
	Upper	Lower	Extended	Collapsed	Stroke			Rebound	Compression
89455	S21	S21	26.31	16.03	10.28	YES	YES	791‡	276
89458	ES177	ES161	22.48	14.6	7.88	YES	YES	1575‡	222
89460	ES174	ES136	20.58	13.03	7.55	YES	NO	997‡	384
89503	ES150	ES150	21.28	13.72	7.56	YES	NO	1033‡	123
646218	ES36	ES36	22.49	14.11	8.38				
6802SE	S1	S1	20.02	12.11	7.91				
6803SE	S1	S1	22.52	13.36	9.16				
6804SE	EB1	EB1	24.08	14.67	9.41				
6828SE	EB1	EB1	21.23	12.87	8.36				
6847SE	EB1	ES65	23	13.83	9.17				
6850SE	EB1	S1	23.3	13.77	9.53				
6853SE	EB1	ES24	19.33	12.05	7.28				
6854SE	EB1	EB1	23.03	14.27	8.76				
6855SE	EB1	EB1	23.83	14.3	9.53				
6856SE	S1	EB1	27.3	15.77	11.53				
G56778	S68	CL1	21.37	14.37	7				
G57206	TMT3S	CL1	22.71	15.74	6.97				
G57800	TMU2B1S	LP4	26.73	19.49	7.24				
G57801	TMU2B1S	LP4	26.73	19.49	7.24				
G57802	TMR4S	CL3	17.20	9.96	7.24				
G57816	TMT3S	LP4	27.17	18.98	8.19				
G57852	TMU3S	CL1	21.28	n/a	n/a				
G57853	TMU3S	CL1	21.28	n/a	n/a				
G63183	EB4	EB4	20.79	13.01	7.78				
G63299	EB1	EB1	18.08	11.55	6.53				
G63306	ES24	ES24	19.85	12.57	7.28				
G63347	ES31	ES24	18.08	11.55	6.53				
G63349	EB1	ES34	23.33	14.3	9.03				
G63350	S1	ES25	18.82	11.79	7.03				
G63353	ES27	EB4	24.74	14.96	9.78				
G63355	EB1	ES24	14.98	9.95	5.03				
G63357	ES24	ES24	14.98	9.95	5.03				
G63359	S1	BP13	13.7	8.92	4.78				
G63360	S1	BP13	15.7	9.92	5.78				
G63366	ES34	ES34	23.26	14.23	9.03				
G63375	S12	BP7	14.14	9.11	5.03				
G63377	EB1	ES25	20.08	12.55	7.53				

* Damping force, in pounds, to either extend or collapse the shock absorber at an average operating velocity. Fuerza de amortiguación en libras para extender o comprimir el amortiguador a una velocidad de operación promedio. La puissance d'amortissement en poids de l'amortisseur, soit comprimé, soit détendu, à une vitesse de fonctionnement moyenne.

**SPECIFICATIONS BY PART NUMBER
ESPECIFICACIONES POR NÚMERO DE PARTE
SPÉCIFICATIONS PAR NUMÉRO DE PIÈCE**

Gabriel	Mounting		Lengths			Dust Tube	Recoil Cutoff	Controls*	
	Upper	Lower	Extended	Collapsed	Stroke			Rebound	Compression
G63386	S36	ES25	16.11	10.58	5.53				
G63387	S1	ES25	23.32	14.04	9.28				
G63394	EB1	ES24	16.01	10.48	5.53				
G63403	ES26	ES26	24.58	14.8	9.78				
G63405	EB1	EB1	20.01	12.48	7.53				
G63409	EB1	ES185	21.48	13.2	8.28				
G63410	S12	EB1	18.55	11.77	6.78				
G63411	ES31	ES26	18.58	11.8	6.78				
G63413	ES27	ES27	20.76	12.98	7.78				
G63419	EB1	EB1	24.08	14.55	9.53				
G63432	S1	EB19	21.11	12.83	8.28				
G63455	ES83	ES83	22.98	13.95	9.03				
G63456	EB1	ES83	26.85	16.07	10.78				
G63461	EB1	ES83	25.51	15.23	10.28				
G63488	BP14	ES34	26.61	16.33	10.28				
G63489	S29	BP11	14.42	9.64	4.78				
G63492	EB1	EB1	22.58	13.8	8.78				
G63605	EB19	ES27	24.24	14.71	9.53				
G63607	BP14	ES83	25.58	15.3	10.28				
G63609	ES126	ES128	16.5	10.97	5.53				
G63610	S47	EB1	21.95	13.17	8.78				
G63614	S36	EB1	15.09	10.06	5.03				
G63622	S36	EB1	15.32	10.29	5.03				
G63623	S36	ES83	22.57	14.29	8.28				
G63625	EB1	ES24	22.56	13.78	8.78				
G63638	BP14	ES34	24.33	14.8	9.53				
G63661	S38	ES34	13.8	9.52	4.28				
G63662	ES34	ES34	24.58	15.05	9.53				
G63671	ES26	ES26	22.48	13.7	8.78				
G63673	S38	ES34	22.3	13.77	8.53				
G63674	S38	ES34	23.39	14.36	9.03				
G63675	ES34	ES34	26.86	16.08	10.78				
G63692	EB1	EB1	27.58	16.3	11.28				
G63783	S12	BP11	14.59	10.21	4.38				
G63808	EB1	ES83	28.86	17.08	11.78				
G63809	EB1	ES83	22.98	13.95	9.03				
G63810	EB1	ES83	31.6	18.57	13.03				

* Damping force, in pounds, to either extend or collapse the shock absorber at an average operating velocity. Fuerza de amortiguación en libras para extender o comprimir el amortiguador a una velocidad de operación promedio. La puissance d'amortissement en poids de l'amortisseur, soit comprimé, soit détendu, à une vitesse de fonctionnement moyenne.

**SPECIFICATIONS BY PART NUMBER
ESPECIFICACIONES POR NÚMERO DE PARTE
SPÉCIFICATIONS PAR NUMÉRO DE PIÈCE**

Gabriel	Mounting		Lengths			Dust Tube	Recoil Cutoff	Controls*	
	Upper	Lower	Extended	Collapsed	Stroke			Rebound	Compression
G63817	S12	ES60	15.8	11.02	4.78				
G63837	BP14	ES83	28.23	17.95	10.28				
G63866	ES34	ES34	22.81	14.12	8.69				
G63886	S38	ES34	20.8	13.36	7.44				
G63888	EB1	ES83	31.36	18.67	12.69				
G63893	S11	LU1	15.07	10.44	4.63				
G63894	S11	BP9	12.82	8.88	3.94				
G63895	S11	BP9	14.12	9.68	4.44				
G63896	BP14	ES34	22.36	13.92	8.44				
G63897	BP14	ES34	23.87	14.68	9.19				
G63918	ES34	ES141	21.25	13.56	7.69				
G63969	S62	ES34	20.75	13.31	7.44				
G63971	ES34	ES34	27.58	17.14	10.44				
G64009	S38	ES34	23.29	14.25	9.04				
G64010	EB1	ES83	26.94	16	10.94				
G64011	S62	ES87	23.36	14.21	9.15				
G64013	ES34	ES34	26.52	16.33	10.19				
G64042	ES18	ES18	14.92	10.55	4.37				
G64043	S61	BP38	14.09	9.68	4.41				
G64089	ES56	ES56	20.43	13.03	7.4				
G64121	ES34	ES34	25.35	16.17	9.18				
G64148	LU1	DS1	18.39	14.09	4.3				
G64164	ES210	ES13	19.95	12.81	7.14				
G64168	S38	ES34	23.58	16.66	6.92				
G64177	ES216	ES19	25.86	16.1	9.76				
G64246	ES123	ES123	20.14	12.73	7.41				
G64268	EB1	ES56	31.34	18.70	12.64				
G64269	EB1	ES56	26.93	16.04	10.89				
NM1001	ES34	ES34	26.86	16.08	10.78				
NM1004	ES34	ES34	24.58	15.05	9.53				
NM1005	S36	EB1	15.32	10.29	5.03				
NM1007	S12	ES60	15.8	11.02	4.78				
NM1008	S12	BP11	14.59	10.21	4.38				
NM1009	S38	ES34	20.8	13.36	7.44				
NM1010	S36	ES83	22.57	14.29	8.28				
NM1014	EB1	ES83	31.36	18.67	12.69				

* Damping force, in pounds, to either extend or collapse the shock absorber at an average operating velocity. Fuerza de amortiguación en libras para extender o comprimir el amortiguador a una velocidad de operación promedio. La puissance d'amortissement en poids de l'amortisseur, soit comprimé, soit détendu, à une vitesse de fonctionnement moyenne.

**SPECIFICATIONS BY PART NUMBER
ESPECIFICACIONES POR NÚMERO DE PARTE
SPÉCIFICATIONS PAR NUMÉRO DE PIÈCE**

Gabriel	Mounting		Lengths			Dust Tube	Recoil Cutoff	Controls*	
	Upper	Lower	Extended	Collapsed	Stroke			Rebound	Compression
NM1015	BP14	ES34	23.87	14.68	9.19				
NM1016	S11	BP9	14.12	9.68	4.44				
NM1019	S11	LU1	15.07	10.44	4.63				
NM1020	S61	BP38	14.09	9.68	4.41				
NM1024	ES34	ES34	26.52	16.33	10.19				
NM1025	BP14	ES34	22.36	13.92	8.44				
NM1028	EB1	ES56	31.34	18.70	12.64				
NM1029	EB1	ES56	26.93	16.04	10.89				

* Damping force, in pounds, to either extend or collapse the shock absorber at an average operating velocity. Fuerza de amortiguación en libras para extender o comprimir el amortiguador a una velocidad de operación promedio. La puissance d'amortissement en poids de l'amortisseur, soit comprimé, soit détendu, à une vitesse de fonctionnement moyenne.



HERE TO HELP



800.999.3903 | ANSWERGARAGE.COM

Gabriel®

THE ORIGINAL

Ride Control AnswerGarage/Tech Line:

800.999.3903

For application, technical and product questions
Monday - Friday, 9AM - 4PM ET

Gabriel Customer Service:

800.251.5932

To place and track orders
Monday - Friday, 7AM - 5PM CT

Watch our Videos:

Gabriel® Shock Selector



Last Mile Delivery



ReadyMount® Installation



MaxControl™ Installation



FIND MORE AT GABRIEL.COM
part lookup, product info, technical help & training



Ride Control, LLC, 39300 Country Club Dr.
Farmington Hills, MI 48331, 248.247.7600